

Operating Instructions

VSeries

Patient Monitors



mindray

Operating Instructions

VSeries

Patient Monitors

mindray

Mindray[®] is a registered trademark of Shenzhen Mindray Bio-Medical Electronics Co., Ltd.

FilterLine[®] is a U.S. registered trademark of Oridion Medical Ltd.

Microstream[®] is a U.S. registered trademark of Oridion Medical Ltd.

Nellcor[™] is a U.S. trademark of Nellcor Puritan Bennett Inc.

Oxiband[®] is a U.S. registered trademark of Nellcor Puritan Bennett Inc.

Durasensor[®] is a U.S. registered trademark of Nellcor Puritan Bennett Inc.

OxiMax[™] is a U.S. trademark of Nellcor Puritan Bennett Inc.

Oxisensor[®] is a U.S. registered trademark of Nellcor Puritan Bennett Inc.

Max-Fast[™] is a trademark of Nellcor Puritan Bennett Inc.

miniMediCO₂[®] is a trademark or registered trademark of Oridion Medical Ltd.

LNCS[®] is a U.S. registered trademark of Masimo Corp.

LNOP[®] is a U.S. registered trademark of Masimo Corp.

Masimo SET[®] is a U.S. registered trademark of Masimo Corp.

Panorama[™] is a U.S. trademark of Mindray, Inc.

Edwards Vigilance[®] is a U.S. registered trademark of Edwards Lifesciences LLC

Camino[®] is a registered trademark of Integra LifeSciences Corporation.

Somanetics[®] and *INVOS*[®] are registered trademarks of Covidien.

Foreword	xiii
Warnings.....	xiv
Cautions	xviii
Notes.....	xxii
Indications for Use	xxiii
Unpacking Information	xxiv
Warranty Statements	xxiv
Service	xxv
Manufacturer's Responsibility	xxv
Symbols and Descriptions.....	xxvi
General Product Description	1 - 1
General Product Description	1 - 2
V Series Monitoring Platform	1 - 2
Interfacing.....	1 - 2
Key Features.....	1 - 3
V 12/V 21 Physical Views	1 - 5
Front View	1 - 5
Rear View	1 - 7
Left Side Panel	1 - 9
Right Side Panel	1 - 10
V Dock Physical Views.....	1 - 11
Back View.....	1 - 11
Right Side View.....	1 - 12
Left Side View.....	1 - 12
VPS Physical Views	1 - 13
Getting Started	2 - 1
Introduction	2 - 2
Powering Unit On/Off.....	2 - 2
Using the V 21 Touch Pad	2 - 2
Main Display.....	2 - 3
System Status Message	2 - 4
Navigation Area	2 - 5
Dialogs.....	2 - 8
List Box	2 - 9
Alarm Icons and Messages	2 - 9
Alarm Icons	2 - 9
Parameter Messages	2 - 9
Keyboard Dialog	2 - 11
Using the Keyboard	2 - 11
Digital Keypad Dialog	2 - 12
Using the Digital Keypad	2 - 12
Message Dialogs.....	2 - 13
Audio Levels Dialog.....	2 - 13
Configuring Audio Levels	2 - 14
Battery Levels Dialog.....	2 - 15
Battery Indicator Colors.....	2 - 15
System Information	2 - 16
Display Setup	3 - 1
Introduction	3 - 2
Display Options Dialog	3 - 2
Navigating to the Display Options Dialog.....	3 - 2
Configuring Display Presets	3 - 3

Editing a Display Preset.....	3 - 8
Locking/Unlocking Presets	3 - 10
Temporarily Editing a Locked Display Preset.....	3 - 11
Restoring a Temporary Preset.....	3 - 12
Copying and Pasting a Display Preset	3 - 12
Renaming a Preset	3 - 12
Renaming an Empty Preset.....	3 - 13
Deleting a Preset.....	3 - 13
Overlapping Waveform.....	3 - 14
Changing IBP Waveform Overlap Settings.....	3 - 15
Undoing an IBP Waveform Overlap	3 - 15
Privacy Mode.....	3 - 15
Screen Lock Mode	3 - 16
Standby Mode	3 - 16
Discharge Mode.....	3 - 16
View All ECG Mode.....	3 - 17
Changing Lead/Size.....	3 - 17
Touch Screen Calibration	3 - 17
Display Options Troubleshooting	3 - 19
Mechanical Functions.....	4 - 1
Introduction	4 - 2
V 12.....	4 - 2
V 12 Docking	4 - 2
V 12 Undocking.....	4 - 3
Battery Installation	4 - 4
Battery Removal.....	4 - 6
Battery Charge Checking	4 - 8
Module Installation	4 - 9
Module Indicator Lights.....	4 - 10
Module Removal.....	4 - 11
V Dock.....	4 - 12
V Dock Mounting.....	4 - 12
V Dock Dismounting	4 - 15
V 21.....	4 - 16
V 21 Docking	4 - 16
V 21 Undocking	4 - 17
V Hub	4 - 18
V Hub Mounting.....	4 - 18
V Hub Dismounting	4 - 18
Module Installation	4 - 18
Module Removal.....	4 - 19
Module Locking	4 - 20
Module Unlocking.....	4 - 20
V Hub Status Indicators	4 - 21
Connecting the V Hub to the V 12/V 21	4 - 22
Rolling Stand.....	4 - 24
Thermal Recorder	4 - 27
Installing the Thermal Recorder Paper	4 - 27
Mechanical Functions Troubleshooting	4 - 29
Module Configuration	5 - 1
Module Status Dialog.....	5 - 2
Navigating to the Module Status Dialog	5 - 3

Enabling/Disabling a Module.....	5 - 3
Changing an IBP or Temperature Module Channel	5 - 3
Changing VDI Modes	5 - 4
V 12/V 21 V Hub Module Limitations	5 - 4
V 12/V 21 Module Limitations.....	5 - 5
VPS Synchronization	5 - 6
VPS Synchronization: Mismatched Patient IDs.....	5 - 6
VPS Synchronization: Same Patient IDs.....	5 - 6
VPS Synchronization Failures.....	5 - 7
Module Configuration Troubleshooting.....	5 - 8
Patient Management.....	6 - 1
Introduction	6 - 2
Patient Info Dialog	6 - 2
Navigating to the Patient Info Dialog	6 - 2
Admitting a Patient.....	6 - 3
Patient Demographics	6 - 3
Patient Room and Bed.....	6 - 4
Discharging a Patient.....	6 - 5
Clearing Patient History	6 - 6
Placing a Patient in Standby.....	6 - 7
Exiting the Standby Mode.....	6 - 7
Patient Management Troubleshooting.....	6 - 8
Alarm Behavior	7 - 1
General Alarm Behavior.....	7 - 2
Physiological Alarms	7 - 2
Alarm Behaviors	7 - 2
Alarm Options.....	7 - 2
Physiological Alarm Responses.....	7 - 3
Technical Alarms.....	7 - 4
Alarm Behaviors	7 - 4
Alarms	8 - 1
Alarms	8 - 2
Navigating to the Alarms Dialogs.....	8 - 2
Alarm Limits.....	8 - 2
Configuring Alarm Limits.....	8 - 2
Factory Default Alarm Limits.....	8 - 4
Oximetry	8 - 11
Alarm Responses	8 - 13
Understanding Alarm Levels.....	8 - 13
Factory Default Alarm Priorities between Alarm Types.....	8 - 13
Configuring Alarm Levels	8 - 14
Understanding Alarm Response Settings.....	8 - 14
Configuring Alarm Response Settings.....	8 - 14
Factory Default Alarm Settings.....	8 - 15
Arrhythmia Alarms.....	8 - 17
Understanding Alarm Levels.....	8 - 17
Configuring Arrhythmia Alarm Levels	8 - 17
Understanding Arrhythmia Alarm Responses	8 - 19
Configuring the Arrhythmia Alarm Responses	8 - 19
Configuring Arrhythmia Alarm Setup	8 - 20
Alarm Setup.....	8 - 21
Configuring Alarm Setup.....	8 - 21

Alarms Troubleshooting	8 - 22
ECG – Arrhythmia.....	9 - 1
Introduction	9 - 2
ECG Dialog	9 - 3
Navigating to the ECG Dialog	9 - 3
Configuring the Arrhythmia Tab.....	9 - 3
Configuring Pacemakers.....	9 - 4
Configuring ECG Setup.....	9 - 5
Configuring the Arrhy Setup	9 - 7
Relearning	9 - 7
Viewing All ECG Waveforms	9 - 8
Arrhythmia Digital Tile Layout.....	9 - 9
About the Arrhythmia Tile	9 - 9
Arrhythmia Alarms.....	9 - 9
Message Area	9 - 9
ECG Waveform Tile Layout.....	9 - 10
About the ECG Tile	9 - 10
Arrhythmia Alarms.....	9 - 10
Message Area	9 - 10
Preparation and Lead Placement	9 - 12
Skin Preparation.....	9 - 12
Electrode Patch Location	9 - 12
Lead Placement.....	9 - 13
Arrhythmia Algorithm	9 - 23
Noise and Artifact	9 - 23
Heart Rate Meter.....	9 - 24
Filtering Pacer Signals.....	9 - 24
ECG Amplitude	9 - 24
Learning.....	9 - 24
Beat Detection and Typing	9 - 24
Arrhythmia Alarms.....	9 - 25
Lethal Arrhythmia Alarms.....	9 - 25
Non-Lethal Arrhythmia Alarms.....	9 - 26
ST Segment Analysis	9 - 29
Learning.....	9 - 29
ECG Filters	9 - 30
12 Lead Interpretation.....	9 - 31
12 Lead Dialog.....	9 - 31
12 Lead Report	9 - 34
ECG-Arrhythmia Troubleshooting	9 - 35
Respiration (Resp)	10 - 1
Introduction	10 - 2
Resp Dialog	10 - 2
Navigating to the Resp Dialog	10 - 2
Configuring Resp Alarm Limits.....	10 - 3
Configuring the Resp Parameter	10 - 3
Configuring the Resp Waveform	10 - 4
Configuring Apnea Alarms.....	10 - 5
Respiration Tile Layouts.....	10 - 7
Respiration Digital Tile Layout.....	10 - 7
About the Resp Tile.....	10 - 7
Resp Alarms	10 - 7

Message Area	10 - 7
Respiration Waveform Tile Layout	10 - 8
About the Resp Waveform Tile	10 - 8
Respiration Troubleshooting	10 - 9
Invasive Blood Pressure (IBP)	11 - 1
Introduction	11 - 2
IBP Dialog	11 - 3
Navigating to the IBP Dialog	11 - 3
Configuring IBP Alarm Limits	11 - 3
Configuring the IBP Parameter	11 - 3
Configuring the IBP Waveform	11 - 5
Measuring IBP	11 - 7
Measuring ICP	11 - 8
Assembling the Mounting Bracket for Camino Connection Cables	11 - 8
Connecting to the Camino Device	11 - 10
IBP Tile Layouts	11 - 12
IBP Digital Tile Layout	11 - 12
PA Digital Tile	11 - 13
PAWP Digital	11 - 13
Intracranial Pressure (ICP) Digital Tile	11 - 13
Intraabdominal Pressure (IAP) Digital Tile	11 - 13
About the IBP Tile	11 - 14
Message Area	11 - 14
IBP Waveform Tile Layout	11 - 15
Inserting the PA Catheter	11 - 16
Pulmonary Artery Wedge Pressure (PAWP)	11 - 17
Measuring PAWP	11 - 17
Understanding the PAWP Dialog	11 - 18
PAWP Setup Dialog	11 - 18
IBP Troubleshooting	11 - 20
Heart Rate (HR)	12 - 1
Introduction	12 - 2
HR Dialog	12 - 2
Navigating to the HR Dialog	12 - 2
Configuring Heart Rate Alarm Limits	12 - 3
Configuring the Heart Rate Parameter	12 - 3
Heart Rate Digital Tile Layout	12 - 4
About the HR Tile	12 - 4
HR Alarms	12 - 4
Message Area	12 - 5
HR Troubleshooting	12 - 6
Temperature (Temp)	13 - 1
Introduction	13 - 2
Temperature Dialog	13 - 3
Navigating to the Temperature Dialog	13 - 3
Configuring Temperature Alarm Limits	13 - 3
Configuring the Temperature Parameter	13 - 3
Measuring ICT	13 - 5
Assembling the Mounting Bracket for Camino Connection Cables	13 - 5
Connecting to the Camino Device	13 - 7
Measuring Temperature	13 - 9
Temperature Probes	13 - 9

Esophageal Stethoscope with 400 Series Thermistor Temperature Sensor	13 - 10
Esophageal/Rectal Temperature Probe with 400 Series Thermistor	13 - 11
Temperature Digital Tile Layout	13 - 13
About the Temperature Tile	13 - 14
Temperature Alarms.....	13 - 14
Message Area	13 - 14
Temperature Troubleshooting	13 - 15
Non-Invasive Blood Pressure (NIBP)	14 - 1
Introduction	14 - 2
NIBP Dialog	14 - 3
Navigating to the NIBP Dialog.....	14 - 3
Configuring NIBP Alarm Limits.....	14 - 3
Configuring the NIBP Parameter.....	14 - 3
Measuring NIBP	14 - 5
Measurement Types	14 - 5
NIBP Cuff Checklist.....	14 - 5
Measuring NIBP	14 - 6
NIBP Interval Measurements	14 - 6
Pausing/Restarting a Clock or Interval NIBP Measurement	14 - 7
NIBP Stat Measurements	14 - 7
Stopping a Stat NIBP Measurement	14 - 7
General NIBP Information.....	14 - 8
Cuff Inflation Time.....	14 - 8
NIBP Pressure Limit Fail Safe	14 - 8
NIBP Tile Layouts	14 - 9
NIBP Digital Tile Layout	14 - 9
About the NIBP Tile	14 - 9
NIBP Alarms	14 - 9
Heart Rate (HR) Measurement	14 - 9
Message Area	14 - 10
NIBP List Tile Layout	14 - 11
NIBP Troubleshooting.....	14 - 12
Pulse Oximetry (SpO₂)	15 - 1
Introduction	15 - 2
SpO ₂ Dialog.....	15 - 3
Navigating to the SpO ₂ Dialog.....	15 - 3
Configuring SpO ₂ Alarm Limits.....	15 - 3
Configuring the SpO ₂ Parameter Setup	15 - 3
Configuring the SpO ₂ Waveform	15 - 5
Measuring SpO ₂	15 - 7
Taking an SpO ₂ Measurement.....	15 - 7
Nellcor [®] SpO ₂	15 - 8
Masimo SpO ₂	15 - 8
SpO ₂ Tile Layouts	15 - 9
SpO ₂ Digital Tile Layout	15 - 9
About the SpO ₂ Tile	15 - 10
SpO ₂ Alarms.....	15 - 10
Message Area	15 - 10
SpO ₂ Waveform Tile Layout	15 - 12
About the SpO ₂ Waveform Tile.....	15 - 12
Performance Considerations.....	15 - 13
SpO ₂ Troubleshooting	15 - 14

ST.....	16 - 1
Introduction	16 - 2
ST Dialog.....	16 - 2
Navigating to the ST Dialog.....	16 - 2
Configuring ST Alarms Limits.....	16 - 3
Configuring the ST Parameter	16 - 3
Adjusting the ISO and J/ST Points.....	16 - 5
Reviewing ST Points	16 - 7
ST Relearning	16 - 7
ST Tile Layouts.....	16 - 9
ST Digital Tile Layout.....	16 - 9
About the ST Tile.....	16 - 10
Message Area	16 - 10
ST Rep Beat Tile	16 - 11
About the ST Rep Beat Tile.....	16 - 12
ST Alarms	16 - 12
ST Troubleshooting	16 - 13
CO2 Monitoring (Optional)	17 - 1
Introduction	17 - 2
CO2 Dialog.....	17 - 2
Navigating to the CO2 Dialog.....	17 - 2
Configuring CO2 Alarm Limits.....	17 - 3
Configuring the CO2 Parameter Setup.....	17 - 3
Configuring the CO2 Waveform	17 - 4
Calibrating the CO2 Module.....	17 - 6
Taking a CO2 Measurement	17 - 7
CO2 Sensors.....	17 - 8
CO2 Tile Layouts	17 - 9
CO2 Digital Tile Layout	17 - 9
About the CO2 Digital Tile	17 - 9
CO2 Alarms	17 - 9
Message Area	17 - 10
CO2 Waveform Tile Layout	17 - 11
About the CO2 Waveform Tile.....	17 - 11
Message Area	17 - 11
CO2 Troubleshooting	17 - 12
Cardiac Output (CO) (Optional)	18 - 1
Introduction	18 - 2
Cardiac Output Dialog.....	18 - 2
Navigating to the Cardiac Output Dialog.....	18 - 2
Configuring Tblood Alarm Limits	18 - 3
Configuring the CO Parameter	18 - 3
Measuring CO	18 - 6
Optimizing CO Measurements	18 - 6
Auto and Manual CO Measurements.....	18 - 6
Taking CO Measurements	18 - 6
CO Digital Tile Layout	18 - 10
About the CO Tile.....	18 - 10
CO Alarms.....	18 - 10
Message Area.....	18 - 11
CO Troubleshooting.....	18 - 12

Reports	19 - 1
Introduction	19 - 2
Print Setup	19 - 2
Navigating to the Print Setup Dialog	19 - 2
Configuring the Print Setup.....	19 - 3
Configuring the Waveforms to Print	19 - 4
Configuring the Print Destination	19 - 5
Print Queue.....	19 - 7
Navigating to the Print Queue Dialog	19 - 7
Deleting all Print Requests.....	19 - 7
Internal Recorder (Optional).....	19 - 8
Printing to the Thermal Recorder.....	19 - 8
Printing an ECG Strip.....	19 - 8
Laser Printer Reports.....	19 - 9
Waveform Report	19 - 9
12 Lead Report	19 - 11
List Trend Report	19 - 15
Disclosure Overview Report	19 - 17
Disclosure Detail Report.....	19 - 19
Event List Report.....	19 - 22
Event Detail Report.....	19 - 24
Graphic Trend Report.....	19 - 27
Print On Alarm Report.....	19 - 30
ST Report	19 - 32
PAWP Report.....	19 - 35
Drug Calculations Report	19 - 37
Hemodynamic Calculation Report.....	19 - 39
Quick Trend Report.....	19 - 41
System Settings Report	19 - 43
Printing Troubleshooting.....	19 - 46
History Dialogs.....	20 - 1
Introduction	20 - 2
Trends.....	20 - 2
Navigating to the Quick Trends Tab	20 - 2
About Quick Trends.....	20 - 2
List Trends	20 - 2
Navigating to the List Trends Tab.....	20 - 3
About the List Trends Tab	20 - 3
Navigating in the List Trends Tab.....	20 - 3
Configuring a List Trends Display Interval.....	20 - 4
Configuring a List Trends Display Group	20 - 4
Configuring a List Trends Time Search	20 - 4
Printing from the List Trends Tab.....	20 - 4
Graphic Trends	20 - 4
Navigating to the Graphic Trends Tab.....	20 - 4
About the Graphic Trends Tab	20 - 5
Viewing Event Detail from Graphic Trends	20 - 5
Navigating in the Graphic Trends Tab	20 - 6
Configuring a Graphic Trends Display Interval.....	20 - 6
Configuring a Graphic Trends Display Group	20 - 6
Configuring a Graphic Trends Time Search	20 - 6
Printing from Graphic Trends.....	20 - 6

Events Tab.....	20 - 7
Navigating to the Events Tab.....	20 - 7
Events - List View	20 - 7
About the Events - List View Tab	20 - 7
Navigating in the Events - List View.....	20 - 8
Applying/Removing an Events Filter.....	20 - 8
Tagging Events in the Events - List View.....	20 - 9
Archiving Events in the Events - List View	20 - 9
Changing Leads in the Events - List View	20 - 10
Creating an Events - List View Time Search	20 - 10
Deleting Events in the Events - List View	20 - 10
Configuring Displayed Parameters for the Events - List View	20 - 10
Printing from the Events - List View.....	20 - 10
Accessing the Events - Detail View.....	20 - 10
About the Events - Detail View	20 - 11
Navigating in the Events - Detail View.....	20 - 11
Configuring Displayed Parameters for the Events - Detail View	20 - 12
Printing from the Events - Detail View.....	20 - 12
Full Disclosure.....	20 - 13
Navigating to the Full Disclosure - Overview View	20 - 13
About the Full Disclosure - Overview View	20 - 13
Navigating in the Full Disclosure - Overview View.....	20 - 13
Changing Leads in the Full Disclosure - Overview View	20 - 14
Creating a Full Disclosure - Overview View Time Search	20 - 14
Printing from the Full Disclosure - Overview View.....	20 - 14
Accessing the Full Disclosure - Detail View.....	20 - 14
About the Full Disclosure - Detail View	20 - 14
Navigating in the Full Disclosure- Detail View	20 - 14
History Dialog Common Functions	20 - 16
Configuring a Display Interval	20 - 16
Configuring a Display Group.....	20 - 17
Configuring Custom Configuration Option.....	20 - 17
Configuring a Time Search.....	20 - 19
Changing Leads	20 - 20
Adding/Deleting Event Notes.....	20 - 20
Performing ECG Waveform Measurements	20 - 21
Configuring Displayed Parameters.....	20 - 22
Printing from the Historical Dialogs	20 - 22
Historical Events.....	20 - 25
Troubleshooting.....	20 - 30
Calculators.....	21 - 1
Hemodynamics Calculations.....	21 - 2
Hemodynamics Dialog	21 - 2
Navigating to the Calculator Tab.....	21 - 2
Navigating to the Log Tab.....	21 - 5
Hemodynamic Calculations Report.....	21 - 6
Hemodynamic Calculations Troubleshooting	21 - 6
Drug Calculations.....	21 - 7
Drug Calculator Dialog	21 - 7
Navigating to the Drug Calculator Dialog	21 - 7
Configuring a Drug Calculation	21 - 8
Previous Drug Calculations.....	21 - 12

Deleting a Drug from the Previous Calculations List.....	21 - 13
Navigating to the Drug Titration Table	21 - 13
Drug Calculations Report	21 - 15
Drug Calculator Troubleshooting	21 - 15
Alarm Watch	22 - 1
Alarm Watch.....	22 - 2
Navigating to the Alarm Watch Setup Dialog.....	22 - 2
Alarm Watch Bed Status Symbols	22 - 3
Adding a Bed.....	22 - 3
Removing a Bed	22 - 4
Adding Alarms to Watched Alarm List.....	22 - 4
Removing Alarms from the Watched Alarms List.....	22 - 5
Alarm Watch Tile.....	22 - 6
Alarm Watch Notification	22 - 6
Acknowledging Watched Alarms	22 - 7
Alarm Watch Troubleshooting	22 - 8
Remote View	23 - 1
Remote View	23 - 2
Remote View Setup at the Host Monitor	23 - 3
Configuring the Remote View Display Dialog	23 - 3
Managing Alarm Delays from the Host Monitor	23 - 4
Printing from the Remote View Dialog.....	23 - 5
Remote View Troubleshooting.....	23 - 6
VAccess	24 - 1
Introduction	24 - 2
Navigating to the VAccess Dialog	24 - 2
Connecting to a VAccess Location	24 - 2
System Setup	25 - 1
Introduction	25 - 2
System Dialog.....	25 - 2
Navigating to the System Dialog.....	25 - 2
Configuring the General Tab.....	25 - 3
Configuring the Quick Functions Tab.....	25 - 4
Configuring the Alarms Tab	25 - 6
Configuring the Alarm/Response Tab Order.....	25 - 8
Configuring the Printer Tab.....	25 - 9
Configuring the Network Tab	25 - 10
Configuring VAccess	25 - 12
Entering VAccess Addresses.....	25 - 13
Configuring ECG Management Setup	25 - 13
Configuring the Alarm Watch Tab.....	25 - 14
Adding an Alarm Watch Location	25 - 14
Removing an Alarm Watch Location.....	25 - 15
Adding Alarms to a Watched Alarm List	25 - 15
Removing Alarms from the Watch Alarm List.....	25 - 15
Alarm Watch Response.....	25 - 16
Configuring the System Tab.....	25 - 16
Configuration Management.....	25 - 19
Product Maintenance	26 - 1
Introduction	26 - 2
Care and Cleaning of Monitor, Modules and Racks	26 - 2

Monitor Sterilization.....	26 - 2
Care and Cleaning of SpO ₂ Sensors.....	26 - 3
Care and Cleaning of Reusable Temperature Probes	26 - 3
Care and Cleaning of Reusable Cuffs	26 - 4
Reusable Cuffs with Bladders.....	26 - 4
Reusable Bladderless Cuffs	26 - 4
Care and Cleaning of Lead ECG Cables and Wires	26 - 5
Battery Maintenance	26 - 5
Care of CO ₂ Module	26 - 6
Accessories	27 - 1
ECG	27 - 2
ECG Electrodes	27 - 2
ECG Cables	27 - 2
ECG Leadsets	27 - 2
SpO ₂	27 - 4
Masimo SpO ₂ Module	27 - 4
Nellcor® SpO ₂ Module	27 - 5
NIBP	27 - 5
Temperature	27 - 6
Disposable 400 Series Temperature Probes	27 - 6
IBP	27 - 7
CO ₂	27 - 7
Oridion Microstream CO ₂ Module	27 - 7
CO	27 - 8
Miscellaneous Accessories.....	27 - 9
Mounts & Mounting Accessories	27 - 10
Networking Accessories.....	27 - 10
Manuals.....	27 - 10
Product Specifications.....	28 - 1
Specifications	28 - 2
Standards Compliance	28 - 2
V 12 Safety Designations:	28 - 3
V 21 Safety Designations:	28 - 4
V Dock Safety Designations:.....	28 - 5
VPS Safety Designations:	28 - 6
V Hub Safety Designations:.....	28 - 7
12 Lead ECG Safety Designations:.....	28 - 7
CO Module Safety Designations:	28 - 8
CO ₂ Module Safety Designations:.....	28 - 9
IBP Module Safety Designations:	28 - 9
Temp Module Safety Designations:.....	28 - 10
Recorder Safety Designations:.....	28 - 11
VDI Safety Designations:.....	28 - 11
Visual and Auditory Alarm Disclosure.....	28 - 12
Verifying Alarm Functionality	28 - 12
ECG Performance	28 - 13
Impedance Respiration	28 - 25
Non-Invasive Blood Pressure (NIBP)	28 - 28
Invasive Blood Pressure (IBP)	28 - 32
Temperature	28 - 34
Pulse Oximetry (SpO ₂).....	28 - 36
Analog Output.....	28 - 39

Thermodulution Cardiac Output (CO)	28 - 40
Carbon Dioxide (CO2)	28 - 41
Drug Calculations	28 - 44
Patient Contacting Materials	28 - 44
Power Specifications	28 - 45
Performance Characteristics	28 - 46
ECG Specifications	28 - 46
Temperature Performance Characteristics	28 - 47
Recorder Parameter Specifications	28 - 47
Continuous Cardiac Output (CCO) Performance Characteristics	28 - 48
Safety Designations	28 - 49
Safety Classification	28 - 49
Electromagnetic Capability	28 - 50
EMC Safety	28 - 50
V 12/V 21	28 - 50
FCC/IC	28 - 53
Environmental Conditions	28 - 54
Power Supply	28 - 54
Sound	28 - 54
Communication Protocols	28 - 54
Connection to Panorama® Central Station	28 - 54
Operator Position	28 - 54
Glossary	29 - 1
Terms, Acronyms, and Abbreviations	29 - 2

Foreword

CAUTION: U.S. Federal Law restricts this device to sale by or on the order of a physician or other practitioner licensed by U.S. state law to use or order the use of this device.

NOTE: Figures in this manual are provided for reference purposes only. Screens may slightly differ based screen resolution and setup configuration.

Patents: This device is covered under one or more of the following U.S. Patents: RE 38,492; RE 38,476; 7,221,971; 7,215,986; 7,215,984; 6,850,787; 6,826,419; 6,822,564; 6,816,741; 6,745,060; 6,699,194; 6,684,090; 6,654,624; 6,650,917; 6,643,530; 6,606,511; 6,463,311; 6,430,525; 6,360,114; 6,236,872; 6,229,856; 6,067,462; 6,011,986; 6,002,952; 5,919,134; 5,769,785; 5,758,644; 5,685,299; 5,632,272; 5,490,505; 5,482,036; 4,802,486; 4,869,254; 4,928,692; 4,934,372; 4,960,126; 5,078,136; 5,485,847; 5,743,263; 5,865,736; 6,035,223; 6,298,252; 6,463,310; 6,591,123; 6,675,031; 6,708,049; 6,801,797; 7,254,433; 6,428,483; 6,997,880; 5,300,859; 6,437,316; 7,530,955 RE 35,122 foreign equivalents; and Masimo patents (www.masimo.com/patents.htm). Possession or purchase of this device does not convey any express or implied license to use the device with replacement parts which would, alone, or in combination with this device, fall within the scope of one or more of the patents relating to this device.

General knowledge of monitoring and an understanding of the features and functions of the **V 12/V 21** are prerequisites for its proper use.

Please read and adhere to all of the warnings and precautions listed throughout this manual.

A **WARNING** is provided to alert the user to potentially serious outcomes (death, injury or serious adverse events) to the patient or the user.

A **CAUTION** is provided to alert the user that special care should be taken for the safe and effective use of the device. They will include actions to be taken to avoid effects on patients or users that will not be potentially life threatening or result in serious injury, but about which the user should be aware.

A **NOTE** is provided when additional general information is available.

Warnings

- WARNING:** Possible explosion hazard. Do not operate machine near flammable anesthetic agents or other flammable substances. Do not use flammable anesthetic agents (i.e., ether or cyclopropane.)
- WARNING:** If liquid is accidentally spilled on equipment, battery, or accessories, or they have been immersed in liquid, contact service personnel. Do not operate the equipment before it has been tested and approved for further use.
- WARNING:** Do not connect other equipment to the same MPSO (Multiple Portable Socket Outlets i.e. Multiple outlet extension cords) with the V 12/V 21, as it may increase system leakage current. Only use the MPSO to supply power to the equipment.
- WARNING:** Devices connected to the equipment must meet the requirements of the applicable IEC standards (e.g. IEC 60950 safety standards for information technology equipment and IEC 60601-1 safety standards for medical electrical equipment). The system configuration must meet the requirements of the IEC 60601-1-1 medical electrical systems standard. Any personnel who connect devices to the equipment's signal input/output port is responsible for providing evidence that the safety certification of the devices has been performed in accordance to the IEC 60601-1-1. If you have any questions, please contact Mindray.
- WARNING:** Use of the V 12/V 21 in the vicinity of explosive anesthetics and in the presence of electromagnetic interference or power overloads caused by electrosurgical or diathermy instruments could create a potential hazard or could damage the monitor.
- WARNING:** Fire, explosion or severe burn hazard. Do not disassemble, crush, heat above 100°C (212°F), or incinerate. Replace only with the Mindray DS USA, Inc. P/N 0146-00-0091-01. See operator's manual for safety instructions. Battery is not fully charged upon delivery. Please charge battery before initial use.
- WARNING:** This device is NOT suitable for use in a magnetic resonance imaging (MRI) environment.
- WARNING:** This device is not intended for direct cardiac application.
- WARNING:** Use of the V 12/V 21 is restricted to one patient at a time.
- WARNING:** Electrode polarization: some electrodes may be subject to large offset potentials due to polarization. Use only electrodes as recommended by Mindray. Recovery time after application of defibrillator pulses may be especially compromised. Squeeze bulb electrodes commonly used for diagnostic ECG recording may be particularly vulnerable to this effect. Electrodes of dissimilar metals should not be used unless the amplifier can handle polarization potentials as high as 1 volt (V).
- WARNING:** To reduce the hazard of burns in the high-frequency surgical neutral electrode connection, the electrodes should not be located between the surgical site and the electro-surgical unit return electrode.
- WARNING:** Patients with fragile skin, dermal allergies, or a history of skin reactions to adhesive tapes may show a dermatitis type reaction to ECG electrodes and SpO₂ sensors.

-
- WARNING:** Reliably attach Potential Equalization connector to the safety ground when interconnecting V 12/V 21 with other medical or non-medical electrical equipment to minimize the risk of excessive leakage current and/or shock hazard.
- WARNING:** This unit uses a common isolation path for the ECG leads and the Invasive Pressure Channels. Ensure that conductive parts of the ECG electrodes do not contact other conductive parts including earth ground. Do not connect any non-isolated accessories to the unit or to the ECG or invasive pressure channel inputs when connected to a patient. Insure that the total chassis leakage currents of all connected units does not exceed 100 μ A in normal conditions and does not exceed 300 μ A in a single fault condition. Use an IEC 60601-1 approved isolation / separation transformer if required. Do not operate the equipment with any cover removed. Do not simultaneously touch the patient and any piece of electrical equipment if any cover has been removed from the equipment.
- WARNING:** When using the 12 lead ECG device cable, the device is not protected against Electro Surgical Unit (ESU) interference.
- WARNING:** Observe extreme caution when a defibrillator is used on a patient. Do not touch any part of patient, table, or monitor when a defibrillator is in use.
- WARNING:** Do not use the V 12/V 21 when it is adjacent to or stacked with other equipment. If adjacent or stacked use is necessary, the V 12/V 21 should be observed to verify normal operation in the configuration in which they will be used.
- WARNING:** Use of accessories, transducers and cables other than those specified in the manual may result in increased Electromagnetic Emissions or decreased Electromagnetic Immunity of the V 12/V 21. It can also cause delayed recovery after the discharge of a cardiac defibrillator.
- WARNING:** Do not put MPSO (Multiple Portable Socket Outlets i.e. Multiple outlet extension cords) used with the V 12/V 21 or its accessories on the floor. Connect only V 12/V 21 accessories to the same MPSO as the V 12/V 21. Do not overload the MPSO. Trace Gas Hazard - When using the optional CO₂ Module, a health hazard exists when trace amounts of vaporized anesthetic agents are chronically inspired by operating room personnel. See Appendix A in NFPA 56A on Inhalation Anesthetics. During any procedure where such agents are employed, the CO₂ Module exhaust output should be connected to a medical gas-scavenging system.
- WARNING:** For safe installation, mount Mindray V Series patient monitoring equipment only to wall mounts identified with the Mindray V Series logo.
- WARNING:** Do not use a damaged or broken unit or accessory.
- WARNING:** Do not use unit if enclosure is damaged.
- WARNING:** Do not reuse disposable accessories. Dispose of single use items in accordance with hospital policy.
- WARNING:** CO₂ FilterLines® should be treated as biohazardous waste and disposed of in accordance with local regulations for contaminated and biologically hazardous items.

-
- WARNING:** When using a sampling line for intubated patients with close suction system, do not place the airway adapter between the suction catheter and endotracheal tube. This is to ensure that the airway adapter does not interfere with the functioning of the suction of the catheter.
- WARNING:** Do not cut or remove any part of the sample line. Cutting the sample line could lead to erroneous readings.
- WARNING:** Loose or damaged connections may compromise ventilation or cause an inaccurate measurement of respiratory gases. Securely connect all components and check connections for leaks according to standard clinical procedures.
- WARNING:** SpO₂ sensors, SpO₂ accessories, and temperature probes should be disposed of in accordance with local regulations.
- WARNING:** To prevent possible electric shock, connect the V 12/V 21 system to a correctly grounded mains connection.
- WARNING:** Pacemaker patients' rate meters may continue to count the pacemaker rate during occurrences of cardiac arrest or some arrhythmias. Do not rely entirely upon rate meter alarms. Keep pacemaker patients under close surveillance. See the Product Specifications chapter of this manual for disclosure of the pacemaker pulse rejection capability of this instrument.
- WARNING:** Due to physiologic differences in the patient population, the V 12/V 21 may occasionally not alarm or may sound a false alarm for some arrhythmia patterns. The arrhythmia analysis feature is intended to detect ventricular rhythms only. High-risk patients should be kept under close surveillance.
- WARNING:** During procedures employing electro-cautery, use currently acceptable procedures to minimize conditions of the thermistor and lead wires functioning as an alternate path for radio-frequency current to return to ground, causing localized tissue burns. Procedures which may minimize risk of electro-surgical burns are: keep both active and ground electrodes of the electro-cautery system in close proximity so that the temperature sensor is outside the radio-frequency current field. Keep temperature monitor with its associated cables separated from electro-cautery systems. Unusual, fast artificial variations in temperature readings may occur with concomitant applications of the electro-cautery system.
- WARNING:** Temperature probes are sterile unless unit container is opened or damaged.
- WARNING:** A hazard can exist if different alarm presets are used for the same or similar equipment in any single area.
- WARNING:** The clinician should check that the current alarm settings on the V 12/V 21 monitor are appropriate prior to use on each patient.
- WARNING:** Setting alarm limits to extreme values can render the alarm system useless.

- WARNING:** In certain situations in which perfusion and signal strength are low, such as in patients with thick or pigmented skin, inaccurately low SpO₂ readings will result. Verification of oxygenation should be made, especially in pre-term infants and patients with chronic lung disease, before instituting any therapy or intervention.
- WARNING:** Many patients suffer from poor peripheral perfusion due to hypothermia, hypovolemia, severe vasoconstriction, reduced cardiac output, etc. These symptoms may cause a loss in vital sign readings.
- WARNING:** Inaccurate SpO₂ measurements may be caused by excessive patient movement.

Cautions

- CAUTION:** Do not operate the unit with the ventilation or speaker vents obstructed.
- CAUTION:** Do not carry the V 12/V 21 using the integrated grip handle if the unit is mounted to another item (e.g., a rolling stand or wall mount).
- CAUTION:** The V 12 rolling stand is intended for use on horizontal surfaces ONLY.
- CAUTION:** The V 21 is intended for mounting only.
- CAUTION:** The V 12 only: A VPS should not be installed into a V Hub connected to a V Dock.
- CAUTION:** The V 12 is designed for use with specific batteries. To avoid possible damage to the system, use approved batteries only.
- CAUTION:** Do not touch the internal parts of the recorder because they may be hot.
- CAUTION:** The SB and MR ports are intended for use with specific Mindray accessories only. To avoid possible damage to the V 12/V 21, use approved ECG cables and accessories only.
- CAUTION:** The V 12/V 21 monitor system has been validated for use with the approved accessories listed in "Accessories" on page 27-1. Use of other accessories not approved for use with the V 12/V 21 monitor may cause unexpected changes in performance or possible damage to the system.
- CAUTION:** The monitor and its components should be serviced by trained and qualified personnel only. Service is defined as any activity requiring internal adjustments, parts replacements, repairs, or software upgrades.
- CAUTION:** Route cables and hoses neatly. Ensure cables, hoses and wires are kept away from patient's neck to avoid strangulation. Keep floors and walkways free of cables to reduce risk to hospital personnel, patients and visitors.
- CAUTION:** To avoid damage to the device or possible personnel injury, the 21" monitor must be reliably mounted using an approved mounting system.
- CAUTION:** Do not block the speakers. Set the volume levels so that alarms can be heard at all times, as described in this Operating Instructions.
- CAUTION:** Do not block or affix anything to the display to avoid obstruction.
- CAUTION:** Do not use damaged cable connectors.
- CAUTION:** Use the power cord provided with the product. If a substitute is necessary, use only hospital grade power cords.
- CAUTION:** To avoid possible device overheating, do not block ventilation or device vents.
- CAUTION:** A blood pressure measurement can be affected by the position of the patient, and his / her physiological condition as well as other factors, such as patient movement.

- CAUTION:** The V 12/V 21 may not meet its performance specifications if stored or operated outside of specified temperature and humidity ranges. If abnormal performance is observed, additional measures may be necessary, such as reorienting or relocating the V 12/V 21.
- CAUTION:** Observe caution on all patients (Neonates, Pediatrics, and Adults) when NIBP is set to the Stat mode and when using the 1 minute interval. When the NIBP Stat is selected, the V 12/V 21 continually takes continuous blood pressure readings. As a safety precaution, a limit is placed on NIBP Stat mode. In NIBP Stat mode, after 5 minutes or 10 readings, the NIBP reverts to the previous interval setting. As a safety precaution in 1 minute mode, a mandatory 30 second deflation period between measurements is added. Reports have been made of nerve injury occurring during use of automatically cycled blood pressure cuffs.
- CAUTION:** To monitor and trend NIBP measurements, the NIBP tile or NIBP list tile must be configured to display. No NIBP monitoring occurs unless one of these tiles are configured to display.
- CAUTION:** When equipped with Nellcor® SpO₂, use only Nellcor oxygen transducers including Nellcor Oxisensor® and OxiMax® patient dedicated adhesive sensors. Use of other oxygen transducers may cause improper oximeter performance.
- CAUTION:** When equipped with Masimo SET® SpO₂, use only Masimo SET Oxygen Transducers including Masimo SET LNOP® and LNCS® Patient Dedicated Adhesive Sensors and Masimo SET PC Series Patient Cables. Use of other oxygen transducers may cause improper oximeter performance.
- CAUTION:** Replace Li-Ion batteries with P/N 0146-00-0091-01 ONLY.
- CAUTION:** Some pacemakers may contain a respiratory sensor that may produce artifact on an ECG waveform.
- CAUTION:** Tissue damage or inaccurate measurements may be caused by incorrect SpO₂ sensor application or use, such as wrapping too tightly, applying supplemental tape, failing to inspect the sensor site periodically, or failing to position appropriately. Carefully read the sensor directions for use, the V 12/V 21 Operating Instructions, and all precautionary information before use.
- CAUTION:** Inaccurate SpO₂ measurements may be caused by:
- Incorrect sensor application or use
 - Significant levels of dysfunctional hemoglobins, (e.g., carboxyhemoglobin or methemoglobin)
 - Intra-vascular dyes such as indocyanine green or methylene blue
 - Exposure to excessive illumination such as surgical lamps (especially ones with a xenon light source), bilirubin lamps, fluorescent lights, infrared heating lamps, or excessive ambient light. In such cases, cover the sensor site with opaque material
 - Venous pulsations
 - Electro-surgical interference
 - Placement of a sensor on an extremity that has a blood pressure cuff, arterial catheter, or intra-vascular line
 - Nail polish or fungus

- CAUTION:** Prolonged and continuous monitoring may increase the risk of skin erosion and pressure necrosis at the site of the sensor. Check the SpO₂ sensor site frequently to ensure proper positioning, alignment and skin integrity at least every eight (8) hours; with the Adult and Pediatric reusable finger sensor, check every four (4) hours; for neonates and patients of poor perfusion or with skin sensitive to light, check every 2 - 3 hours; more frequent examinations may be required for different patients. Change the sensor site if signs of circulatory compromise occur.
- CAUTION:** When cleaning SpO₂ sensors, do not use excessive amounts of liquid. Wipe the sensor surface with a soft cloth, dampened with cleaning solution. Do not attempt to sterilize.
- CAUTION:** A functional tester cannot be used to assess the accuracy of the pulse oximeter probe or a pulse oximeter monitor.
- CAUTION:** Temperature probes are for single use only. Destroy after single use. Do not re-sterilize.
- CAUTION:** Federal (U.S.A.) law restricts this device to be sold by or on the order of a physician.
- CAUTION:** Line Isolation Monitor transients may resemble actual cardiac waveforms, thus inhibiting heart rate alarms. Check lead wires for damage and ensure good skin contact prior to and during use. Always use fresh electrodes and follow proper skin preparation techniques.
- CAUTION:** The V12/V21 monitor does not auto select the ECG lead set used. When the patient's ECG cable is changed, it is essential to manually select the appropriate lead set combination on the monitor. If this is not done, other functions such as ST analysis, ECG Respiration, arrhythmia analysis, ECG analog output, and Defib synchronization could be affected. The following should always be performed after the ECG lead set is changed:
- Manually select the appropriate lead set at the bedside monitor via the user interface.
 - Relearn ST and Arrhythmia analysis.
- CAUTION:** An error message(s) may occur when the bedside monitor's manually selected lead set and the attached lead set do not match.
- CAUTION:** When connecting a sampling line to the monitor, screw the sampling line connector clockwise into the monitor CO₂ port until it can no longer be turned to ensure that it is connected securely to the monitor. This will assure that there is no leak of gases during measurement at the connection point and that measurement accuracy is not compromised.
- CAUTION:** If too much moisture enters the sampling line (i.e., from ambient humidity or breathing of unusually humid air), the message "Clearing FilterLine" appears in the message area. If the sampling line cannot be cleared, the message "FilterLine Blockage" appears in the message area. Replace the sampling line once the "FilterLine Blockage" message appears.
- CAUTION:** Microstream[®] etCO₂ sampling lines are designed for single patient use, and are not to be reprocessed. Do not attempt to clean, disinfect, sterilize or flush any part of the sampling line as this can cause damage to the monitor.

- CAUTION:** Before use, carefully read the Microstream[®] etCO₂ sampling lines Directions for Use.
- CAUTION:** Only use Microstream[®] etCO₂ sampling lines to ensure the monitor functions properly.
- CAUTION:** The VDI module enables the V 12/V 21 to display and store data received from another specialized medical device. The V 12/V 21 can be set to provide alarms on received data, but the connected medical device should be regarded as the primary monitor for the parameter it is monitoring. For patient safety, do not turn off the alarm systems of connected devices.
- CAUTION:** The VDI serial port connector is exclusively for connection to equipment. If the serial port connector contacts the patient while the VDI module is in an operational system, it can violate requirements of 60601-1-1.
Always keep both ends of a serial cable connected to the VDI module and the associated equipment while the VDI module is plugged into an operational system and keep the VDI module out of patient contact. It may be most convenient to use the VDI module configured in a stationary external module rack.
- CAUTION:** When powering off the unit, do not continue to hold the power button down after the triple-beep signal is heard. Holding the power button down for more than three (3) seconds initiates a hard shutdown of the monitor which may cause unexpected and potentially harmful effects to the monitor database.
- CAUTION:** The AC receptacle (or mains plug) is used to disconnect the medical device. Do not position the device so that it is difficult to operate or access the AC receptacle. Refer to "Back View" on page 1-11 to see where the AC receptacle is located on the device.

Notes

- NOTE:** The comparison testing conducted via the auscultatory method used both Phase 4 and Phase 5 Korotkoff sounds. Reports of study findings for both the auscultatory method as well as the intra-arterial methods are available by contacting Technical Support (800) 288-2121, ext. 8116 or (201) 995-8237.
- NOTE:** If the supply mains has been interrupted during SpO₂ monitoring, the V 12 switches power to battery backup if at least one battery has been installed and charged. If power has been completely interrupted, SpO₂ monitoring continues when the supply mains is restored or a fully charged battery is installed, and power has been recycled to the monitor.
- NOTE:** Pressure transducers are protected against the effects of defibrillation and electro-cautery.
- NOTE:** A VPS is required to monitor any patient parameters.

Indications for Use

The V Series Monitoring System is intended for intra hospital use under the direct supervision of a licensed healthcare practitioner. The Indications for Use for the **V 12/V 21** include the monitoring of the following human physiological parameters:

- ECG waveform derived from 3, 5, 6 and 12 lead measurements
- Heart Rate
- Pulse Oximetry (SpO₂)
- ST Segment Analysis
- Arrhythmia Detection
- Non Invasive Blood Pressure (NIBP)
- Invasive Blood Pressure (IBP)
- Cardiac Output (CO)
- Respiratory Gases
- Respiration Rate
- Temperature

The **V 12/V 21** Monitor has the capability of performing IV Drug and Hemodynamic Calculations and interfacing with network devices.

The target populations are adult, pediatric and neonate with the exception of:

- Arrhythmia detection and ST Segment Analysis, for which the target populations are adult and pediatric only,
- IV Drug Calculations for which the target population is adult only, and
- Cardiac Output for which the target population is adult and pediatric only.

Unpacking Information

Remove the instrument from the shipping carton and examine it for signs of shipping damage. Save all packing materials, invoice and bill of lading. These may be required to process a claim with the carrier. Check all materials against the packing list.

Contact your agents or the Service Department at:

- (800) 288-2121 or (201) 995-8000 (U.S.A and Canada)
- (201) 265-8800 (South America and other areas in North America excluding U.S.A and Canada)
- (86) 755 26582492 or (86) 26582888 (areas other than North and South Americas) for prompt assistance in resolving any shipping issues.

Warranty Statements

Mindray warrants that components within the monitor unit will be free from defects in workmanship and materials for the number of years shown on the sales order. Under this warranty, Mindray will repair or replace any defective component at no charge for labor and/or materials. This warranty does not cover consumable items such as, but not limited to batteries, displays, external cables and sensors.

Recommended preventative maintenance, as prescribed in the Service Manual, is the responsibility of the user, and is not covered by this warranty.

Except as otherwise provided herein, the terms, conditions and limitations of Mindray's standard warranty will remain in effect.

Mindray warrants that its products will be free from defects in workmanship and materials. This warranty does not cover consumable items such as, but not limited to, batteries, external cables, sensors, cuffs, hoses, or mounts.

Mindray will not be liable for any incidental, special, or consequential loss, damage, or expense directly or indirectly arising from the use of its products, liability under this warranty and the buyer's exclusive remedy under this warranty is limited to servicing or replacing at Mindray's option at the factory or at an authorized Distributor, any product which shall under normal use and service appear to the Company to have been defective in material or workmanship.

No agent, employee, or representative of Mindray has any authority to bind Mindray to any affirmation, representation, or warranty concerning its products, and any affirmation, representation or warranty made by any agent, employee, or representative shall not be enforceable by buyer.

This warranty is expressly in lieu of any other express or implied warranties, including any implied warranty or merchantability or fitness, and of any other obligation on the part of the seller.

Damage to any product or parts through misuse, neglect, accident, or by affixing any nonstandard accessory attachments or by any customer modification voids this warranty. Mindray makes no warranty whatever in regard to trade accessories, such being subject to the warranty of their respective manufacturers.

A condition of this warranty is that this equipment or any accessories which are claimed to be defective be returned when authorized, freight prepaid to Mindray DS USA, Inc., Mahwah, New Jersey 07430, Mindray's agents or Mindray service centers in your region. Mindray shall not have any responsibility in the event of loss or damage in transit.

Calibration may be performed without the need to disassemble the instrument. It is the responsibility of the purchaser to perform calibration as necessary, in accordance with the instructions provided in this manual.

Service

Mindray maintains a network of service representatives and factory-trained distributors. Prior to requesting service, perform a complete operational check of the instrument to verify proper control settings. If operational problems continue to exist,

- In North and South Americas contact the Service Department at (800) 288-2121, ext: 8116 for Technical Support or (201) 995-8000 for assistance in determining the nearest field service location.
- In areas other than North and South Americas, contact your agent or Mindray service center in your region. If Mindray service center is not available in your region, please contact the Customer Service of Mindray Shenzhen headquarters at (86) 755 26582492 or (86) 26582888 for technical support or assistance.

Please include the instrument model number, the serial number, and a description of the problem with all requests for service.

Any questions regarding the warranty should be directed to your agent or the nearest Mindray location. A list of international offices, along with their phone numbers, is provided at the end of this manual.



























NOTE: **Upon request, Mindray provides circuit diagrams, component part lists, descriptions, calibration instructions, or other information which assist the user's appropriately qualified technical personnel to repair those parts of the equipment which are designated by Mindray DS USA, Inc. as repairable.**



Manufacturer's Responsibility

Mindray is responsible for the effects on safety, reliability and performance of the equipment only if:

- a. assembly operations, extensions, readjustments, modifications or repairs are carried out by persons authorized by Mindray; and
- b. the electrical installation of the relevant room complies with the appropriate requirements; and
- c. the equipment is used in accordance with the instructions for use.

Symbols and Descriptions

SYMBOL	DESCRIPTION	SYMBOL	DESCRIPTION
	Attention, Consult Accompanying Documents / Refer to Manual		Zero all IBP
	Equipotentiality		Type BF Equipment
	Alternating Current (AC)		Defibrillator Proof Type BF Equipment
	Power On/Off		Defibrillator Proof Type CF Equipment
	Data Output		Alarm Off Icon
	Data Input/Output		Alarm Silence Icon
	Gas Port Input		Alarm Silence Permanently Icon
	Gas Port Output		Separate treatment from general waste at end of life
	Chart Recorder Output		Locked
	NIBP Connection		Unlocked
	Battery Charging		Interference may occur in the vicinity of equipment marked with this symbol
IPX1	Protection against fluid ingress		Manufacturer's reference/catalogue number
	Manufacturer		European Representative Mindray Medical Netherlands B.V. Drs. W. van Royenstraat 8 P.O. Box 26, 3870 CA Hoevelaken The Netherlands
	Start button		Serial number

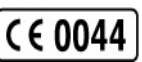
SYMBOL	DESCRIPTION	SYMBOL	DESCRIPTION
 <p>ETL CLASSIFIED C  US Intertek 3191955</p>	<p>CONFORMS TO UL STD 60601-1, IEC 60601-2-27, IEC 60601-2-25, IEC 60601-2-34, IEC 60601-2-30, IEC 60601-2-49</p> <p>CERTIFIED TO CSA STD C22.2 NO 601.1, NO 60601-2-27, NO 60601-2-30, NO 60601-2-34, NO 60601-2-49</p>		<p>Conformité Européenne (CE) Marking of Conformity to European Medical Device Directive. CE_{xxxx} represents the Notified Body number</p>
	<p>A symbol designating compliance of the V 12/V 21 system with the Medical Device Directive (MDD) 93/42/EEC, as a Class IIb device.</p>		

This page intentionally left blank.

General Product Description

General Product Description	1-2
Key Features	1-3
V 12/V 21 Physical Views	1-5
V Dock Physical Views	1-11

1.1 General Product Description

1.1.1 V Series Monitoring Platform

The **V 12/V 21** monitoring platform is a modular patient monitoring system. The system architecture allows users to customize, by removal or addition of modules, monitored parameters based on a patient's monitoring need or acuity level. The modular design simplifies the addition of monitoring additional parameters with the addition of parameter modules.

The **V 12/V 21** monitoring platform focuses on the philosophy of "Ease of Use" while incorporating traditionally highly complex monitoring parameters. The user interface minimizes menu layers and excessive user interaction to simplify patient care. The V Series monitoring platform maximizes the amount of viewable data through the use of a Portrait display orientation.

The **V 12/V 21** monitoring platform consists of the following major components:

1. **V 12/V 21** Monitor - The **V 12/V 21** monitor which includes the system processor, display, user interface and appropriate connectors for communication to peripheral devices. Power the **V 12/V 21** from AC through the V Dock. Up to three (3) removable batteries may also be used to power the **V 12**.
2. V Dock - The **V 12/V 21** V Dock is a physical mount for the **V 12/V 21** designed to provide quick connection and release with peripheral devices. The V Dock incorporates multiple connectivity ports designed to enable quick connection and release for mobility.
3. V Patient Server (VPS) - The **V 12/V 21** VPS is a lightweight parameter acquisition device designed to acquire and store up to 12 hours of real-time vital sign data including 3/5/6 Lead ECG including ST and Arrhythmia Analysis, Respiration, two (2) Invasive Blood Pressures, Non-invasive Blood Pressure, Pulse Oximetry, and Temperature. This module is a patient centered solution that measures the parameter stated and allows it to be moved with the patient between **V 12/V 21** display and control units without removing the patient connections.
4. V Hub - The **V 12/V 21** V Hub hosts several module bays to allow multiple modules to be connected to the monitor. The V Hub connects to the monitor via a PUSB cable.
5. 12 Lead ECG - The **V 12/V 21** 12 Lead ECG module monitors 12 lead ECG and Respiration including ST, Arrhythmia Analysis and 12 Lead Interpretation through the VPS module. 12 Lead Interpretation is obtained using the University of Glasgow 12-Lead ECG algorithm. The **V 12/V 21** 12 Lead ECG is used in conjunction with the VPS by using its ECG port as a connection to the system.
6. CO Module - The **V 12/V 21** CO module acquires thermodulution cardiac output parameter data from the patient.
7. CO₂ Module - The **V 12/V 21** CO₂ module acquires carbon dioxide respiration parameter data from the patient.
8. Battery - The battery is a lithium smart battery and is used in the **V 12** monitor where the V Dock is not available. When powered on, the self-check feature of the **V 12** provides verification of proper operation.
9. IBP Module - The IBP module provides two additional IBP channels.
10. Temperature Module - The Temperature module provides an additional temperature channel.
11. VDI Module - The V Device Integrator module provides the device integration interface.

1.1.2 Interfacing

The **V 12/V 21** has the capability of interfacing with Panorama Central Stations and Nurse Call Systems.

1.2 Key Features

FEATURES	STANDARD	OPTIONAL
Display	- 12.1 inch color touchscreen with up to 8 waveforms - 21.3 inch color touchscreen with up to 12 waveforms	
Portable VPS	3/5/6 lead ECG Respiration SpO ₂ NIBP with Stat Temperature IBP (2 channels) 2 Analog output/defib sync connectors	Additional IBP and Temperature modules are available
ECG	3,5,6 lead (I, II, III, aVR, aVL, aVF, V) ST Analysis	
Arrhythmia Analysis	Asystole Ventricular Tachycardia (V-Tach) Ventricular Fibrillation (V-Fib) Bradycardia R-On-T PVC Pause Pauses/Minute Bigeminy PVCs/Minute Couplet Irregular HR Multiform PVC Run Trigeminy Ventricular Rhythm	
12 Lead	(I, II, III, aVR, aVL, aVF, V-6)	Requires a VPS and a 12 Lead ECG Module
Non-Invasive Blood Pressure (NIBP)	VPS contains one NIBP connector	
SpO ₂	VPS contains one SpO ₂ connector	Nellcor® SpO ₂ , MasimoSET® SpO ₂
Temperature	VPS contains one probe connector	Up to two (2) Temp modules may be installed
Respirations	Lead-selectable impedance	
Invasive Blood Pressure (IBP)	VPS contains two IBP connectors	Up to three (3) dual IBP modules may be installed
CO	Thermodulution CO/CI/Tblood	
CO ₂	MicroStream®	
Pulmonary Artery Wedge Pressure (PAWP)	Uses reference line.	
History	12 hours full disclosure in VPS Module 48 hours full disclosure in V 12/V 21 Monitors	
Power	V Dock/AC Power	Li-Ion battery Battery applicable to the V 12 monitor only
Printing		Internal recorder, Laser Printer

FEATURES	STANDARD	OPTIONAL
External Interfaces	Ethernet network	Connectivity to Panorama Central Station and Laser Printer
Calculations	IV drug calculations and hemodynamic calculations	
Other	Soft Grip Handle - Applicable to V 12 only	Arm Mounts Rolling stand - Applicable to V 12 only

1.3 V 12/V 21 Physical Views

1.3.1 Front View

The front view contains:

1. Alarm lights/indicators
2. Display
3. Touch Pad

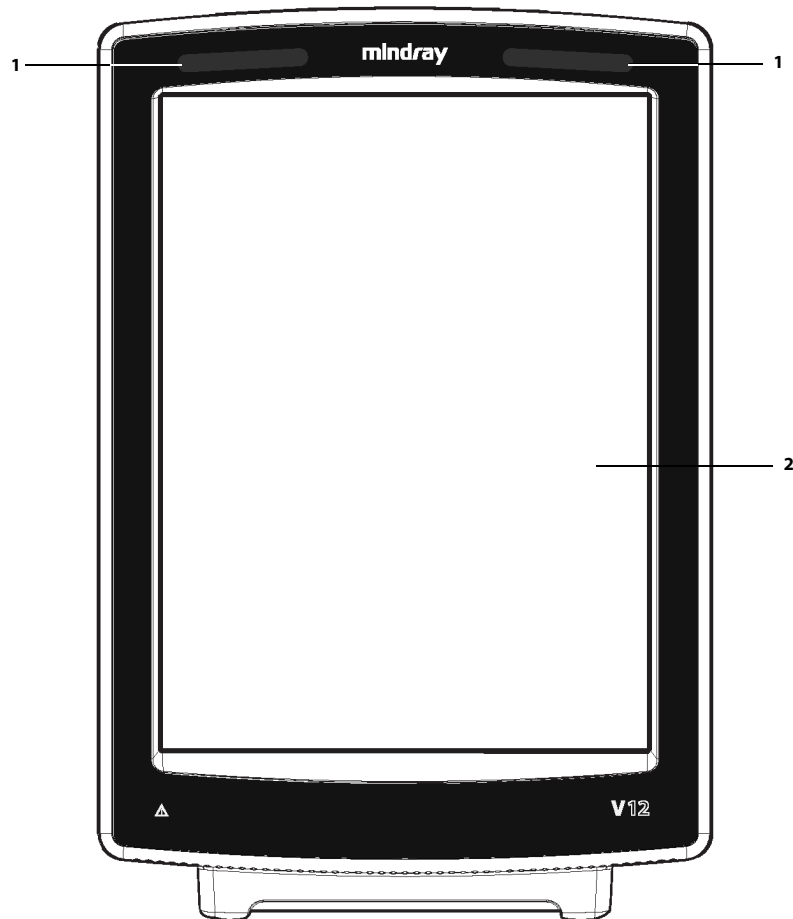

FIGURE 1-1 Example V 12 Front Panel

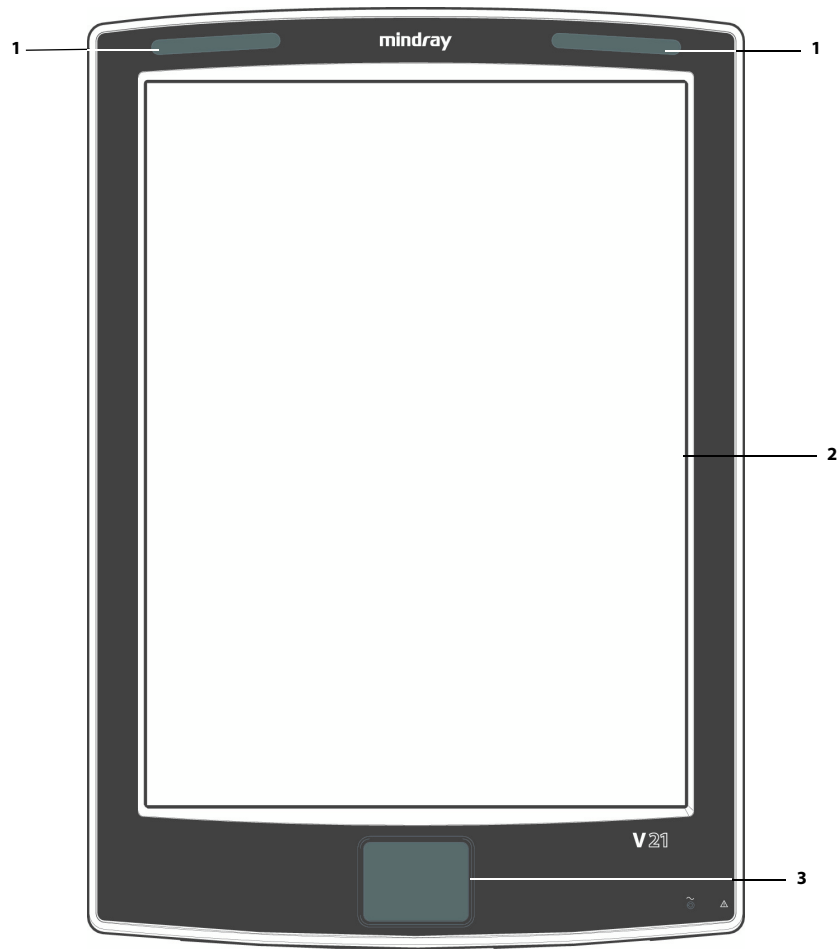

FIGURE 1-2 Example V 21 Front Panel

1.3.2 Rear View

1. Handle
2. Integrated module bays
3. Grips/actuators
4. VDock connector

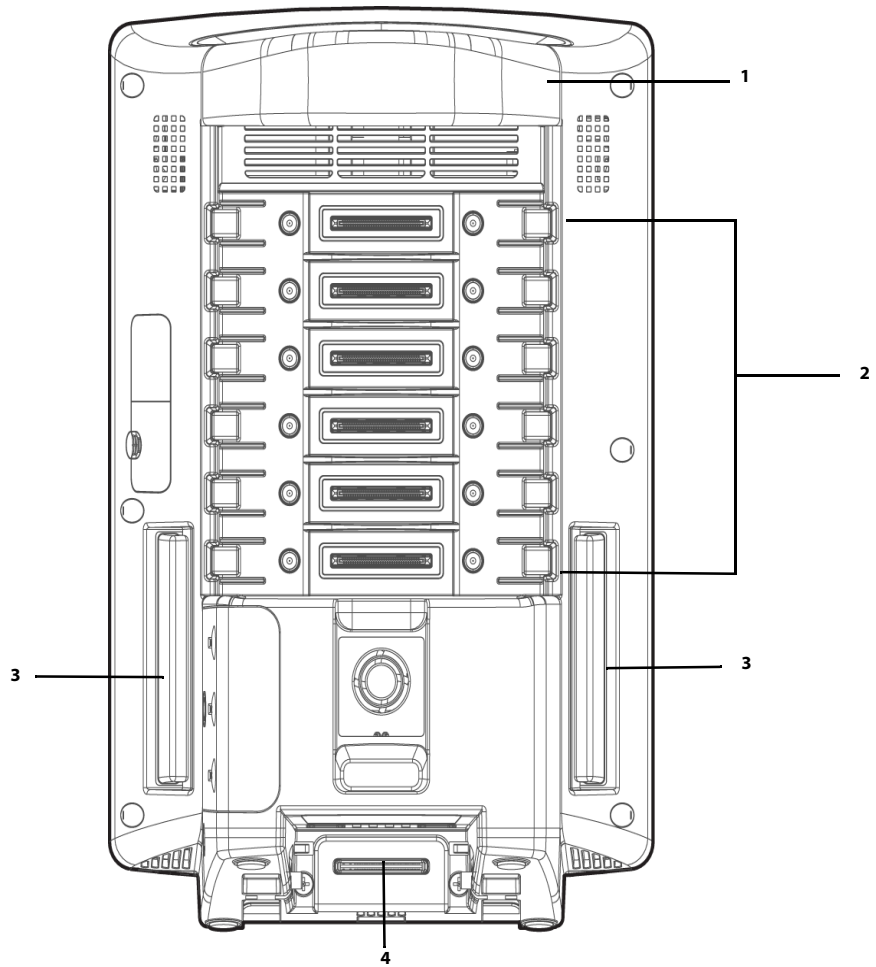

FIGURE 1-3 Example V 12 Rear Panel

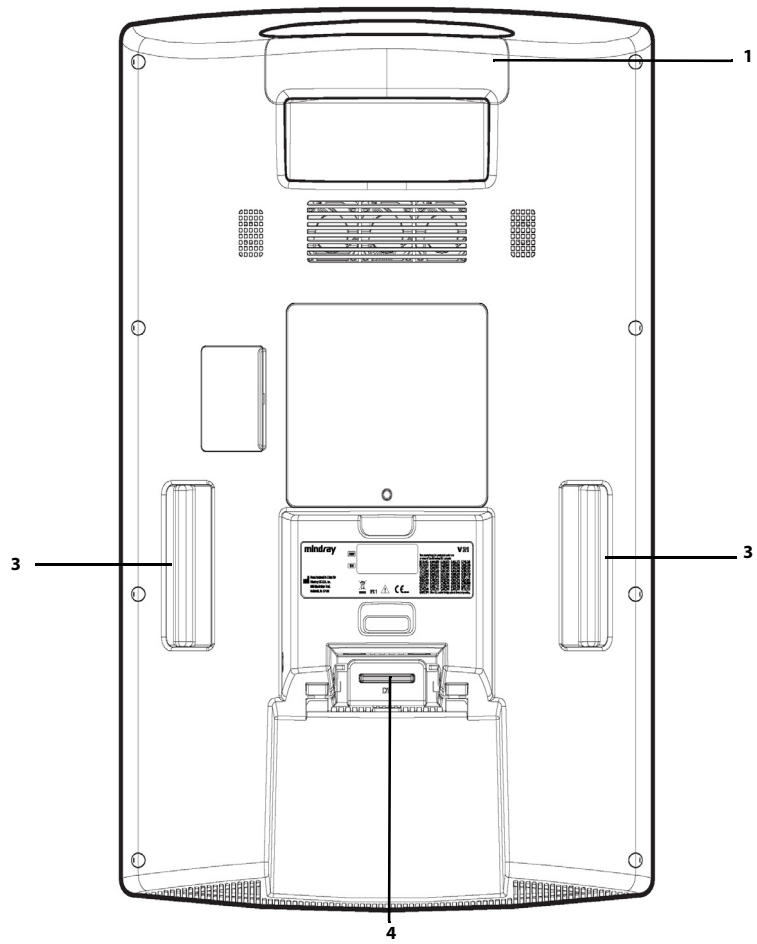

FIGURE 1-4 Example V 21 Rear Panel

1.3.3 Left Side Panel

1. Handle
2. Side grip/actuator

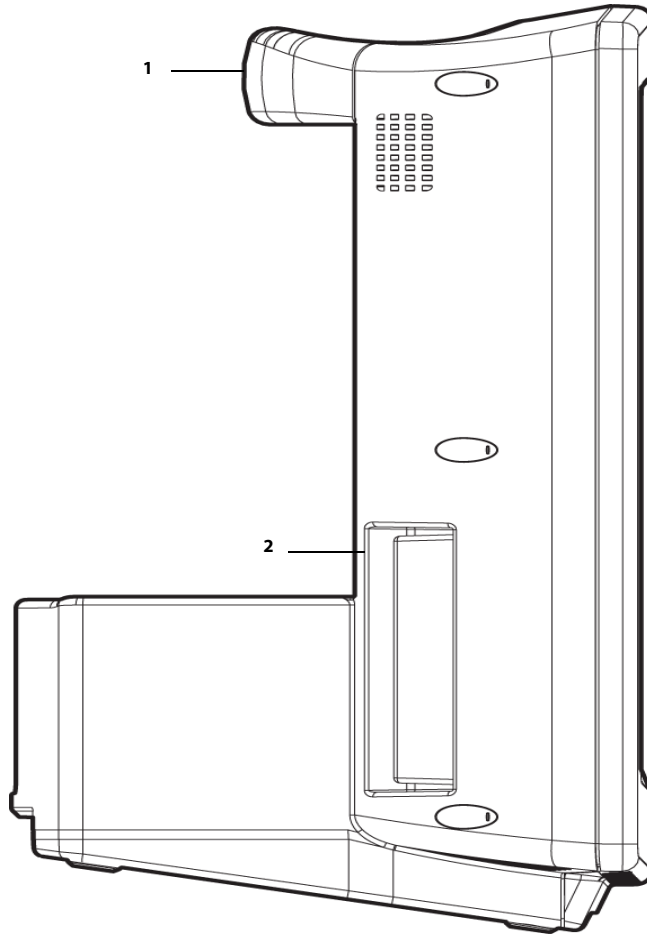

FIGURE 1-5 Example V 12 Left Side Panel

1.3.4 Right Side Panel

1. Handle
2. Diagnostics port
3. MR 1 connectors
4. Side grip/actuator
5. Battery compartment
6. Power button

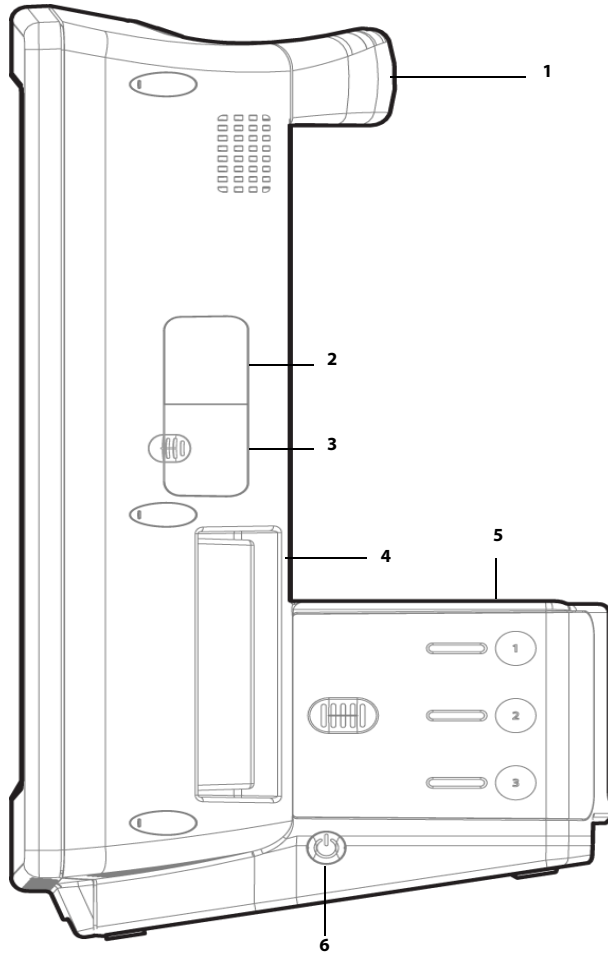

FIGURE 1-6 Example V 12 Right Side Panel

1.4 V Dock Physical Views

NOTE: Use the V Dock for the V 12 and the V 21 monitor.

1.4.1 Back View

1. Equipotential Lug
2. AC Receptacle (with an integrated cord retention clip)
3. V Hub Connector (MR 2-3)
4. Digital Video Interface (DV 1)
5. Central Station (CS 1)

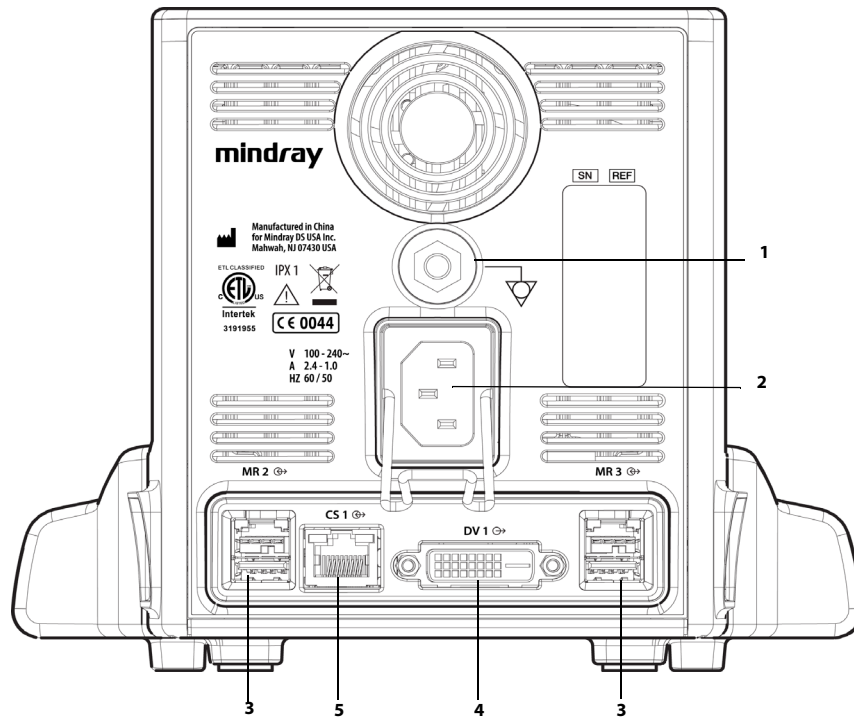

FIGURE 1-7 Example V 12 V Dock Back View

1.4.2 Right Side View

1. Serial Bus 3 (SB 3)
2. V Hub Connector (MR 4)

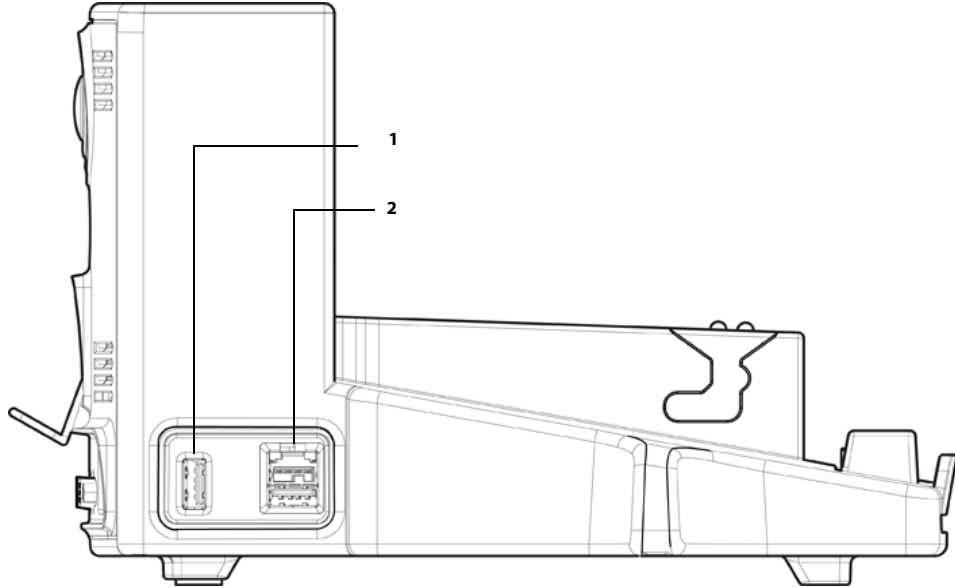

FIGURE 1-8 Example V 12 V Dock Right View

1.4.3 Left Side View

1. Serial Bus (SB 1-2)
2. Nurse Call (NC 1)

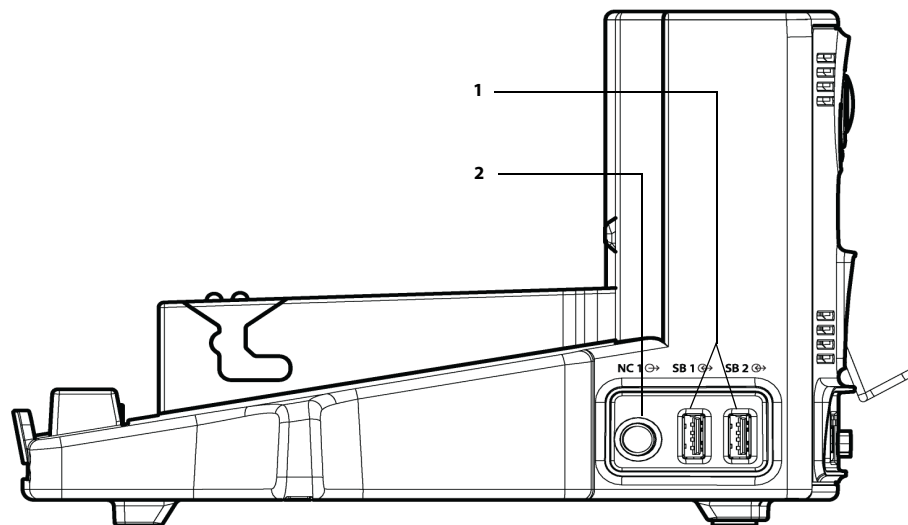

FIGURE 1-9 Example V 12 V Dock Left Side View

1.4.4 VPS Physical Views

Side View

1. IBP (P1-P2) connector
2. Non-invasive blood pressure (NIBP)
3. SpO₂ connector
4. ECG/EKG connector
5. Temperature (T1) connector
6. Release lever
7. Analog output protective door (2 analog outputs)

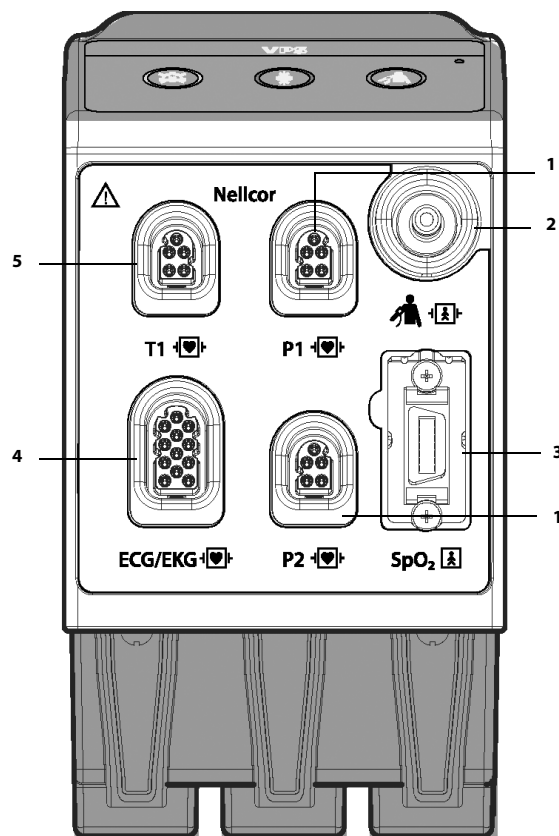

FIGURE 1-10 Example Nellcor VPS Side View

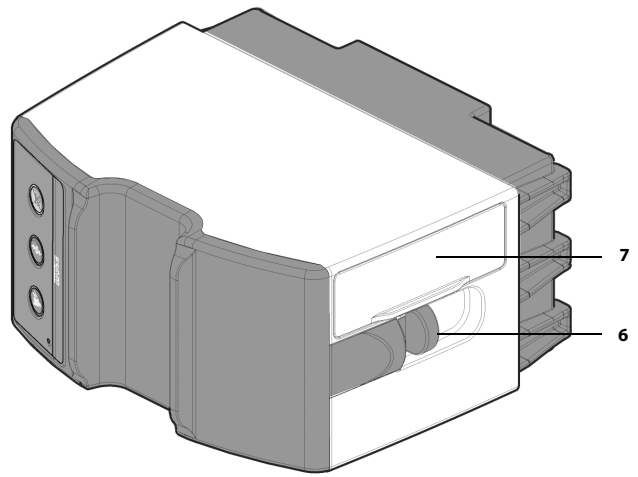

FIGURE 1-11 Example VPS Release Lever (Nelcor and Masimo)

Front View

1. Silence All alarms
2. Zero IBP transducers
3. Start/Stop NIBP
4. Indicator light

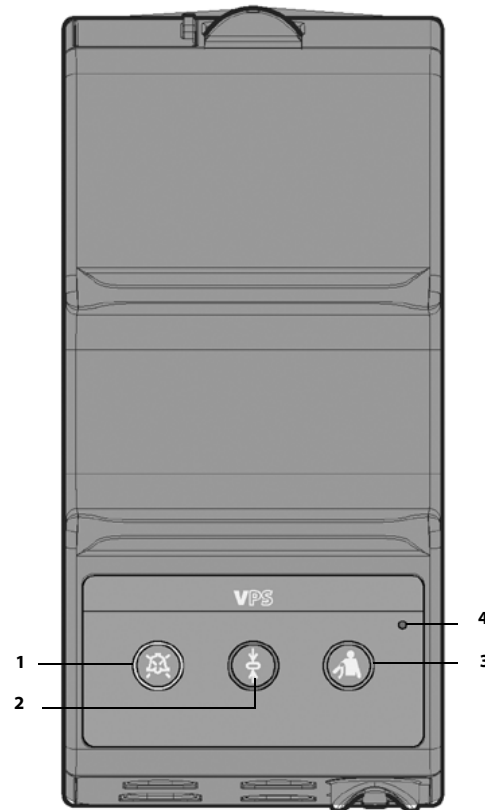

FIGURE 1-12 Example VPS Front View (Nellcor and Masimo)

This page intentionally left blank.

Getting Started

Introduction	2-2
Powering Unit On/Off	2-2
Using the V 21 Touch Pad	2-2
Main Display	2-3
Dialogs	2-8
Alarm Icons and Messages	2-9
Keyboard Dialog	2-11
Digital Keypad Dialog	2-12
Message Dialogs	2-13
Audio Levels Dialog	2-13
Battery Levels Dialog	2-15
System Information	2-16

2.1 Introduction

The **V 12/V 21** is a modular patient monitoring system. The system architecture allows users to customize, by removal or addition of modules, monitored parameters based on a patient's monitoring need or acuity level. The modular design simplifies the addition of monitoring additional parameters with the addition of parameter modules.

The **V 12/V 21** platform focuses on the philosophy of "Ease of Use" while incorporating traditionally highly complex monitoring parameters. The user interface minimizes menu layers and excessive user interaction to simplify patient care. The **V 12/V 21** maximizes the amount of viewable data through the use of a Portrait display orientation.

2.2 Powering Unit On/Off

CAUTION: When powering off the unit, do not continue to hold the power button down after the triple-beep signal is heard. Holding the power button down for more than three (3) seconds initiates a hard shutdown of the monitor which may cause unexpected and potentially harmful effects to the monitor database.

It is very important that the **V 12/V 21** unit is powered on and off properly. The power on button is located in the lower right corner of the monitor.

NOTE: Refer to "Right Side View" on page 1-12 for exact placement of power button.

Power On Unit

To power on unit, press and release power button momentarily.

NOTE: The message "starting up..." temporarily displays below the company logo of the splash screen during this process.

Power Off Unit

To power off unit, press the power button and release when a triple-beep signal is heard. This initiates the monitor shutdown process.

NOTE: The message "shutting down..." temporarily displays below the company logo of the splash screen during this process.

NOTE: The shutdown process takes approximately one (1) minute, during which time the monitor cannot be restarted.

2.3 Using the V 21 Touch Pad

NOTE: Only the **V 21** is equipped with a touch pad.

- Move a finger around the touch pad to change the cursor location on the display.
- Tap the touch pad once the cursor is positioned in the desired position on the display to open the dialog.

2.4 Main Display

The Main Display shows:

1. Header Bar
2. Message Area
3. Alarm status icon
4. Date and time
5. Module Status shortcut icon
6. Display Presets shortcut icon
7. Battery levels indicator (V 12 only)
8. Digital tiles
9. Navigation Area
10. Waveform tiles

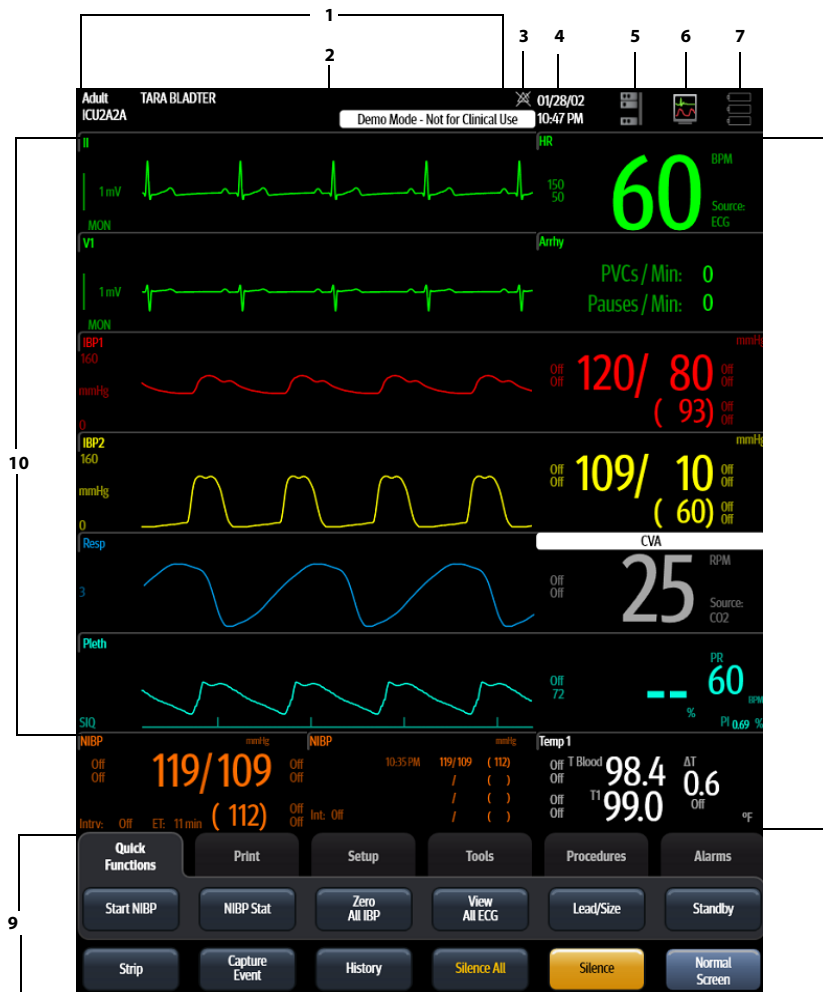

FIGURE 2-1 Example V 12/V 21 Main Display

Selecting the different areas of the Main Display opens various dialogs.

COMPONENT	DESCRIPTION
Header Bar	Accesses the Patient Info dialog where the patient's demographic information is changed.
Date and Time	Accesses the Time & Date dialog where the system time and date can be changed.
Module Status	Opens the Module Status dialog.
Display Presets	Accesses the Display Setup dialog where the Main Display parameters are selected.
Battery Levels	Accesses the Battery Levels dialog where battery status is checked.
Waveform tile	Accesses the respective parameter dialog. For example, selecting the Resp waveform tile opens the Resp dialog.
Digital tile	Accesses the respective parameter dialog. For example, selecting the Resp digital tile opens the Resp dialog.
Navigation button	Accesses the respective dialog.

2.4.1 System Status Message

System messages display in the Main Display Header Bar. TABLE 2-1 lists all the system messages. If there is more than one message to display, the messages scroll.

TABLE 2-1

MESSAGE	DESCRIPTION
Alarm Silenced For xxx	Silences all current alarms at the monitor for a user configurable time period. The Main Display contains a message indicating the alarms are silenced for a designated time period. If a new alarm occurs, the alarm sounds. NOTE: The Low Battery audible alarm is not affected by the Silence.
All Alarms Silenced For xxx	Silences all current and future alarms at the monitor for a user designated time period. The Main Display contains a message indicating the alarms are silenced for a designated time period. NOTE: The Low Battery audible alarm is not affected by the Silence.
All Alarms Permanently Silenced	Indicates that all alarms are permanently silenced on the monitor for a designated time period.
Communications Lost	Indicates communication with the central station is lost.
Fan Failure	Indicates the unit fan is non-functioning.
VPS Settings Synch in Progress	Indicates the VPS synchronization is in progress. NOTE: Refer to "VPS Synchronization" on page 5-6 for additional information.

TABLE 2-1

MESSAGE	DESCRIPTION
VPS Synchronization Complete	Indicates VPS synchronization is complete which includes the VPS settings and the VPS data. NOTE: Refer to "VPS Synchronization" on page 5-6 for additional information.
VPS Settings Synch Complete	Indicates VPS settings synchronization is complete but not the VPS data. NOTE: Refer to "VPS Synchronization" on page 5-6 for additional information.
All ECG	Indicates the Main Display is currently in the All ECG mode.
Low Battery	Indicates the battery runtime is below 20 minutes.
Demo Mode - Not for Clinical use	Indicates the monitor is in the demonstration mode.
Software Download Pending	Indicates software was downloaded and is pending installation.
Printer Error	Indicates printer management errors.

2.4.2 Navigation Area

The **Navigation Area** provides access to the monitors functions. This area contains one row of tabs and two rows of buttons. The buttons below the tabs vary based on the currently selected tab. The buttons located within the Quick Functions tab are user-configurable and may be modified by accessing the password protected System dialog. The bottom row of buttons is permanent and cannot be changed.

NOTE: Refer to "Configuring the Quick Functions Tab" on page 25-4 for additional information.

NOTE: If another tab is open in the Navigation Area and the touchscreen is idol for 30 seconds, the system times-out and displays the Quick Functions tab.

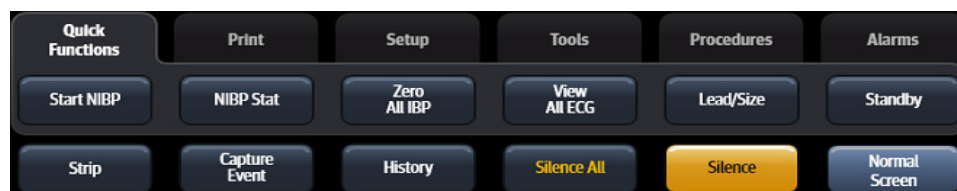

FIGURE 2-2 Example Default View of the Navigation Area (from Quick Functions Tab)

TABLE 2-2 lists the buttons and tabs available in the factory default **Navigation Area**.

TABLE 2-2

BUTTON	DESCRIPTION
Strip	Initiates a single strip or a continuous strip print request.
Capture Event	Saves an event to the event database.

TABLE 2-2 (Continued)

BUTTON	DESCRIPTION
History	Accesses the Trends, Events, and Full Disclosure dialogs.
Silence All	Silences all current and future alarms for the configured time period.
Silence	Silences the current alarms for the configured time period.
Normal Screen	Closes all dialogs and returns to the Main Display.

QUICK FUNCTIONS TAB

Start/Stop NIBP	Starts/Stops a NIBP measurement in progress. If there is no measurement in progress, the button reads Start NIBP . If there is a measurement progress, the button reads Stop NIBP .
NIBP Stat	Starts an immediate NIBP measurement.
Zero All IBP	Sets the current pressure for all invasive pressure channels to zero.
View All ECG	Displays all the ECG waveforms available based on the lead set currently in use.
Lead/Size	Accesses the Lead/Size dialog used to change the ECG waveform height or wave gain.
Standby	Places the monitor in the standby mode.

PRINT TAB

Continuous/Abort	Begins/ends strips from printing to the thermal printer.
Print 12 Lead	Prints a 12 Lead Report to the default printer.

NOTE: **The Print 12 Lead button is only available in the Print tab when 12 Lead is selected from the ECG Cable Type button on the ECG Setup tab.**

Print Setup	Accesses the Print Setup dialog where the clinician can configure which waveforms to print and where to print them.
Print Queue	Accesses the Print Queue dialog.

SETUP TAB

Patient Info	Accesses the Patient Info dialog.
Audio Levels	Accesses the Audio Levels dialog.
Display	Accesses the Display Setup dialog.
Parameters	Accesses the Parameter dialog.
System	Accesses the System Setup dialog.

TOOLS TAB

Calculators	Accesses the Calculators dialog.
Alarm Watch	Accesses the Alarm Watch dialog.
Remote View	Accesses the Remote View dialog.
System Information	Accesses the System Information dialog.
VAccess	Accesses the VAccess dialog.

NOTE: **The VAccess button is only available in the Tools tab if it is enabled in System Setup.**

TABLE 2-2 (Continued)

BUTTON	DESCRIPTION
PROCEDURES TAB	
	NOTE: These buttons are only available when using the Adult or Pediatric patient size.
C.O. Run	Accesses the Cardiac Output Runs dialog.
PAWP	Accesses the PAWP dialog.
PA Insertion	Accesses the PA Insertion dialog.
Hemo Calculations	Accesses the Hemodynamic Calculations dialog.
12 Lead	Accesses the 12 Lead dialog.
	NOTE: The 12 Lead button is only available in the Procedures tab when 12 Lead is selected from the ECG Cable Type button on the ECG Setup tab.
ALARMS TAB	
Limits	Accesses the Alarm Limits dialog.
Responses	Accesses the Responses dialog.
Arrhythmia	Accesses the Arrhythmia Alarm dialog.
Alarm Setup	Accesses the Alarm Setup dialog.

2.5 Dialogs

Dialogs may include the following components:

1. Active tab
2. Dialog name
3. Inactive tabs
4. Selected radio button
5. Unselected radio button
6. Selected check box
7. Unselected check box
8. Tab specific buttons
9. Dialog specific buttons

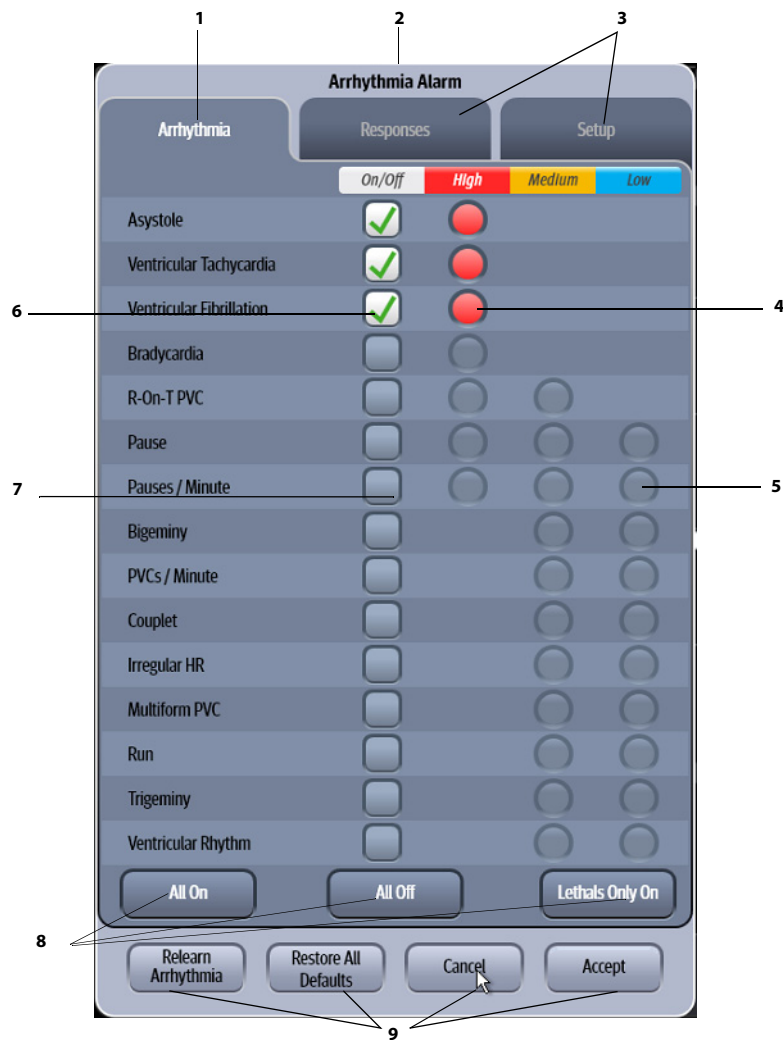

FIGURE 2-3 Example Arrhythmia Alarm Dialog

2.5.1 List Box

FIGURE 2-4 shows an example of a list box. The list box provides a list of available selections for a particular dialog button or item.



FIGURE 2-4 Example List Box

2.6 Alarm Icons and Messages

2.6.1 Alarm Icons

FIGURE 2-3 shows the icons that display in the header area of the Main Display related to alarm sounds.

TABLE 2-3

ICON	DESCRIPTION
	Indicates that any active alarms have been temporarily silenced.
	Indicates that all alarms have been permanently silenced.
NOTE: This icon is only present when the Silence All in the Alarm Setup tab is set to Permanent.	
	Indicates that one or more alarms are set to Off.

2.6.2 Parameter Messages

As shown in FIGURE 2-5 and FIGURE 2-6, each digital tile and waveform tile contains an area where parameter specific messages display.

NOTE: Individual parameter messages are discussed in each respective chapter.

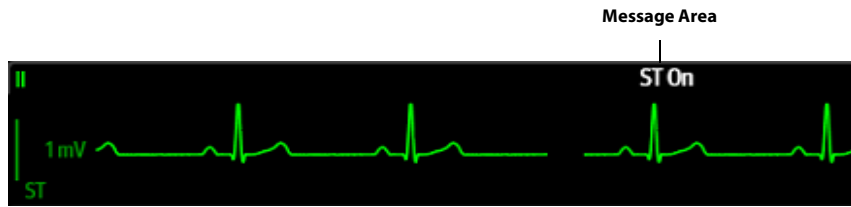

FIGURE 2-5 Example Waveform Tile Message Area



FIGURE 2-6 Example Digital Tile Message Area

2.7 Keyboard Dialog

The V 12/V 21 uses an on-screen keyboard which enables the clinician to enter alphanumeric information such as patient demographics, drug names, and passwords.

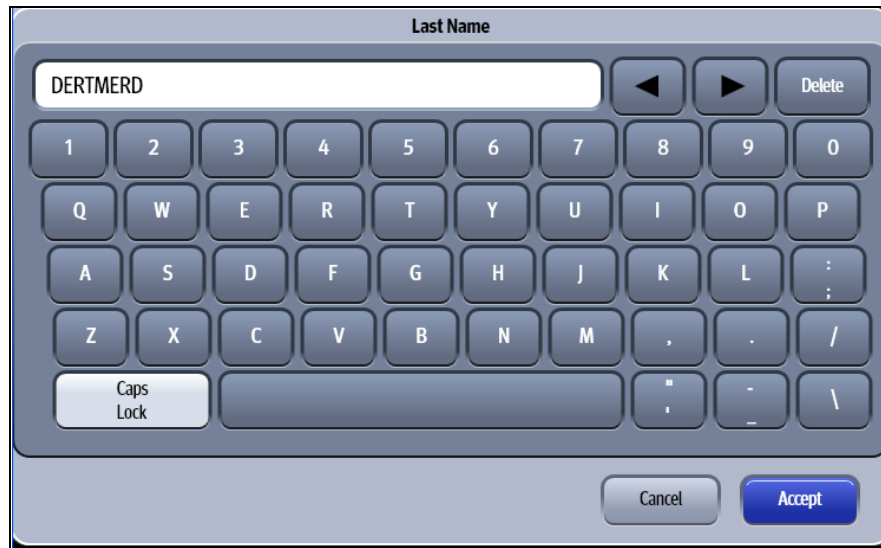



FIGURE 2-7 Example Keyboard Dialog

2.7.1 Using the Keyboard

The on-screen keyboard functions similarly to a standard PC keyboard.

1. Using the touch screen, enter the desired alphanumeric text.
2. To edit the alphanumeric text:
 - Select the  arrow key to move the cursor to the left.
 - Select the  arrow key to move the cursor to the right.
 - Select the **Delete** button to erase the text to the right of the cursor.
3. Select the **Cancel** or **Accept** button.
 - The **Cancel** button closes the dialog without saving the settings.
 - The **Accept** button saves the settings and closes the dialog.

2.8 Digital Keypad Dialog

The V 12/V 21 uses a digital keypad dialog to enter digital values.

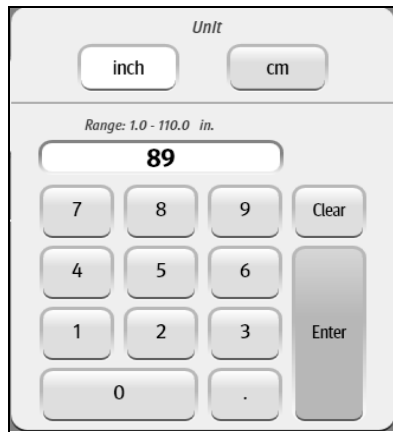

FIGURE 2-8 Example Digital Keypad with Unit of Measure



FIGURE 2-9 Example Digital Keypad without Unit of Measure

2.8.1 Using the Digital Keypad

1. Using the touch screen, enter a number within the range.

NOTE: To assist with the entry, the allowable range is shown above the text box.

2. If shown, select the unit of measure button (inch or cm) as shown in FIGURE 2-8.
3. Select the **Clear** button to delete an entry.
4. Select the **Enter** key to save the entry and close the dialog.

2.9 Message Dialogs

Message dialogs display in response to various actions. They require acknowledgement or confirmation before continuing. As an example, the message dialog in FIGURE 2-10 requires **No** to cancel the operation or **Yes** to proceed. Not all message dialogs use No or Yes. Other message dialogs may contain a Cancel or Accept button instead.

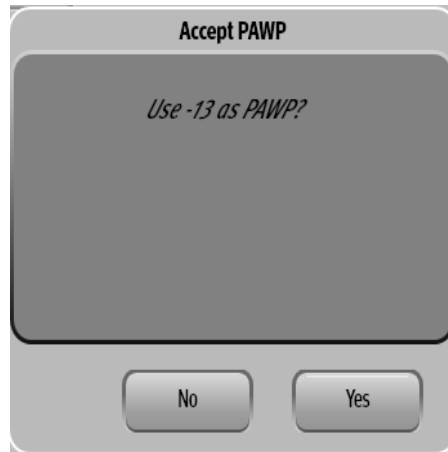

FIGURE 2-10 Example of a Confirmation Message Dialog

2.10 Audio Levels Dialog

The Audio Levels dialog (as shown in FIGURE 2-11) provides a means to configure the volume levels for the physiological and technical alarms and the systole beep.

The Audio Levels dialog contains:

1. Decrease audio volume button
2. Audio level indicator
3. Increase audio volume button
4. Audio off indicator

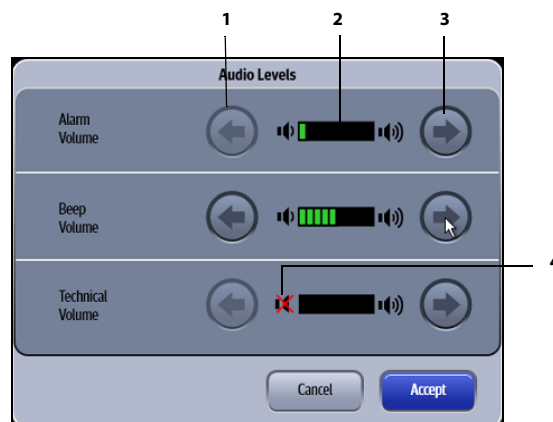





FIGURE 2-11 Example Audio Levels Dialog

NOTE: The touch screen sound or mouse click sound are disabled while making adjustments in the Audio Levels dialog. The purpose of this is to be able to hear the adjusted tone without the clicking sound.

2.10.1 Configuring Audio Levels

1. Select the **Setup** tab from the Navigation Area.
2. Select the **Audio Levels** button to display the Audio Levels dialog.
3. Adjust the volume levels.
 - Select the  arrow key to decrease the volume level.
 - Select the  arrow key to increase the volume level.

NOTE: The  icon indicates that the Beep Volume or Technical Volume was turned off. The Alarm Volume cannot be turned off.

NOTE: The factory default for all three volume levels is medium (shown in FIGURE 2-12).



FIGURE 2-12 Medium volume level

2.11 Battery Levels Dialog

When batteries are installed and the V 12 is functioning on battery power, the battery indicator provides a visual reference for the approximate charge level of the batteries. The Battery Levels dialog (as shown in FIGURE 2-13) indicates which batteries are currently installed; which batteries are currently being charged; and what the charge level is for each battery.

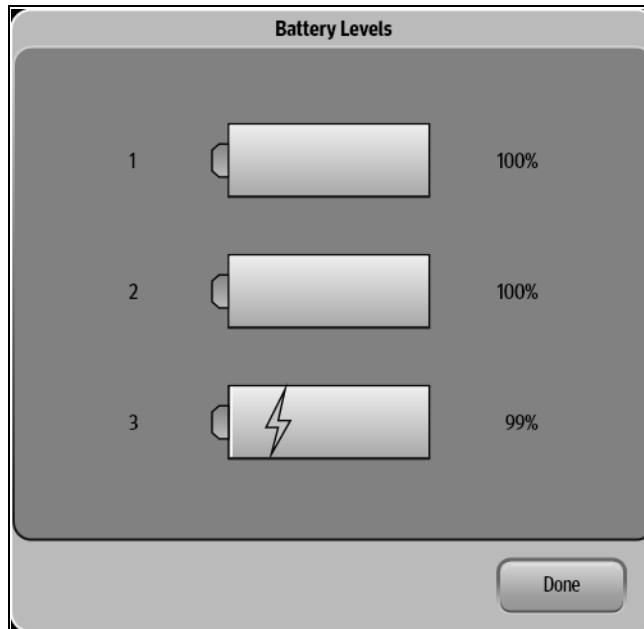

FIGURE 2-13 Example Battery Levels Dialog

NOTE: The  icon indicates that the battery is charging.

2.11.1 Battery Indicator Colors

- Red indicates that the battery is charged less than or equal to 25%.
- Yellow indicates that the battery is charged less than or equal to 50% but greater than 25%.
- Green indicates that the battery is charged less than or equal to 100% but greater than 50%.

2.12 System Information

To determine which software (BIOS, monitor) versions are installed on the **V 12/V 21** monitor:

1. Select the **Tools** tab from the Navigation Area.
2. Select **System Information**.
The System Information dialog displays (shown in FIGURE 2-14).

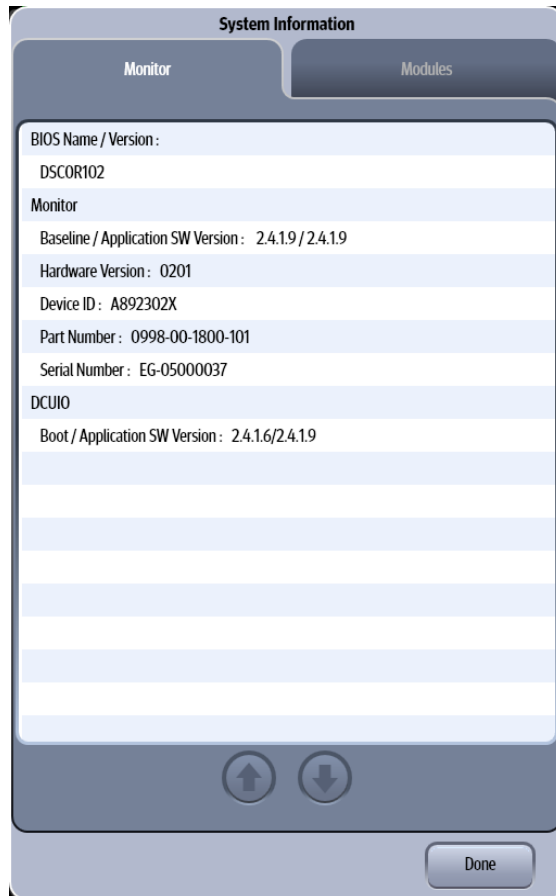

FIGURE 2-14 System Information Dialog

Display Setup

Introduction	3-2
Display Options Dialog.....	3-2
Display Options Troubleshooting.....	3-19

3.1 Introduction

The chapter describes all the functions in the Display Options dialog (as shown in FIGURE 3-1). This dialog provides access to display configuration, patient Standby, patient Discharge, and touch screen calibration among other things.

3.2 Display Options Dialog

The Display Options dialog provides access to display configuration, privacy mode, patient standby, patient discharge, various display modes, display lead size, and touch screen calibration.

3.2.1 Navigating to the Display Options Dialog

1. Select the Display Options icon  located in the upper right corner of the Header Bar.
OR
2. Select the **Setup** tab from the Navigation Area.
3. Select the **Display** button.
The Display Options dialog displays (as shown in FIGURE 3-1).

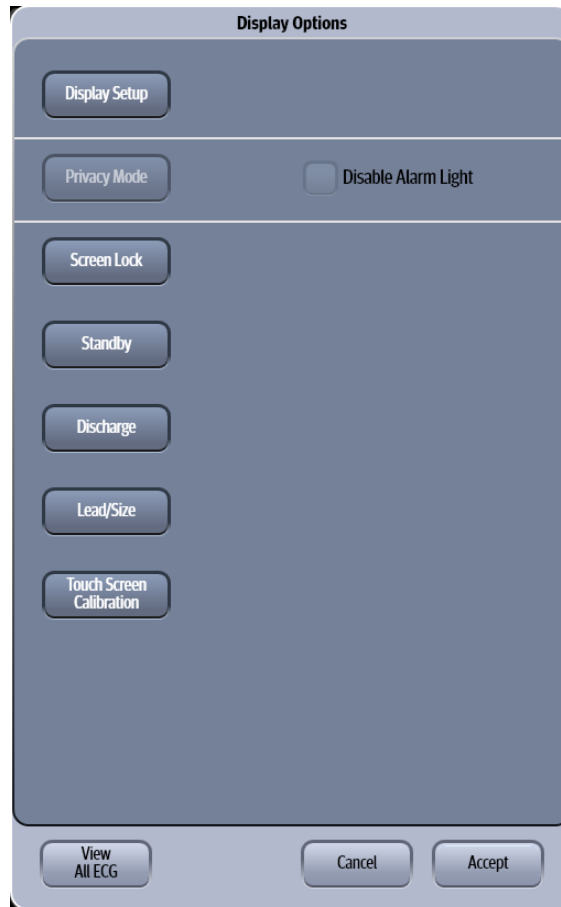

FIGURE 3-1 Example Display Options Dialog

4. Select the buttons described in TABLE 3-1 to configure the tab.

TABLE 3-1

BUTTON	DESCRIPTION / COMMENTS
Display Setup	Opens the Display Setup dialog where the display configurations are set. NOTE: Refer to "Configuring Display Presets" on page 3-3 for additional information.
Privacy Mode	Hides the patient data and suppresses alarm notification at the monitor. The purpose of Privacy Mode is to have virtually NO alarm notification at bedside, unless LED is active at bedside. NOTE: This button is only available when the patient is being monitored at a central monitoring station. NOTE: Refer to "Privacy Mode" on page 3-15 for additional information.
Screen Lock	Disables the touch screen for a 10 second period for cleaning purposes. NOTE: Refer to "Screen Lock Mode" on page 3-16 for additional information.
Standby	Places the monitor in the standby mode. NOTE: Refer to "Standby Mode" on page 3-16 for additional information.
Discharge	Discharges the patient. NOTE: Refer to "Discharge Mode" on page 3-16 for additional information.
Lead/Size	Opens the Lead/Size dialog. NOTE: Refer to "Changing Lead/Size" on page 3-17 for additional information.
Touch Screen Calibration	Activates touch screen calibration. NOTE: Refer to "Touch Screen Calibration" on page 3-17 for additional information.

3.2.2 Configuring Display Presets

Display presets are predefined display configurations or layouts. The V 12/V 21 supports 10 factory display presets. There are five presets and five empty presets from which to choose. Configure the presets based on the needs of the individual department or unit, clinicians preference, or the patient's condition. This tab and the factory default presets are described in the following section.

3.2.2.1 Display Preset Configurations

Each display preset shows the position of the digital and waveform tiles, if applicable.

Preset 1 - V 12 Monitor

TABLE 3-2 provides the factory default configuration for Preset 1.

TABLE 3-2

WAVEFORM TILE		DIGITAL TILE
II		HR
V/Vx/V1		Arrhy
Off		Off
IBP1		IBP1
IBP2		IBP2
Resp		Resp
Pleth		SpO ₂
NIBP	NIBP List	Temp 1

Preset 1 - V 21 Monitor

TABLE 3-3 provides the factory default configuration for Preset 1.

TABLE 3-3

WAVEFORM TILE		NUMERIC TILE
II		HR
V/Vx/V1		Arrhy
Off		Off
Off		Off
Off		Off
Off		Off
Off		Off
IBP1		IBP1
IBP2		IBP2
Resp		Resp
Pleth		SpO ₂
NIBP	NIBP List	Temp 1

Preset 2 - V 12 Monitor

TABLE 3-4 provides the factory default configuration for Preset 2.

TABLE 3-4

WAVEFORM TILE		DIGITAL TILE
II		HR
V/Vx/V1		Arrhy
IBP1		IBP1
IBP2		IBP2
IBP3		IBP3
Pleth		SpO ₂

TABLE 3-4

CO	ST	Resp
NIBP	NIBP List	Temp 1

Preset 2 - V 21 Monitor

TABLE 3-5 provides the factory default configuration for Preset 2.

TABLE 3-5

WAVEFORM TILE		NUMERIC TILE
II		HR
V/Vx/V1		Arrhy
Vy/V2		ST
I		Off
III		Off
IBP1		IBP1
IBP2		IBP2
IBP3		IBP3
CO ₂		CO ₂
Pleth		SpO ₂
CO	NIBP	Resp
Off	NIBP List	Temp 1

Preset 3 - V 12 Monitor

TABLE 3-6 provides the factory default configuration for Preset 3.

TABLE 3-6

WAVEFORM TILE		DIGITAL TILE
II		HR
V/Vx/V1		Arrhythmia
IBP1		IBP1
IBP2		IBP2
Pleth		SpO ₂
Off	Off	Off
CO	ST	Resp
NIBP	NIBP List	Temp 1

Preset 3 - V 21 Monitor

TABLE 3-7 provides the factory default configuration for Preset 3.

TABLE 3-7

WAVEFORM TILE		NUMERIC TILE
II		HR
V/Vx/V1		Arrhy
ST Dev 12 Lead		Off
IBP1		IBP1
IBP2		IBP2

TABLE 3-7

Off		Off
Off		Off
Off		Off
Pleth		SpO ₂
Off	Off	Resp
CO	NIBP	Temp 1
Alarm Watch	NIBP List	Temp 2

Preset 4 - V 12 Monitor

TABLE 3-8 provides the factory default configuration for Preset 4.

TABLE 3-8

WAVEFORM TILE	DIGITAL TILE
II	HR
V/Vx/V1	Arrhy
I	NIBP
IBP1	IBP1
IBP2	IBP2
IBP3	IBP3
Pleth	SpO ₂
Resp	Resp

Preset 4 - V 21 Monitor

TABLE 3-9 provides the factory default configuration for Preset 4.

TABLE 3-9

WAVEFORM TILE	NUMERIC TILE
II	HR
V/Vx/V1	Arrhy
Vy/V2	ST
IBP1	IBP1
IBP2	IBP2
IBP3	IBP3
IBP4	IBP4
Pleth	SpO ₂
Resp	Resp
CO ₂	CO ₂
Off	Off
Off	NIBP

Preset 5 - V 12 Monitor

TABLE 3-10 provides the factory default configuration for Preset 5.

TABLE 3-10

WAVEFORM TILE		DIGITAL TILE
II		HR
Pleth		SpO ₂
Off		Off
Off		Off
Off		Off
Off		Off
Off		Off
NIBP	Off	Resp

Preset 5 - V 21 Monitor

TABLE 3-11 provides the factory default configuration for Preset 5.

TABLE 3-11

WAVEFORM TILE		NUMERIC TILE
II		HR
Pleth		SpO ₂
Off		Off
Off		Off
Off		Off
Off		Off
Off		Off
Off		Off
Off		Off
Off		Off
Off		Off
NIBP	Off	Resp

Empty Presets - V 12 Monitor

TABLE 3-12 provides the factory default configuration for all Empty Presets.

TABLE 3-12

WAVEFORM TILE		DIGITAL TILE
II		HR
Off		Off
Off		Off
Off		Off
Off		Off
Off		Off
Off		Off
Off	Off	Off

Empty Preset - V 21 Monitor

TABLE 3-13 provides the factory default configuration for the Empty Preset.

TABLE 3-13

WAVEFORM TILE		NUMERIC TILE
II		HR
Off		Off
Off		Off
Off		Off
Off		Off
Off		Off
Off		Off
Off		Off
Off		Off
Off		Off
Off		Off
Off	Off	Off

3.2.3 Editing a Display Preset

Edit an existing preset or configure an Empty preset:

1. Select the **Setup** tab from the Navigation Area.
2. Select the **Display** button, then select the **Display Setup** button.
The Display Setup dialog displays (as shown in FIGURE 3-2).

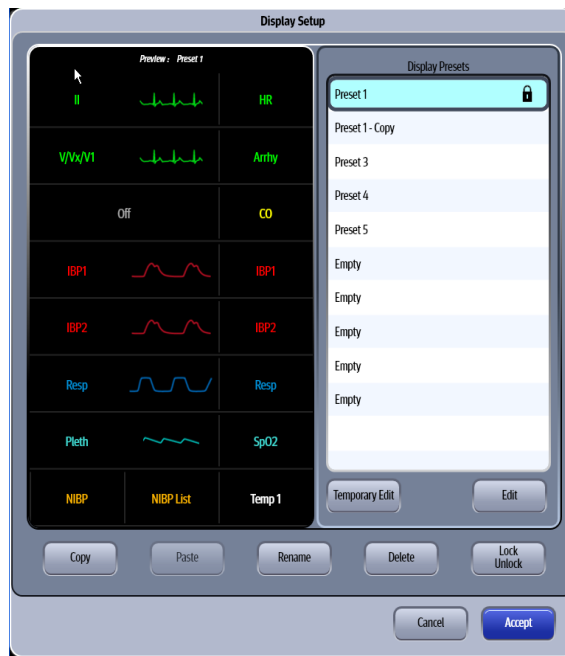

FIGURE 3-2 Example Display Setup Dialog (with Locked Presets)

3. Select a display preset from the list.
4. Select the **Edit** button. Enter a preset password if prompted. The **“Select an area from the grid on the left then choose a parameter from the corresponding list that appears in this area.”** message displays.
5. Select an area on the grid to see a list of available parameters.
A list of digital or waveform parameters displays to the right of the grid (as shown in FIGURE 3-3).

NOTE: **The list of available parameters is dependent on whether a waveform tile or a digital tile was selected in the grid.**

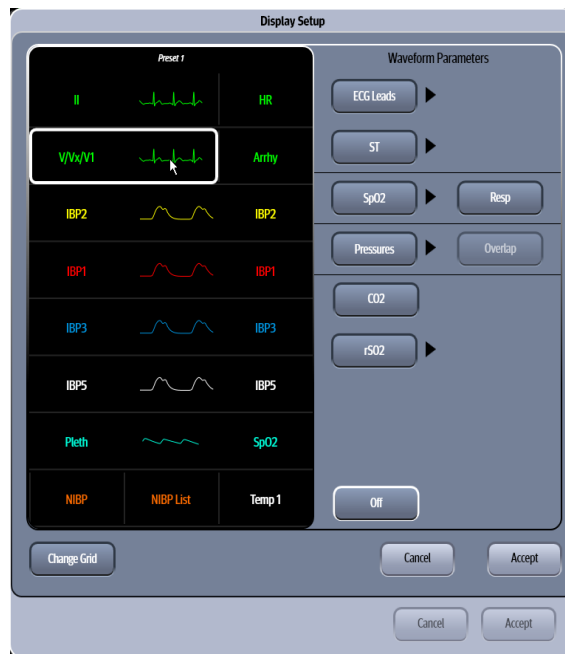



FIGURE 3-3 Example Display Setup Grid (Overlap button disabled)

6. Select a parameter button.

NOTE: The arrow beside a parameter button (for example, ) indicates that there is a submenu with additional choices available.

7. Select a parameter to add or change the existing parameter.

OR

Select the **Off** button to leave that portion of the grid empty.

NOTE: The HR parameter tile and the topmost ECG waveform tile cannot be turned off.

8. Optional - repeat steps 6 and 7 until edits are complete.
9. Select the **Cancel** or **Accept** button to return to the Main Display.
 - The **Cancel** button closes the dialog without saving the settings.
 - The **Accept** button saves the settings and closes the dialog.

3.2.4 Locking/Unlocking Presets

NOTE: The factory default for all display presets is unlocked.

NOTE: System Administrators may unlock a password. Refer to "Configuring the General Tab" on page 25-3 for additional information.

1. Select the **Setup** tab from the Navigation Area.
2. Select the **Display** button, then select the **Display Setup** button. The Display Setup dialog displays (as shown in FIGURE 3-4).



FIGURE 3-4 Example Display Setup Dialog (Locked Presets)

3. Select the preset from the Display Presets list that requires locking/unlocking.
4. Select the **Lock Unlock** button.
The Create Password or Enter Password keyboard displays.
5. Enter a password, then select the **Accept** button.
 - Locked presets display with a locked icon  beside the preset name (as shown in FIGURE 3-4).
 - Unlocked presets display without the locked icon.

3.2.5 Temporarily Editing a Locked Display Preset

Temporary changes may be made to a locked preset. Changes remain active until any of the following occur:

- Patient is discharged
- Device is restarted
- Original screen layout is restored
- Another preset is edited

To edit a locked preset:

1. Select the **Setup** tab from the Navigation Area.
2. Select the **Display** button, then select the **Display Setup** button.
The Display Setup dialog displays (as shown in FIGURE 3-2).
3. Select a locked display preset from the list.

NOTE: Locked presets display with a locked icon  beside the preset name.

4. Select the **Temporary Edit** button. The message “**Select an area from the grid on the left then choose a parameter from the corresponding list that appears in this area.**” displays.

5. Follow steps 5 through 9 in the "Editing a Display Preset" on page 3-8 until the edits are complete.

NOTE: Temporary presets display with the word (temporary) (for example, Preset 3(temporary)) beside the preset name.

3.2.6 Restoring a Temporary Preset

1. Select the **Setup** tab from the Navigation Area.
2. Select the **Display** button, then select the **Display Setup** button. The Display Setup dialog displays (as shown in FIGURE 3-2).
3. Select a temporary preset from the Display Presets list.
4. Select the **Restore** button. The preset is restored to its original configuration.

NOTE: The **Restore** button changes to **Rename** once the Temporary preset is restored.

5. Select the **Cancel** or **Accept** button to return to the Main Display.
 - The **Cancel** button closes the dialog without saving the settings.
 - The **Accept** button saves the settings and closes the dialog.

3.2.7 Copying and Pasting a Display Preset

1. Select the **Setup** tab from the Navigation Area.
2. Select the **Display** button, then select the **Display Setup** button. The Display Setup dialog displays (as shown in FIGURE 3-2).
3. Select the preset you wish to copy from the Display Presets list.
4. Select the **Copy** button.
5. Select a preset in the Display Presets list where the copied preset will be pasted.
6. Select the **Paste** button. A copy of the preset is placed in the Display Presets list. An example of a copied preset name is "Preset # - Copy". The # varies based on the preset copied but the "Copy" is standard until the copied preset is renamed.

NOTE: The Display Presets list can only display one preset "Copy" at a time. Try to copy and paste a second preset, and the system requires that the preset be named before it is pasted.

7. Select the **Cancel** or **Accept** button to return to the Main Display.
 - The **Cancel** button closes the dialog without saving the settings.
 - The **Accept** button saves the settings and closes the dialog.

3.2.8 Renaming a Preset

1. Select the **Setup** tab from the Navigation Area.
2. Select the **Display** button, then select the **Display Setup** button. The Display Setup dialog displays (as shown in FIGURE 3-2).
3. Select the preset you wish to rename from the Display Presets list.
4. Select the **Rename** button. The keyboard dialog displays.

5. Enter a preset name.

NOTE: The preset cannot be named as “Empty”.

6. Select the **Cancel** or **Accept** button to return to the Main Display.
 - The **Cancel** button closes the dialog without saving the settings.
 - The **Accept** button saves the settings and closes the dialog.

3.2.9 Renaming an Empty Preset

1. Follow steps 1 through 3 in the "Renaming a Preset" on page 3-12.
2. Select the **Edit** button.
3. Select a display preset from the list.
4. Select the **Edit** button. Enter a preset password if prompted. The “**Select an area from the grid on the left then choose a parameter from the corresponding list that appears in this area.**” message displays.
5. Select an area on the grid to see a list of available parameters. A list of digital or waveform parameters displays to the right of the grid (as shown in FIGURE 3-3).

NOTE: The list of available parameters is dependent on whether a waveform tile or a digital tile was selected in the grid.

6. Optional - select the **Change Grid** button to choose a different display grid. The selected grid dictates the allowable number of waveforms and numeric tiles that can display in the preset.
7. Select a parameter button.

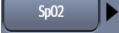
NOTE: The arrow beside a parameter button (for example, ) indicates that there is a submenu with additional choices available.

8. Select a parameter to add or change the existing parameter.

OR

Select the **Off** button to leave that portion of the grid empty.

NOTE: The HR parameter tile and the topmost ECG waveform tile cannot be turned off. The V 12 monitor supports a minimum of three (3) rows in the display setup. The V 21 monitor supports a minimum of four (4) rows in the display setup.

9. Optional - repeat steps 6 and 7 until edits are complete.
10. Select the **Accept** button. The keyboard dialog displays.
11. Enter a preset name.
12. Select the **Cancel** or **Accept** button to return to the Main Display.
 - The **Cancel** button closes the dialog without saving the settings.
 - The **Accept** button saves the settings and closes the dialog.

3.2.10 Deleting a Preset

1. Select the **Setup** tab from the Navigation Area.
2. Select the **Display** button, then select the **Display Setup** button. The Display Setup dialog displays (as shown in FIGURE 3-2).

3. Select the preset you wish to delete from the Display Presets list.
4. Select the **Delete** button.
The name of the deleted preset displays as Empty.

NOTE: **A password is required if the preset is locked.**

NOTE: **The Empty preset cannot be deleted.**

5. Select the **Cancel** or **Accept** button to return to the Main Display.
 - The **Cancel** button closes the dialog without saving the settings.
 - The **Accept** button saves the settings and closes the dialog.

3.2.11 Overlapping Waveform

The **V 12/V 21** display grid allows up to four IBPs, displayed in pairs of two, to overlap. The following must occur before the **Overlap** button enables in the Display Setup dialog.

- Requires at least two IBP channels
- Second waveform must be added to the waveform area in the grid
- The IBP channels must be stacked in the grid (one on top of the other)

To add an overlapping IBP waveform to the display grid:

NOTE: **Refer to "IBP Tile Layouts" on page 11-12 for additional information.**

1. Select the **Setup** tab from the Navigation Area.
2. Select the **Display** button, then select the **Display Setup** button.
3. Select a preset from the list, then select the **Edit** button.
4. Select a waveform area on the grid.
A list of waveform parameters display to the right of the grid (as shown in FIGURE 3-3).
5. If there are currently no IBP waveform channels in the grid, add one.
6. Add a second IBP waveform channel to the grid below the first IBP channel.
The **Overlap** button enables.
7. Select the **Overlap** button.
The two waveform channels display in one grid cell instead of two cells.
8. Optional - If adding a second set of overlapping waveforms, repeat step 5-7.
9. Select the **Cancel** or **Accept** button.
 - The **Cancel** button closes the dialog without saving the settings.
 - The **Accept** button saves the settings and closes the dialog.

3.2.12 Changing IBP Waveform Overlap Settings

Change the configuration for either of the two overlapping IBP waveforms from the Main Screen.

1. Select the overlapping waveforms from the Main Screen to open the Overlapping Waveform dialog (as shown in FIGURE 3-5).

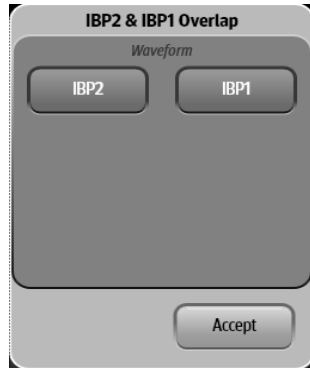

FIGURE 3-5 Example Overlapping Waveform Dialog

2. Select one of the IBP channel buttons.
The respective IBP Waveform tab opens.
3. Make the needed changes in the IBP dialog.

NOTE: Refer to "Configuring the IBP Waveform" on page 11-5 for additional information.

4. Select the **Accept** button.

3.2.13 Undoing an IBP Waveform Overlap

1. Select the **Setup** tab from the Navigation Area.
2. Select the **Display** button, then select the **Display Setup** button.
3. Select the preset from the Display Presets list which contains the overlapping waveforms, then select the **Edit** button.
4. Select the overlapping waveforms tile.
5. Select the **Undo Overlap** button.
6. Select the **Cancel** or **Accept** button.
 - The **Cancel** button closes the dialog without saving the settings.
 - The **Accept** button saves the settings and closes the dialog.

3.2.14 Privacy Mode

The Privacy Mode hides the patient data and suppresses alarm notification at the monitor while still monitoring the patient. This feature is only available when a patient is connected to a central monitoring system. The central station displays the patient data and provides alarm notification while the patient monitor is in this mode. If communication with the central station is lost or a module is added or removed, the monitor automatically exits the Privacy Mode. While in this mode, the display alarm light or LED, located at the top of the monitor, may be enabled or disabled.

NOTE: Refer to "Display Options Dialog" on page 3-2 for information.

NOTE: This button is only available when the patient is being monitored at a central monitoring station.

To enter Privacy Mode:

1. Select the **Setup** tab from the Navigation Area.
2. Select the **Display** button.
3. Check or uncheck the Disable Alarm Light check box in the Display Options dialog.

NOTE: Selecting the **Disable Alarm Light** check box disables the alarm lights/indicators. Refer to "V 12/V 21 Physical Views" on page 1-5 for additional information.

4. Select the **Privacy Mode** button.
The display clears and the screen reads **privacy mode**.

3.2.15 Screen Lock Mode

The Screen Lock mode disables the touch screen for 10 seconds. Enter this mode if the display is being cleaned. While in this mode, a timer countdown is shown indicating how much time is remaining.

To enter Screen Lock mode:

1. Select the **Setup** tab from the Navigation Area.
2. Select the **Display** button
3. Select the **Screen Lock** button.
The display indicates that the screen is locked and counts down the time remaining until it exits the mode and returns to the Main Screen. The timeout is 10 seconds.

3.2.16 Standby Mode

Refer to "Placing a Patient in Standby" on page 6-7 for additional information.

3.2.17 Discharge Mode

Refer to "Discharging a Patient" on page 6-5 for additional information.

3.2.18 View All ECG Mode





The View All ECG mode displays all the ECG waveforms available based on the lead set currently in use. Enter this mode when using a 5 lead, 6 lead, or 12 lead.

To enter the View All ECG Mode:

1. Select the **Setup** tab from the Navigation Area.
2. Select the **Display** button, then select the **View All ECG** button.
The Display Options dialog automatically closes and the first six (6) ECG waveforms populate the ECG waveforms tiles.
3. Optional - If using a 12 lead set with the **V 12**, select the **View All ECG** button a second time to view the next six (6) leads.
4. To return to the display mode, continue to select the View All ECG button until the display mode displays.

3.2.19 Changing Lead/Size

The Lead/Size dialog provides a vehicle to change size of the ECG waveforms at the display when using more than three ECG leads.

1. Select the **Setup** tab from the Navigation Area.
2. Select the **Display** button, then select the **Lead/Size** button.
The Lead/Size dialog displays.
3. Select the ECG lead by using the  and  scroll buttons. The leads available are based on the lead set currently in use.
4. Select the lead size by using the  and  scroll buttons. The waveform sizes available are: 0.125 cm/mv, 0.25 cm/mv, 0.5 cm/mv, 1 cm/mv, 2 cm/mv, 4cm/mv.
5. Select the **Done** button.

3.2.20 Touch Screen Calibration

NOTE: **Recalibrate the touch screen whenever the touch interface becomes difficult to maneuver.**

1. Select the **Setup** tab from the Navigation Area.
2. Select the **Display** button, then select the **Touch Screen Calibration** button.
3. Touch and hold the areas where indicated. Release the area when indicated (as shown in FIGURE 3-6).

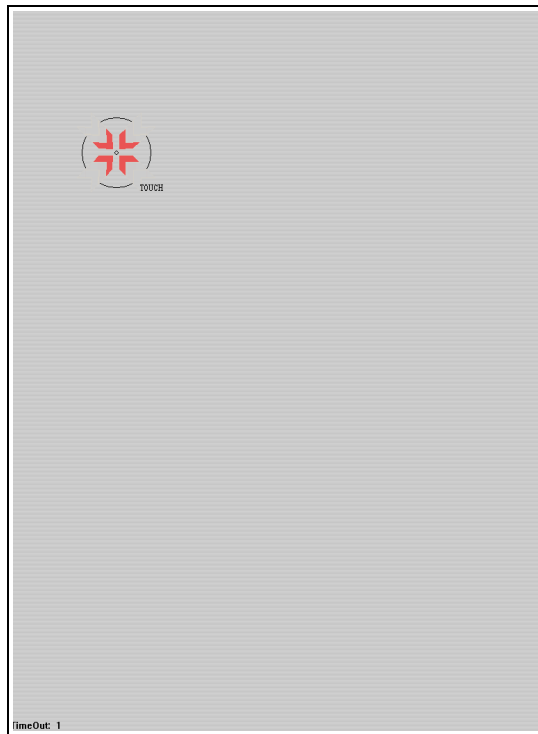

FIGURE 3-6 Example Calibration Display

4. Select the **Cancel** or **Accept** button.
 - The **Cancel** button returns to the monitoring display without recalibrating.
 - The **Accept** button returns to the monitoring display and recalibrates the display.

NOTE: **If the Cancel or Accept button is not selected within 90 seconds, the calibration is automatically cancelled.**

3.3 Display Options Troubleshooting

MESSAGE/PROBLEM	REASON	SOLUTION
Cannot copy display preset.	An Empty preset was selected.	Select a configured preset.
The Copy button is disabled when the preset is selected.	An Empty preset was selected.	Select a configured preset.
There is no image on the display.	Monitor is off.	Turn monitor on.
	Monitor is not properly seated in V Dock.	Reseat monitor in V Dock.
	Monitor is not plugged into power source.	Plug monitor into power source.
Desired parameters do not display on monitor.	Parameter(s) not included in Display Preset.	Refer to "Configuring Display Presets" on page 3-3 for instructions on modifying the preset.
Monitor is blank and reads "standby mode."	The Standby button was selected in the Display Options dialog.	Touch the display to resume monitoring.
Touch screen is difficult to maneuver.	Display needs to be calibrated.	Refer to "Configuring Display Presets" on page 3-3 for instructions on touch screen calibration.
Only see ECG leads in the waveform tiles.	Display is in the View All ECG mode.	Select the View All ECG button in the Display Options dialog.
Overlap button in Display Setup dialog not enabled.	A digital parameter tile is selected.	Select a waveform tile.
	A waveform tile is selected but it is not directly above or below another IBP waveform channel.	Select a waveform tile that is directly above or below an existing IBP waveform channel.

This page intentionally left blank.

Mechanical Functions

Introduction	4-2
V 12	4-2
V Dock	4-12
V 21	4-16
V Hub	4-18
Rolling Stand	4-24
Thermal Recorder	4-27
Mechanical Functions Troubleshooting	4-29

4.1 Introduction

This chapter describes the docking and undocking the **V 12**, battery installation, module installation, the V Hub, and V Dock mounting.

4.2 V 12

4.2.1 V 12 Docking

NOTE: When the **V 12** is attached to the **V Dock** and operating on batteries, it does not communicate with the central station.

1. Hold the **V 12** by the side grips, or top handle, and vertically lower it onto the top of the V Dock, so that the alignment pins on the bottom of the **V 12** engage with the alignment channel on the top of the V Dock.
2. Push the **V 12** backward onto the V Dock (shown in FIGURE 4-1), until the front latching bar moves upward, with a corresponding audible click.



FIGURE 4-1

OR

1. Reposition your hands so that your thumbs or palms press against the front surface of the **V 12**, near the lower corners, and other fingers grip around the protrusions on the side of the V Dock.
2. Squeeze your grip so that the **V 12** moves backward onto the V Dock (shown in FIGURE 4-2), until the front latching bar moves upward, with a corresponding audible click.

**FIGURE 4-2**

4.2.2 V 12 Undocking

1. Grab around both sides of the **V 12**, at the two side grip locations, with your palms firmly pressing against front edges of the **V 12**, and your fingers staged to grip the side actuators.
2. Close your grip against both actuators (shown in FIGURE 4-3). The latching bar on the V Dock moves downward, then the **V 12** pushes forward on the V Dock.
3. Lift the **V 12** up and away from the V Dock.

**FIGURE 4-3**

4.2.3 Battery Installation

1. With one finger, press against the finger grip on the battery door (shown in FIGURE 4-4), then slide the door backward.



FIGURE 4-4

2. With a finger, grab around the front edge of the door and swing it open (shown in FIGURE 4-5).



FIGURE 4-5

3. Reposition your hand against the inside surface of the door to keep it in the open position (shown in FIGURE 4-6).

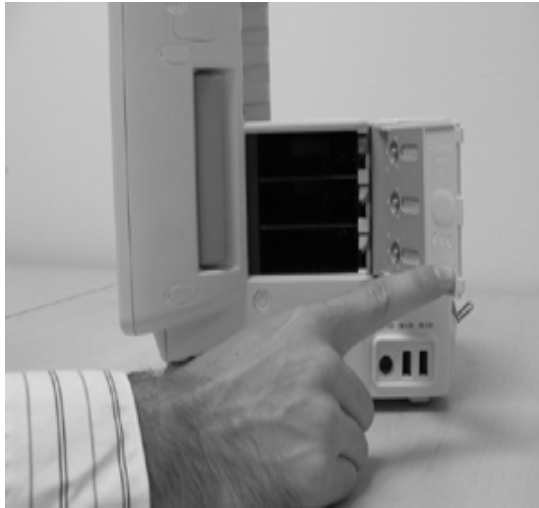
**FIGURE 4-6**

4. With the other hand, pick up a battery and install it into one of the three revealed battery bays, pushing it inward until the battery latch engages the battery, with a corresponding audible click (shown in FIGURE 4-7). (Avoid pressing against the circular button on the end of the battery, to avoid inadvertent checking of battery charge.)

**FIGURE 4-7**

5. Swing the door toward the closed position, align the three tabs on the front edge of the door with the three slots in the **V 12** housing and, while pressing the door flush to the housing, slide it forward, until it latches (shown in FIGURE 4-8).

**FIGURE 4-8**

4.2.4 Battery Removal

1. With one finger, press against the finger grip on the battery compartment door (shown in FIGURE 4-9), then slide the door backward.

**FIGURE 4-9**

2. With a finger, grab around the front edge of the door and swing it open (shown in FIGURE 4-10).

**FIGURE 4-10**

3. With the same or other hand, prepare to receive the desired battery by positioning your fingers close or against the battery. Press downward against the release button adjacent to the desired battery (shown in FIGURE 4-11). The corresponding battery ejects from the battery bay. Grab it and remove it completely from the **V 12** (shown in FIGURE 4-12).

**FIGURE 4-11****FIGURE 4-12**

4. Swing the door toward the closed position, align the three tabs on the front edge of the door with the three slots in the **V 12** housing and, while pressing the door flush to the housing, slide it forward, until it latches (shown in FIGURE 4-13).



FIGURE 4-13

4.2.5 Battery Charge Checking

- Press the elastomeric button (shown in FIGURE 4-14) in the battery door that corresponds to the battery that you desire to check, until the button on the end of the battery is actuated, with a corresponding click. The charge status LED's on the end of the battery lights according to the amount of charge in the battery, and is visible through the narrow window in the door.



FIGURE 4-14

4.2.6 Module Installation

- Pick up a module and align it with a group of module bays on the **V 12** sufficient to accommodate the module. (For example, a VPS requires a set of three adjacent module bays.) modules may be installed in either of two orientations (rotated 180° apart). Push the module inward until the module latch engages the latching pins on the **V 12** (shown in FIGURE 4-16), with a corresponding audible click. (Avoid pressing against any circular buttons on the end of the module, to avoid inadvertent actuation of the button function.)

NOTE: A VPS is required to monitor any patient parameters.



FIGURE 4-15



FIGURE 4-16

4.2.7 Module Indicator Lights

Whenever a module is inserted into a powered integrated V Hub or an external V Hub, the module indicator lights illuminate to designate the status of the module.

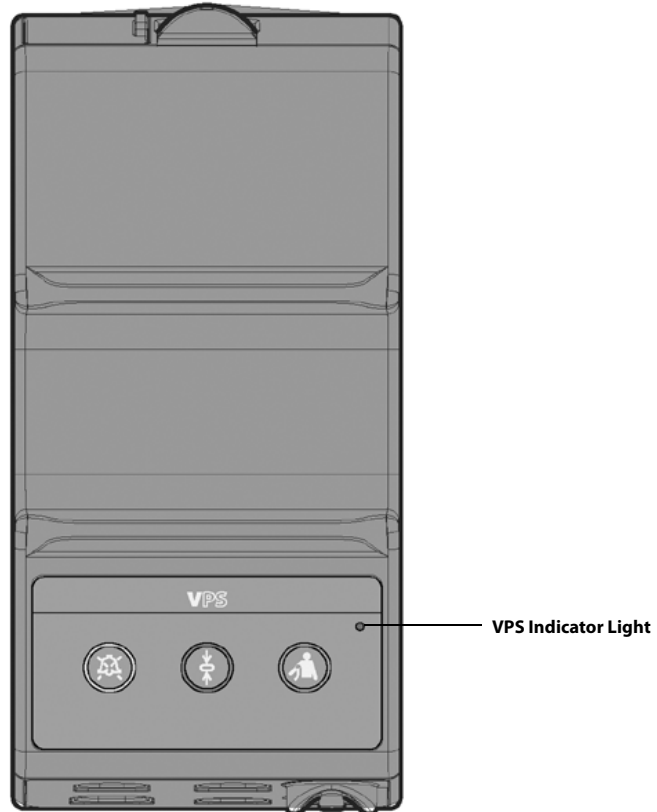
**INDICATOR LIGHT COLOR**

No light
Amber
Green

STATUS

No communication, VPS disconnected
Power on but module is not communicating
Power on and module is communicating

4.2.8 Module Removal

1. Grip around the desired module with your thumb positioned against the module release trigger and your index finger (and/or other finger(s)) positioned in the large notch on the back of the module (shown in FIGURE 4-17).
2. Depress the release trigger, and pull the module away from the **V 12**.



FIGURE 4-17

4.3 V Dock

The **V 12/V 21** V Dock is a physical mount for the monitor designed to provide a quick connection to a rolling stand (for the V 12) or to a wall mount (for the V 21). Before mounting to either of these peripheral devices, the V Dock must be mounted.

4.3.1 V Dock Mounting

1. Pick up the V Dock, and align the metal mounting plate on the bottom of the V Dock with the channel on the top of a wall mount (shown in FIGURE 4-19) or rolling stand (shown in FIGURE 4-20), with both the front and the back edges of the mounting plate beginning to slide sideways underneath the overhanging flanges of the mounting channel.

NOTE: The metal mounting plate is already affixed to the V Dock when it ships.

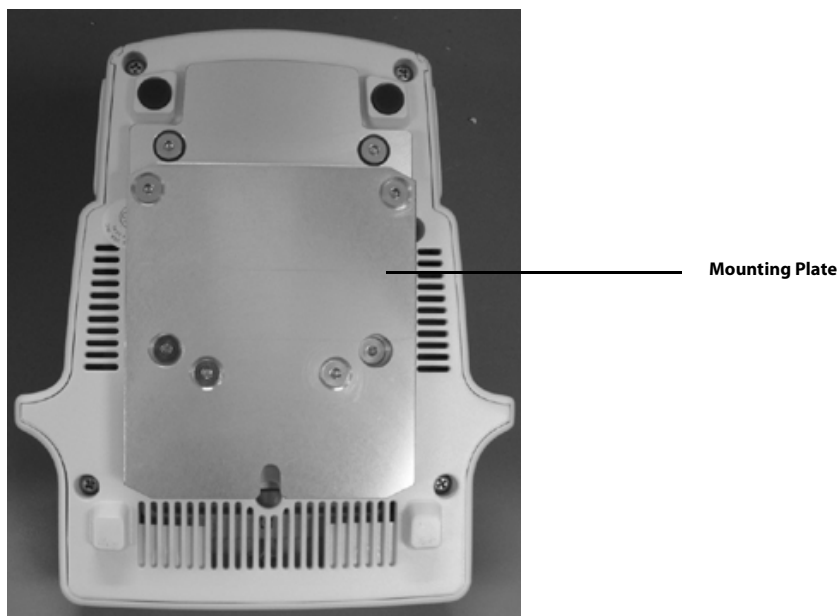

FIGURE 4-18 V Series Mounting Plate



FIGURE 4-19 V Series Wall Mount

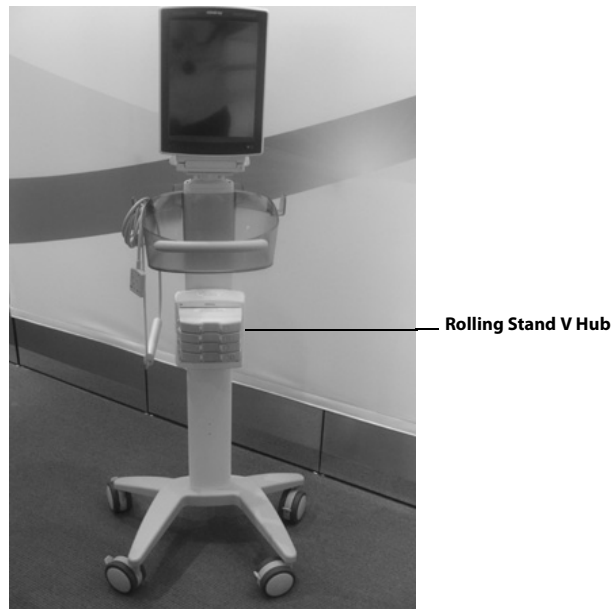

FIGURE 4-20 V Series Rolling Stand

2. Pull down on the spring-loaded plunger near the front of the mounting channel, and slide the V Dock sideways, ensuring that the front and back edges remain caught under the flanges of the channel.



FIGURE 4-21 Removal from Wall Mount



FIGURE 4-22 Removal from Rolling Stand

3. As the V Dock approaches a centered position relative to the wall mount (shown in FIGURE 4-21) or rolling stand (shown in FIGURE 4-22), release **V 21** the spring-loaded plunger. Continue to slide the V Dock sideways until the spring-loaded plunger engages the notch in the mounting plate, with a corresponding audible click.

4.3.2 V Dock Dismounting

1. If a **V 12** or **V 21** is docked, undock it.
2. Pull down on the spring-loaded plunger near the front of the mounting channel.
3. Firmly grip the V Dock with the other hand and carefully slide it sideways until it is free of the mounting channel.

4.4 V 21

4.4.1 V 21 Docking

NOTE: Mount the V Dock to the wall mount before attempting to mount the V 21. Refer to "V Dock" on page 4-12 for additional information.

CAUTION: The V 21 is intended for mounting only.

1. Hold the **V 21** by the side grips, or top handle, and vertically lower it onto the top of the V Dock, so that the alignment pins on the bottom of the **V 21** engage with the alignment channel on the top of the V Dock.

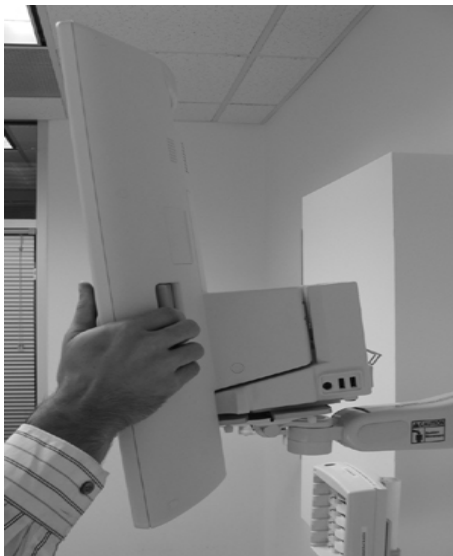

FIGURE 4-23



FIGURE 4-24

2. Push the **V 21** backward onto the V Dock, until the latch engages, with a corresponding audible click (shown in FIGURE 4-25).

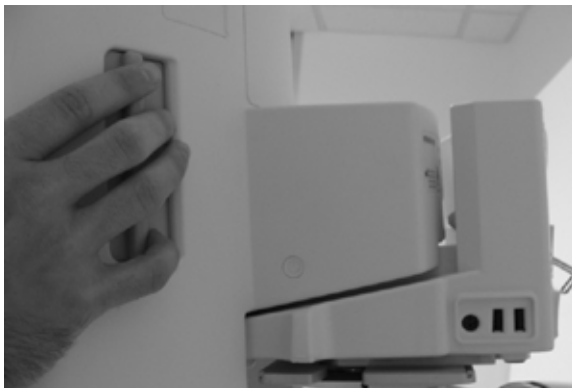

FIGURE 4-25

4.4.2 V 21 Undocking

1. Grab around both sides of the **V 21**, at the two side grip locations, with your palms firmly pressing against front edges of the **V 21**, and your fingers staged to grip the side actuators.



FIGURE 4-26

2. Close your grip against both actuators. The latch on the V Dock disengages, then the **V 21** pushes forward from the V Dock.
3. Lift the **V 21** up and away from the V Dock.



FIGURE 4-27

4.5 V Hub

4.5.1 V Hub Mounting

1. Pick up and hold the V Hub by gripping it around one or both sides, and align the channel in the mounting plate on the back of the V Hub with the cleat on a wall mount post, or on the front of a rolling stand, with both the left and the right flanges of the channel beginning to slide vertically over the flanges of the mounting cleat.



FIGURE 4-28 V Hub on a Wall Mount Post

2. Continue to slide the V Hub downward, ensuring that the flanges remain engaged, until the spring-loaded latch engages, with a corresponding audible click.

4.5.2 V Hub Dismounting

1. Grab the V Hub around both sides and, with the right hand, forcefully squeeze against the lever of the mounting plate on the back of the V Hub.
2. Carefully slide the V Hub upward until the mounting plate is free of the mounting cleat on the wall mount or rolling stand.

4.5.3 Module Installation

1. Look at the locked/unlocked indicator near the top left corner of the V Hub, and confirm that it is in the unlocked position (with green background). If not, then follow the instructions for Module Unlocking.
2. Pick up a module and align it with a group of module bays on the V Hub sufficient to accommodate the module. (For example, a VPS requires a set of three adjacent module bays.) Modules may be installed in either of two orientations (rotated 180° apart). Push the module inward until the module latch engages the latching pins on the V Hub, with a corresponding audible click. (Avoid pressing against any circular buttons on the end of the module, to avoid inadvertent actuation of the button function.)

4.5.4 Module Removal

1. Look at the locked/unlocked indicator near the top left corner of the V Hub, and confirm that it is in the unlocked position (with green background). If not, then follow the instructions for Module Unlocking.
2. Grip around the desired module with your thumb positioned against the module release trigger and your index finger (and/or other finger(s)) positioned in the large notch on the back of the module.



FIGURE 4-29

3. Depress the release trigger, and pull the module away from the V Hub.

4.5.5 Module Locking

- Insert the edge of a thin coin into the slot on the face of the lock on the bottom of the V Hub, and turn it clockwise, until the locked indicator appears. [This prevents any modules from being installed in or removed from all bays of the V Hub.]



FIGURE 4-30



FIGURE 4-31

4.5.6 Module Unlocking

- Insert the edge of a thin coin into the slot on the face of the lock on the bottom of the V Hub, and turn it counterclockwise, until the unlocked indicator (with green background) appears. [This allows modules to be installed in or removed from all bays of the V Hub.]



FIGURE 4-32



FIGURE 4-33

4.5.7 V Hub Status Indicators

The V Hub is connected to the **V 12/V 21** via cable. The indicator light at the base of the rack (shown in FIGURE 4-34) designates the status of the V Hub.

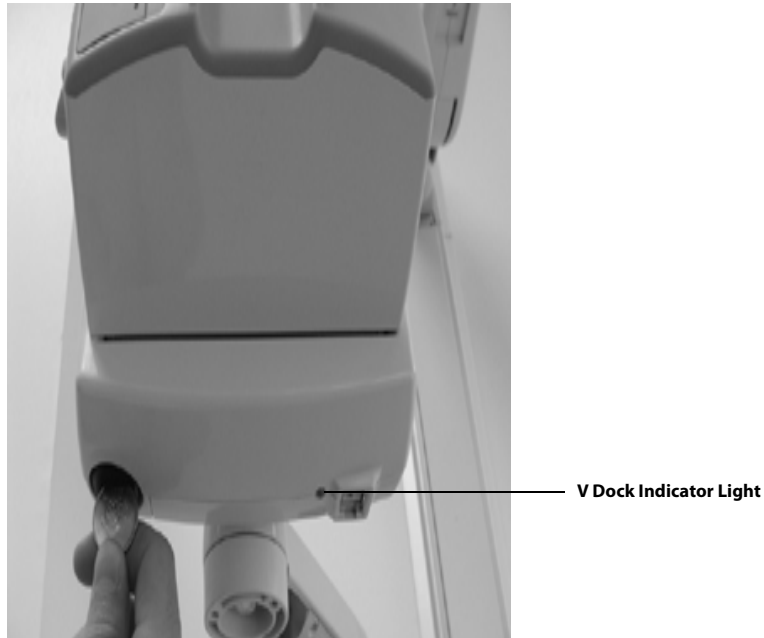

FIGURE 4-34

INDICATOR LIGHT COLOR	STATUS
No light	No communication, V Dock disconnected
Amber	Power on but V Hub is not communicating
Green	Power on and V Hub is communicating

4.5.8 Connecting the V Hub to the V 12/V 21

Connect the V Hub to the **V 12/V 21** using the interface cable shown in FIGURE 4-35. Mount the V Hub on a rolling stand (shown in FIGURE 4-20 on page 4-13) or to a wall mount (shown in FIGURE 4-29 on page 4-19).

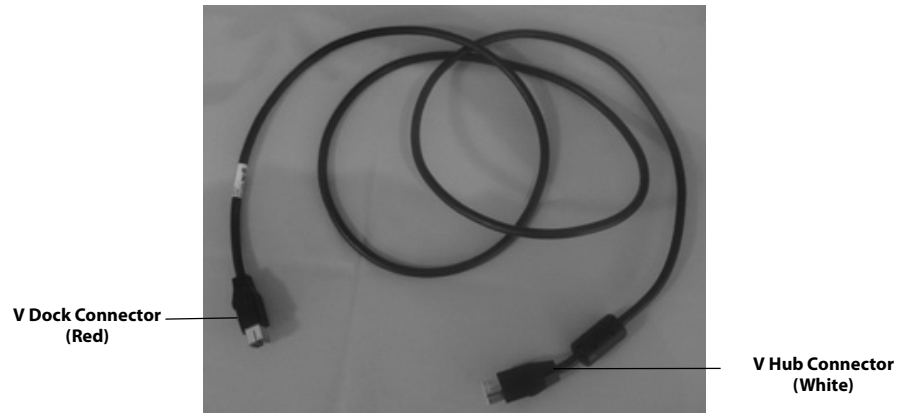

FIGURE 4-35 V Hub Interface Cable

NOTE: The interface cable red and white connectors are not interchangeable and must be inserted into the correct outlet. If they are not, the connector will not insert.

1. Insert the red connector of the interface cable into an available MR port (there are four MR ports) in the V Dock (shown in FIGURE 4-36).



FIGURE 4-36 V Dock Connector

2. Insert the white connector of the interface cable into the MR X (where X represents the port number) port in the V Hub (shown in FIGURE 4-37).

4.6 Rolling Stand

The rolling stand is designed specifically for the **V 12** monitor and is equipped with the following:

1. Mounting head with pivot
2. Storage bin
3. Locking casters
4. Mounting points for two (2) additional V Hubs
5. Cable routing hole and cable management guides

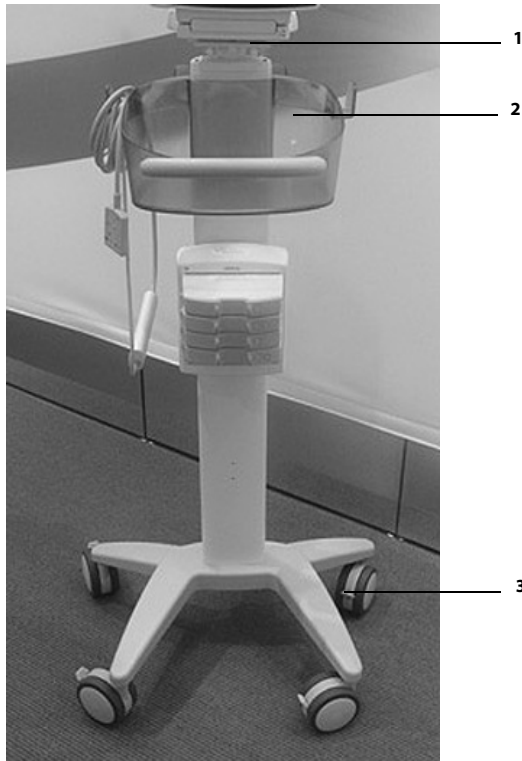

FIGURE 4-38



FIGURE 4-39 Pivot - Monitor pivots 360° around, forward, and backward

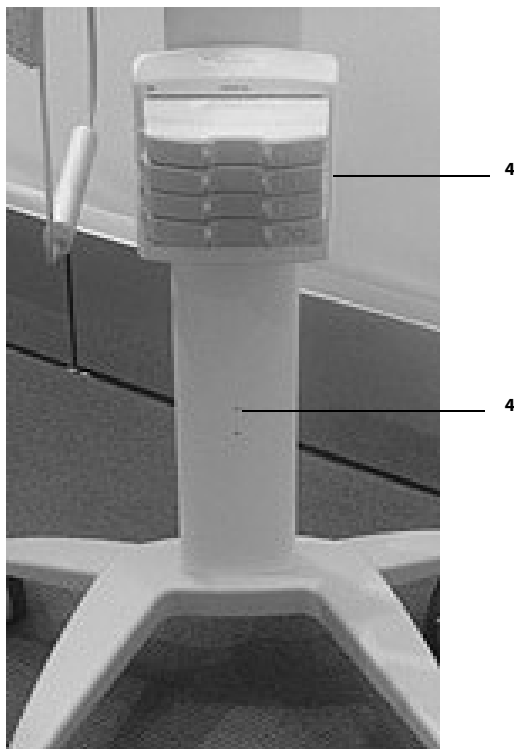

FIGURE 4-40

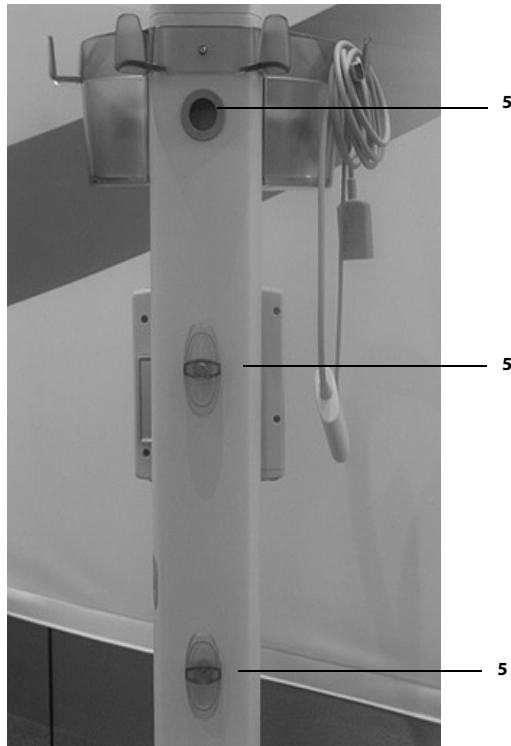

FIGURE 4-41

4.7 Thermal Recorder

4.7.1 Installing the Thermal Recorder Paper

1. Turn the recorder module upside down. Press the button to open the recorder door (as shown in FIGURE 4-42).



FIGURE 4-42

2. Locate the paper guides inside of the recorder (as shown in FIGURE 4-43).

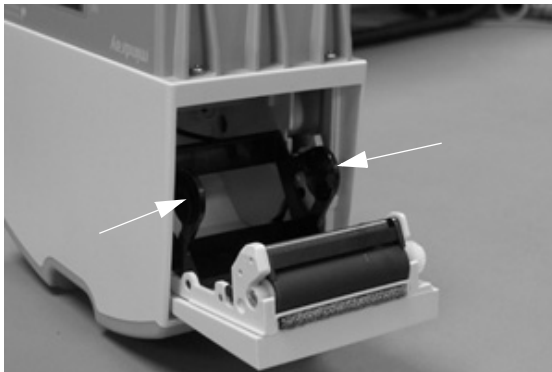

FIGURE 4-43

3. Place the thermal paper roll between the paper guides and gently press down until the paper is seated between the guides (as shown in FIGURE 4-44). Once installed, pull the paper to ensure it rolls out smoothly.

NOTE: Insert the paper with the shiny side facing upwards.

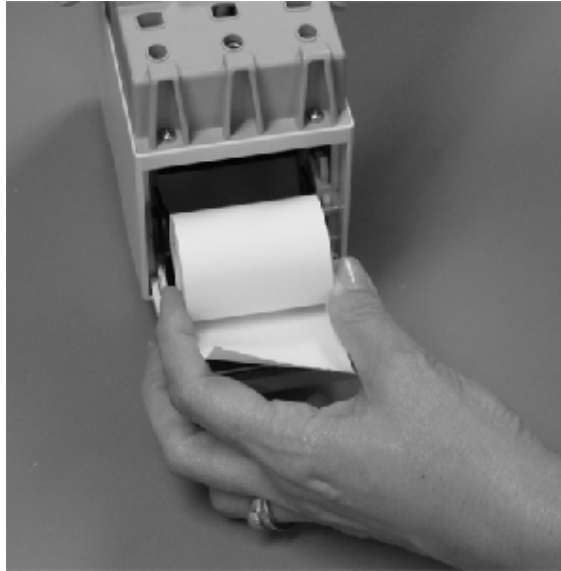

FIGURE 4-44

4. Close the recorder door (as shown in FIGURE 4-45).

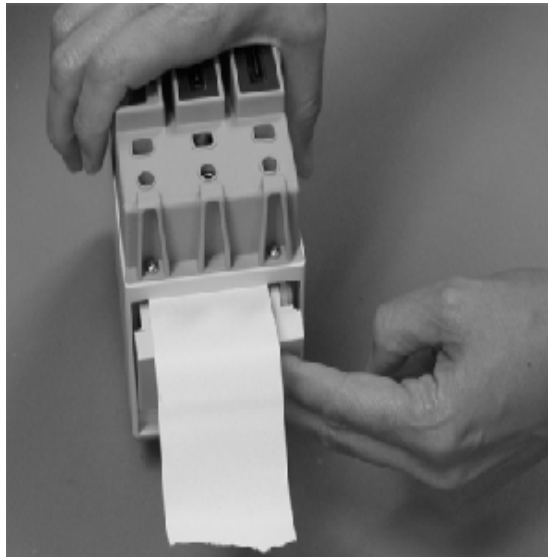

FIGURE 4-45

5. Optional - insert the recorder in the V Hub or Integrated V Hub.

4.8 Mechanical Functions Troubleshooting

MESSAGE/PROBLEM	REASON	SOLUTION
Recorder strips are blank	Paper was inserted incorrectly.	Reinsert paper with shiny side of paper facing upwards.
External V Hub is not functioning.	Cable from or to V Hub is kinked or not connected properly.	Remove kink in cable and/or re-seat cable.
	Cable is defective.	Try a different cable.
Internal V Hub (for V 12 only) is not functioning.	Inspect internal V Hub connectors to ensure that they intact and are not damaged.	If connectors are not intact, contact your System Administrator or Bio Medical engineer for assistance.
	Module may not be seated properly in bay.	Re-seat module to see if module indicator light illuminates.

* *Display messages are shown in bold text.*

This page intentionally left blank.

Module Configuration

Module Status Dialog.....	5-2
VPS Synchronization	5-6
Module Configuration Troubleshooting	5-8

5.1 Module Status Dialog

Depending on the patient's needs, different modules will need to be inserted and/or removed from the V Hubs (integrated or external). The **V 12** has an integrated V Hub that can hold up to three (3) 1x modules once the VPS (which is required) is inserted. The number of modules the V Hub can house depends on which modules are in use. For example, 1x modules occupy one V Hub position. The CO₂ module is a 2x module which occupies two V Hub positions. The VPS is a 3x module and occupies three positions in the V Hub.

NOTE: **The V 12/V 21 allows for a maximum of three racks, including the integrated rack in the V 12.**

CAUTION: **The V 12 only: A VPS should not be installed into a V Hub connected to a V Dock.**

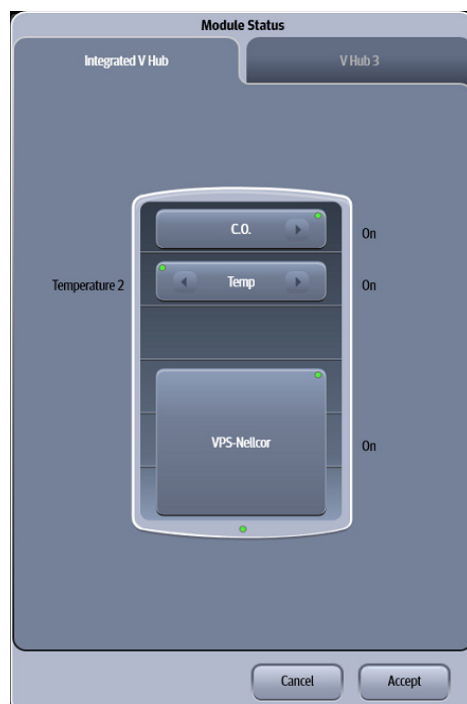

FIGURE 5-1 Example Module Status Dialog (configured Integrated V Hub and V Hub)

The Module Status dialog provides the following functionality:

- Current state of each V Hub
- Where each module is positioned in the V Hub

NOTE: **The order in which the modules display in the Module Status dialog is exactly how they are positioned in the V Hub.**



- Indicates whether an inserted module is functioning without error
- Provides ability to disable and enable a module
- Provides ability to view the assigned channel for an IBP and Temperature module.
- Provides ability to assign a channel to an IBP and Temperature module.

5.1.1 Navigating to the Module Status Dialog

1. Select the  icon in the upper right corner of the Main Screen to open the Module Status dialog (as shown in FIGURE 5-1).
2. If needed, select the **Integrated V Hub** or **V Hub x** (x represents the V Hub number) tab to find the needed module (as shown in FIGURE 5-1).
3. Ensure that all the modules needed indicate "On" beside the module identifier.



NOTE: A green light in the upper left corner of the module indicates the module is active and communicating.

5.1.2 Enabling/Disabling a Module

1. Select the  icon in the upper right corner of the Main Screen to open the Module Status dialog (as shown in FIGURE 5-1).
2. If needed, select the **Integrated V Hub** or **V Hub x** (x represents the V Hub number) tab to find the needed module (as shown in FIGURE 5-1).
3. Select the  icon beside the module name. A menu displays.
4. Select **On/Off** from the menu.
5. Select the **Accept** button.

NOTE: A green light in the upper left corner of the module indicates the module is active and communicating.

5.1.3 Changing an IBP or Temperature Module Channel

1. Select the  icon in the upper right corner of the Main Screen to open the Module Status dialog (as shown in FIGURE 5-1).
2. If needed, select the **Integrated V Hub** or **V Hub x** (x represents the V Hub number) tab to find the needed module (as shown in FIGURE 5-1).
3. Select the  arrow icon to display a list menu.
4. Select the desired channel.



NOTE: The channel number on the module changes when the channel number is selected in the Module Status dialog.

NOTE: If the message "You can't select multi same IBP channel or temperature channel." displays, this indicates that the selected channel is already in use.

5. Select the **Cancel** or **Accept** button.
 - The **Cancel** button closes the dialog without saving the settings.
 - The **Accept** button saves the settings and closes the dialog.

5.1.4 Changing VDI Modes

Currently, the VDI module interfaces with the Edwards Vigilance, Vigilance II, Vigileo, and EV1000 monitors, the Covidien INVOS monitor, the Gas Module 3, and with DIAP (Datascope Improved ASCII Protocol). Before using any of these external devices the VDI module must be properly configured.

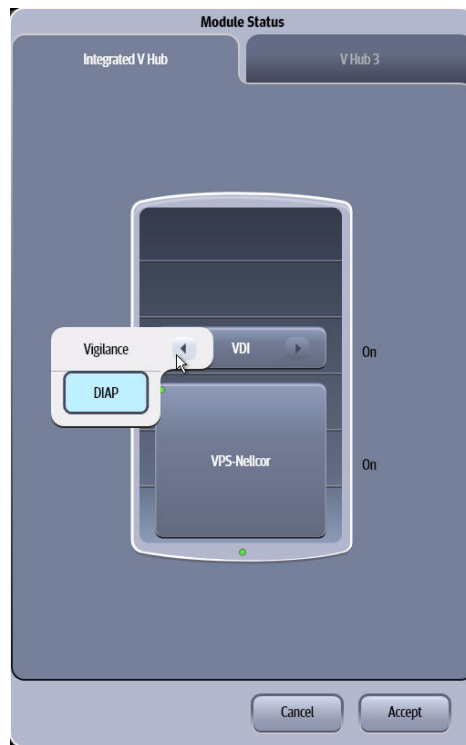



FIGURE 5-2 Module Status Dialog (with Integrated V Hub)

1. Select the  icon in the upper right corner of the Main Screen to open the Module Status dialog (as shown in FIGURE 5-2).
2. If needed, select the **Integrated V Hub** or **V Hub x** (x represents the V Hub number) tab to find the needed module.
3. Select the  arrow icon on the VDI module to display a list menu.
4. Select the desired mode (as shown in FIGURE 5-2).
5. Select the **Cancel** or **Accept** button.
 - The **Cancel** button closes the dialog without saving the settings.
 - The **Accept** button saves the settings and closes the dialog.

5.1.5 V 12/V 21 V Hub Module Limitations

The integrated and/or external V Hub houses the VPS and the additional modules for the **V 12/V 21** to monitor the patient parameters. TABLE 5-1 lists the number of V Hubs a monitor utilizes while monitoring a patient.

NOTE: Additional V Hubs may be physically connected, but only the maximum number listed in TABLE 5-1 will function.

TABLE 5-1

UNIT	MAXIMUM NUMBER OF ACTIVE V HUBS
V 12	2 external V Hubs, 1 integrated V Hub
V 21	3 external V Hubs

5.1.6 V 12/V 21 Module Limitations

There are limits to the number of modules and the types of modules an individual **V 12/V 21** may have in effect while monitoring a patient. TABLE 5-2 lists the maximum number of modules a monitor utilizes while monitoring a patient.

NOTE: Additional modules may be physically connected, but only the maximum number listed in TABLE 5-2 will function.

CAUTION: The V 12 only: A VPS should not be installed into a V Hub connected to a V Dock.

TABLE 5-2

UNIT	MAXIMUM NUMBER OF ACTIVE MODULES
VPS	1
Recorder	1
CO ₂	1
Temperature	2
CO	1
IBP	3
VDI	5 (2 can be DIAP, 1 Edwards, 1 Covidien INVOS monitor, 1 Gas Module 3)

NOTE: If an attempt is made to configure a fourth VDI module, the message, "Warning: Only three VDI modules can be re-configured at a time." displays. This message occurs whether the module is turned On or Off.

5.2 VPS Synchronization

The VPS is a device designed to acquire and store up to 12 hours of real-time vital sign data. This module can easily be moved with the patient between **V 12/V 21** displays without removing the patient connections. Whenever a VPS is removed from a monitor and inserted into another monitor, a VPS synchronization occurs. VPS synchronization ensures that the 12 hours of patient data and patient settings stored on the VPS and the monitor remain current.

5.2.1 VPS Synchronization: Mismatched Patient IDs

NOTE: The Patient ID described here is a unique identifier established when a patient is admitted. This ID cannot be changed and is not the same ID assigned by the clinician in the Patient Info Demographics tab. Refer to "Patient Demographics" on page 6-3 for additional information.

When a new patient VPS is inserted into a different monitor, the system recognizes that there is a patient ID mismatch. A patient ID mismatch indicates that the patient ID does not match the patient ID of the VPS. When this occurs, VPS synchronization is required before monitoring begins. A dialog (shown in FIGURE 5-3) providing three choices displays:

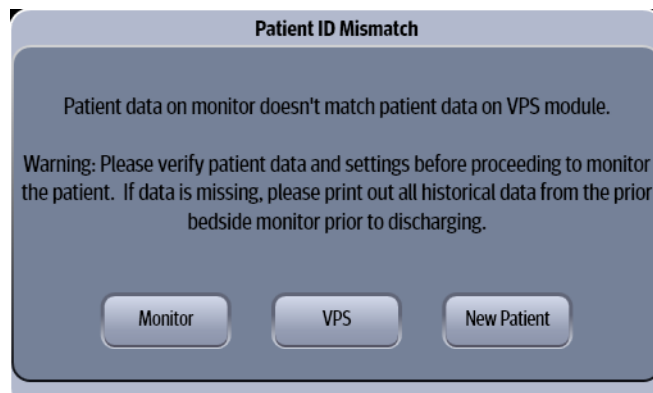

FIGURE 5-3 Patient ID Mismatch Dialog

Monitor

Selecting this button copies patient settings from the monitor to the VPS, and clears any previous data on VPS.

VPS

Selecting this button copies 12 hours of patient data and patient settings from the VPS to the monitor, and clears any previous data on the monitor.

New Patient

Selecting the **New Patient** button clears all previous patient data, patient settings contained on the monitor and the VPS, and all monitor display settings are reset to the departmental defaults.

5.2.2 VPS Synchronization: Same Patient IDs

When the same patient VPS is inserted into the same monitor (no patient mismatch ID present), a VPS synchronization is still required to ensure that the data is current. Once the VPS is inserted, several messages display in the System Status (upper portion of display) message area. The Confirmation Dialog (shown in FIGURE 5-4) also displays prompting for a response. Select the **OK** button to continue.

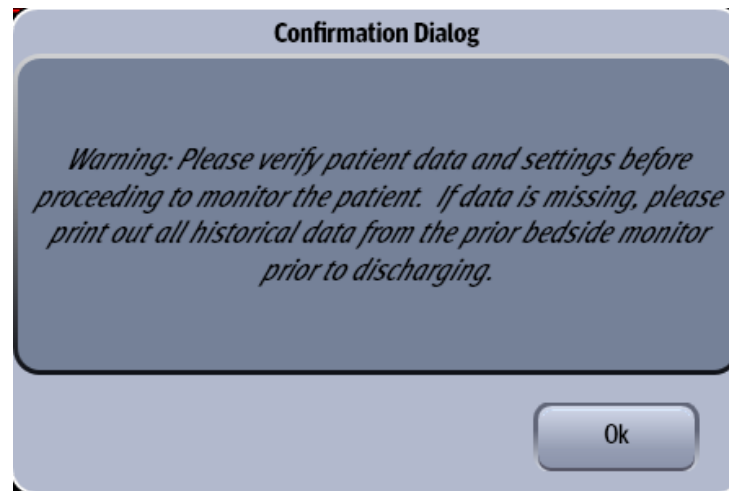

FIGURE 5-4 VPS Confirmation Dialog

5.2.3 VPS Synchronization Failures

There are three types of VPS Synchronization failures.

5.2.3.1 Hard Failure

This is the most serious of synchronization failures and indicates that no data is being written to the VPS. The **V 12/V 21** continues to monitor and saves the patient data to the monitor's hard drive, but not to the transferable VPS module. When this failure occurs, a **VPS Storage Failure** message displays in the System Status message area. A confirmation dialog also displays with the following message: **Warning: No data is being stored to or retrieved from the VPS. Switch to another VPS to restore data storage.**

5.2.3.2 Export Failure

This synchronization failure indicates that more than 10 seconds of historical data was not saved to the VPS. To ensure that all patient data is seen, print the historical data from the bedside monitor before the patient is discharged. When an export failure occurs, a confirmation dialog displays with the following message: **Warning: More than 10 seconds of historical data has not been saved to the VPS. Please print out all historical data from the bedside monitor prior to discharging message displays.**

5.2.3.3 Import Failure

This is a general confirmation message (shown in FIGURE 5-4) to verify the patient data and settings before monitoring begins.

5.3 Module Configuration Troubleshooting

MESSAGE/PROBLEM	REASON	SOLUTION
You can't select multi same IBP channel or temperature channel.	Cannot use the same label twice.	Change the channel label to one not currently in use.
Module indicator light is amber	Module is only partially seated in V Hub.	Remove module and insert again with more force.
	VPS is not installed and must be for other modules to function.	Insert VPS into V Hub.
	Module is resetting or was just inserted.	Wait until indicator light displays green.
	Maximum number of modules was exceeded.	Refer to TABLE 5-2 on page 5-5 to determine if the maximum number of modules was exceeded.
External V Hub is not functioning.	Cable from or to V Hub is kinked or not connected properly.	Remove kink in cable and/or re-seat cable.
Internal V Hub (for V 12 only) is not functioning.	Inspect internal V Hub connectors to ensure that they intact and are not damaged.	If connectors are not intact, contact your System Administrator or Bio Medical engineer for assistance.
	Module may not be seated properly in bay.	Re-seat module to see if module indicator light illuminates.
VPS Storage Failure	VPS is damaged.	Replace VPS.
Patient ID Mismatch dialog displays	System identified a patient ID mismatch.	Refer to "VPS Synchronization: Mismatched Patient IDs" on page 5-6 for additional information.

6.0

Patient Management

Introduction	6-2
Patient Info Dialog.....	6-2
Patient Management Troubleshooting	6-8

6.1 Introduction

The **V 12/V 21** comes with default factory settings which enable a clinician to begin monitoring without setting any of the waveforms, parameters, alarms, or functions. However, all of these settings can be changed for specific patient or departmental needs.

NOTE: Certain operating characteristics are based on the selected patient size (e.g. NIBP start pressure). Match the patient size selection to the actual patient before monitoring begins.

6.2 Patient Info Dialog

The Patient Info dialog (as shown in FIGURE 6-1) contains a **Demographics** tab, **Room/Bed** tab, and a **Transfer/Discharge** tab. A description of each tab follows.

6.2.1 Navigating to the Patient Info Dialog

1. Select the Header Bar (located above the top waveform).
The Patient Info dialog displays (as shown in FIGURE 6-1).

OR

2. Select the **Setup** tab from the Navigation Area.
3. Select the **Patient Info** button.
The Patient Info dialog displays (as shown in FIGURE 6-1).

The screenshot shows the 'Patient Info' dialog box with the 'Demographics' tab selected. The dialog has three tabs: 'Demographics', 'Room / Bed', and 'Transfer / Discharge'. The 'Demographics' tab contains the following fields and values:

Field	Value
Patient Size	Adult
ID	
Last Name	
First Name	
Gender	Unspecified
Race	Undefined
Height	Unspecified
Weight	Unspecified
Date of Birth	
Year	
Month	
Day	
Age	

At the bottom of the dialog are three buttons: 'Standby', 'Cancel', and 'Accept'.

FIGURE 6-1 Example Patient Info Dialog (Demographics Tab)

6.2.2 Admitting a Patient

NOTE: When connected to a central monitoring system (i.e., central station), a patient admission at the V 12/V 21 bedside monitor also admits the patient to the central station. Refer to the central station operating instructions for additional information.

1. Turn the monitor on using the **ON/OFF** switch located on the lower right of the monitor.

NOTE: Refer to "V 12/V 21 Physical Views" on page 1-5 for additional information and location of ON/OFF switch.

NOTE: Remove the previous patient's data by discharging the patient before admitting the new patient. Refer to "Discharging a Patient" on page 6-5 for additional information.

2. Connect the patient to the monitor and apply the appropriate accessories such as ECG electrodes, blood pressure cuff, etc.

6.2.3 Patient Demographics

To enter or edit patient information after admission in the **Demographics** tab.

1. Select the Header Bar (located above the top waveform) to display the Patient Info dialog. By default, the **Demographics** tab is selected.
2. Select the applicable button to begin entering or editing. Refer to TABLE 6-1 for a description of each button.

NOTE: Refer to the Chapter 2.0 Getting Started section for specific instructions on how to use the keyboards, keypads, etc.

NOTE: When connected to a central monitoring system (i.e., central station), the following fields are updated at the central station whenever they are entered or edited at the V 12/V 21 bedside monitor: Patient Size, ID, Bed, Year, Month, Day (date of birth), Gender, and Height. Refer to the central station operating instructions for additional information.

TABLE 6-1

BUTTON	SELECTIONS	COMMENTS
Patient Size	Adult	Select to enter the patient size.
	Pediatric	Verify monitoring settings when the patient size is changed.
	Neonate	
NOTE:	The selected patient size remains after power down and discharge.	
NOTE:	A confirmation dialog displays if you change patient size. Verify monitoring settings when the patient size is changed.	
ID	None	Select to enter or change Patient ID. Accepts up to 15 alphanumeric characters. Factory default is a blank value.
Last Name	None	Select to enter or change patient's last name. Accepts up to 15 alphabetic characters. Factory default is a blank value.
First Name	None	Select to enter or change patient's first name. Accepts up to 15 alphabetic characters. Factory default is a blank value.

* Default values display in bold.

TABLE 6-1 (Continued)

BUTTON	SELECTIONS	COMMENTS
Gender	Unspecified Male Female	Select to enter or change patient gender.
Race	Caucasian Asian Black Other Undefined	Select to enter or change patient race.
Height	Unspecified	Select to enter or change patient's height. Factory default is a blank value.
Weight	Unspecified	Select to enter or change patient weight. Factory default is a blank value.
Year	None	Select to enter or change the patient's year of birth. Factory default is a blank value.
Month	None	Select to enter or change the patient's month of birth. Factory default is a blank value.
Day	None	Select to enter or change the patient's date of birth. Factory default is a blank value.
Age	None	Auto calculate and display the patient's age according to the patient's date of birth.

* *Default values display in bold.*

3. Select the **Cancel** or **Accept** button.
 - The **Cancel** button closes the dialog without saving the settings.
 - The **Accept** button saves the settings and closes the dialog.

6.2.4 Patient Room and Bed

Enter or edit the patient's location information using the buttons in the **Room/Bed** tab.

NOTE: Refer to the **Chapter 2.0 Getting Started for specific instructions on how to use the keyboards, keypads, etc.**

1. Select the Header Bar (located above the top waveform).
The Patient Info dialog displays.
2. Select the **Room/Bed** tab (as shown in FIGURE 6-2).

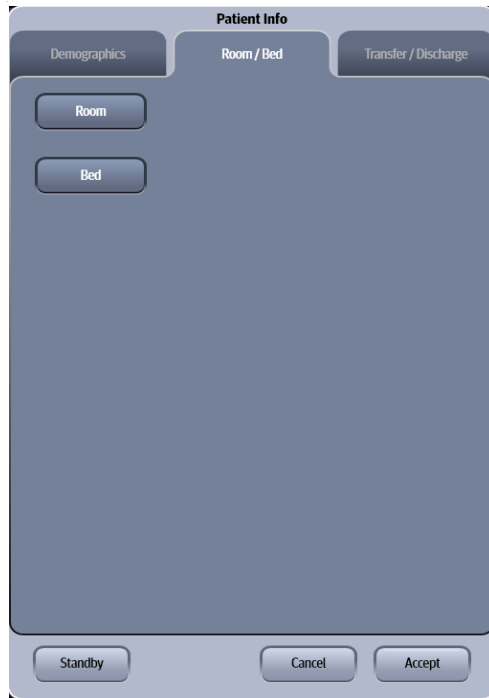

FIGURE 6-2 Example Patient Info Dialog (Room/Bed Tab)

3. Select the applicable button to begin entering or editing. Refer to TABLE 6-2 for a description of each button.

TABLE 6-2

BUTTON	SELECTIONS	COMMENTS
Room	None	Select to enter the patient's alphanumeric room number. Factory default is a blank value.
Bed	None	Select to enter the patient's alpha digital bed number. Factory default is a blank value.

4. Select the **Cancel** or **Accept** button.
 - The **Cancel** button closes the dialog without saving the settings.
 - The **Accept** button saves the settings and closes the dialog.

6.2.5 Discharging a Patient

Discontinue monitoring a patient by discharging them from the monitor. Discharging a patient clears all their historical data from the monitor.

NOTE: When connected to a central monitoring system (i.e., central station), a patient's discharge from the V 12/V 21 bedside monitor also discharges the patient from the central station. Refer to the central station operating instructions for additional information.

NOTE: Switching leadsets or discharging a patient automatically reverts the ST Dialog Representative Beat Display setting to the default of Auto.

1. Select the Header Bar (located above the top waveform).
The Patient Info dialog displays.
2. Select the **Transfer/Discharge** tab (as shown in FIGURE 6-3).

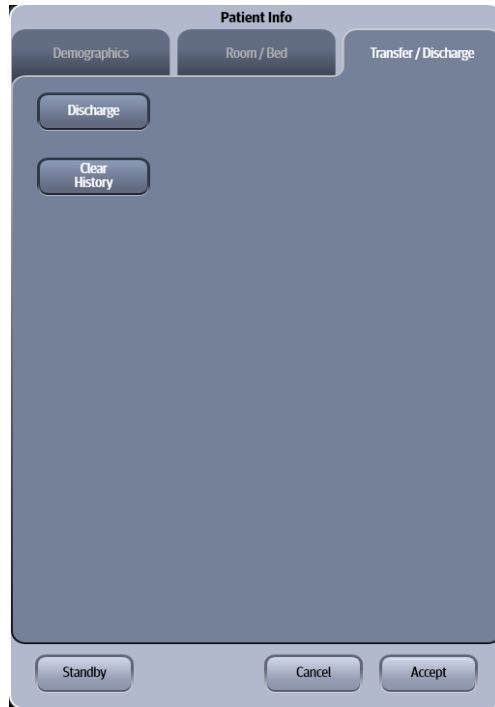

FIGURE 6-3 Example Patient Info (Transfer/Discharge Tab)

3. Select **Discharge**. A confirmation dialog displays the message **Are you sure you want to discharge? This will restore the defaults for all settings and clear history data.**
4. Select **No** or **Yes**.
 - Selecting **No** cancels the operation.
 - Selecting **Yes** does the following:
 - Returns to the Discharge dialog
 - Discharge occurs at the local monitor and the central station (if applicable).
 - All patient data and trends are cleared.
 - Default departmental settings are restored.

6.2.6 Clearing Patient History

To clear a patient's history without discharging them from the monitor:

1. Select the Header Bar (located above the top waveform).
The Patient Info dialog displays.
2. Select the **Transfer/Discharge** tab, then select the **Clear History** button.
3. A confirmation dialog displays the message **Are you sure you want to clear the history data of this patient?**
4. Select **No** or **Yes**.

6.2.7 Placing a Patient in Standby

NOTE: When connected to a central monitoring system (i.e., central station), and a patient is moved or removed from standby at the V 12/V 21 bedside monitor, the patient is moved or removed from standby at the central station. Refer to the central station operating instructions for additional information.

To enter the standby mode:

1. Select the Header Bar (located above the top waveform).
The Patient Info dialog displays.
2. Select the **Transfer/Discharge** tab, then select the **Standby** button.

Placing a patient in the standby mode does the following:

- Temporarily suspends patient monitoring
- Places alarms in permanent suspension
- Places interval NIBP measurements in Pause mode
- Shuts off the CO₂ pump
- Removes all patient data from the screen and displays **standby mode** on the display

6.2.8 Exiting the Standby Mode

- To exit the standby mode, select the touch screen. When in the standby mode, the message **Touch screen to resume monitoring** displays.

When exiting from the standby mode to the monitoring mode, the monitor responds as follows:

- Restores parameter measurement as previously configured.
- Arrhythmia automatically relearns.
- NIBP measurement **does not** automatically start. Restart NIBP measurements via the **Start** button.
- Restores normal data storage.
- The CO₂ pump automatically reactivates provided the sensor is in place.
- All the alarms are activated.
- The display settings are maintained during standby mode.
- The monitor notifies the central station and other monitors when back in monitoring mode.

6.3 Patient Management Troubleshooting

MESSAGE/PROBLEM	REASON	SOLUTION
The Month and Day buttons are disabled in the Patient Info dialog.	The birth year needs to be entered first.	Select the Year button to enter the birth year, then the Month button enables once entered, followed by the Day button.
The entered string is invalid.	Only alpha characters may be entered.	Use the Delete key in the keyboard dialog to remove the invalid character(s), then reenter.
Units in weight keypad are set to kg.	The kg key is selected in the keypad.	Select the lb key in the keypad to change units to pounds, then select the Enter key.
Units in height keypad are set to cm.	The cm key is selected in the keypad.	Select the inch key in the keypad to change units to inches, then select the Enter key.
Value out of range	An invalid value was entered in the keypad.	The acceptable range displays above the text box. Observe the range, then enter a value within the range.

* *Display messages are shown in bold text.*

7.0

Alarm Behavior

General Alarm Behavior	7-2
Physiological Alarms	7-2
Technical Alarms	7-4

7.1 General Alarm Behavior

The **V 12/V 21** uses alarms to send notification when a patient's physiological status changes, a patient has a specific technical issue, or when there is a system violation. When a patient is first admitted, the default system alarm settings are in effect. Modify individual patient alarm settings by using the **Alarms** tab in the individual parameter dialogs. By default, alarm settings send notification using:

- Visual indicators
- Audible indicators

The three alarm types used in this system include physiological, technical, and system.

7.2 Physiological Alarms

Physiological alarms indicate a violation of a monitored patient's physiological alarm thresholds or arrhythmia analysis settings.

NOTE: Refer to "Alarms" on page 8-2 for additional information.

7.2.1 Alarm Behaviors

The visual and audio indicators associated with a physiological alarm are:

Visual Indicators

Visual indicators provide visual notification when an alarm threshold is violated. When a physiological alarm condition is triggered, the digital data portion of the patient tile flashes (if the alarm priority is set to high or medium), a text message displays in the digital tile, and, if configured, the alarm light indicators flash, unless it is a low level alarm, in the corresponding alarm response color. The physiological alarm behavior varies depending on the parameter, and on the alarm priority associated with the parameter.

Audio Indicators

Audio indicators provide audible notification when an alarm threshold is violated. Audio indicators may vary depending on the alarm severity, alarm type, system setup and configuration. Audio alarms are triggered by:

- The onset of an alarm condition, provided the alarm delay is not active.
- A configured alarm delay, if alarm delay is active.

Once the alarm condition is resolved and/or silenced, the audible alarm stops, unless the alarm is latched.

7.2.2 Alarm Options

The alarm options associated with a parameter dictate how the system responds when an alarm occurs.

Latching

Alarm **latching** denotes that the audio and visual indicators, associated with an alarm condition, do not automatically stop after resolving the patient alarm condition. After resolving the condition, it must be acknowledged or the audio and visual alarm indicators continue.

The Navigator Area's **Silence** button temporarily silences the alarm condition for the configured time period. However, if that latched alarm is not acknowledged during the configured time period, the alarm indicators resume.

To acknowledge a latched alarm condition, once the condition is resolved, select the **Silence** or **Silence All** button from the Navigator Area.

Apnea Latching

The conditions for apnea latching follow standard latching procedures, however apnea latching is associated with an apnea alarm condition. This option can be enabled/disabled in the Respiration dialog's **Apnea** tab. The apnea latching factory default setting is Off.

NOTE: Refer to "Configuring Apnea Alarms" on page 10-5 for additional information.

Audio Alarm Delay

Audio Alarm Delay is the configurable time period required before an alarm sound triggers. Alarm Audio Delay does not effect the Apnea Alarm, ST Alarms, the non-lethal arrhythmia alarms, or the lethal arrhythmia alarms. When permitted, this option can be enabled/disabled in the **Alarm Setup** dialog.

7.2.3 Physiological Alarm Responses

The alarm responses associated with a physiological alarm are as follows:

7.2.3.1 Alarm Levels

The **V 12/V 21** supports three alarm levels. When an alarm level is turned on, the choices available are high, medium, and low. Alarms may be turned off by selecting the **All Off** button in the respective parameter dialog's **Alarms** tab. Alarm priorities associated with lethal alarms cannot be changed from their default value of high. However, all other parameters can be modified. The alarm level used to configure a parameter defines the alarm severity.

When a parameter's alarm level is turned off, there are no visual or audio alarm indicators associated with the alarm event, however Nurse Call is still available if it was enabled in the System setup.

NOTE: Refer to "Configuring the General Tab" on page 25-3 for more information about Nurse Call.

High Level Alarms

High level alarms are the most severe alarm type. Lethal-arrhythmia alarms (for example, Asystole, V-Tach, and V-Fib) are automatically configured as high level alarms and cannot be modified. High level alarm conditions cause the applicable parameter digital tile to flash in red, display a red text message in the parameter tile message area, use a high level alarm sound, and if configured, the alarm light indicator flashes in the corresponding alarm response color. A parameters' alarm limit is configured in the respective parameter dialog's **Alarms** tab.

Medium Level Alarms

Medium level alarms are less severe than high level alarms, and have different visual and audio indicators. Medium level alarm conditions cause the applicable parameter digital tile to flash in yellow (for a physiological alarm), display a yellow text message in the parameter tile message area (if alarm delay is not enabled), use a low level alarm sound, and if configured, the alarm light indicator flashes in the corresponding alarm response color. A parameters' alarm limit is configured in the respective parameter dialog's **Alarms** tab.

Low Level Alarms

Low level alarms are the least severe of the three alarm levels. Low level alarm conditions cause the applicable parameter digital tile numeric to display in blue (for a physiological alarm), display a blue text message in the parameter tile message area (if alarm delay is not enabled), use a low level alarm sound, and if configured, the alarm light indicator displays the corresponding alarm response color. A parameters' alarm limit is configured in the respective parameter dialog's **Alarms** tab.

All Off

Any alarm levels can be turned off, including lethal alarms. Parameters configured to use All Off do not have any visual or audio alarm indicators, however, Nurse Call still functions.

7.3 Technical Alarms

Technical alarms are patient specific and are related to technical issues. Due to their potential severity if left unattended, some technical alarms behave as physiological alarms by enunciating and flashing in the chosen alarm priority color. The GM3 Disconnect and Low Battery technical alarms are examples of this.

7.3.1 Alarm Behaviors

The visual and audio indicators associated with a technical alarm are as follows:

Visual Indicators

Technical visual indicators display as white text messages in the parameter tile's message area.

Audio Indicators

Technical alarm sounds are unique to other alarm types.

Alarms

Alarms	8-2
Alarm Limits	8-2
Alarm Responses	8-12
Arrhythmia Alarms	8-16
Alarm Setup	8-20
Alarms Troubleshooting	8-21

8.1 Alarms

This chapter discusses how to configure alarms through the **Alarms** tab. The choices are **Limits**, **Responses**, **Arrhythmia**, and **Alarm Setup**. A description of each tab follows.

8.1.1 Navigating to the Alarms Dialogs

1. Select the **Alarms** tab from the Navigation Area.
2. Select one of the buttons to access the respective alarm dialog.

8.2 Alarm Limits

Use the Alarm Limits dialog to set the parameter's high and low alarm limit thresholds. Alarms are triggered when the alarm limit is equal to or exceeds the high or low configured alarm limit for the parameter. The steps to configure a parameters alarm limits is the same for all parameters and is described in the following section.

The Alarm Limits dialog contains the following tabs: **ECG/Resp**, **Pressure**, **Temp**, **Gases**, **CCO/Hemo**, and **Oximetry**. A description of each tab follows.

8.2.1 Configuring Alarm Limits

NOTE: When connected to a central monitoring system (i.e., central station), entered or edited alarm limits made at the V 12/V 21 are transferred to the central station. Refer to the central station operating instructions for additional information.

To access the alarm limits dialog from any parameter tile:

1. Select the respective parameter tile to open the parameter dialog.
2. Select the **Alarms** tab.
An alarm limits dialog displays similar to FIGURE 8-1.

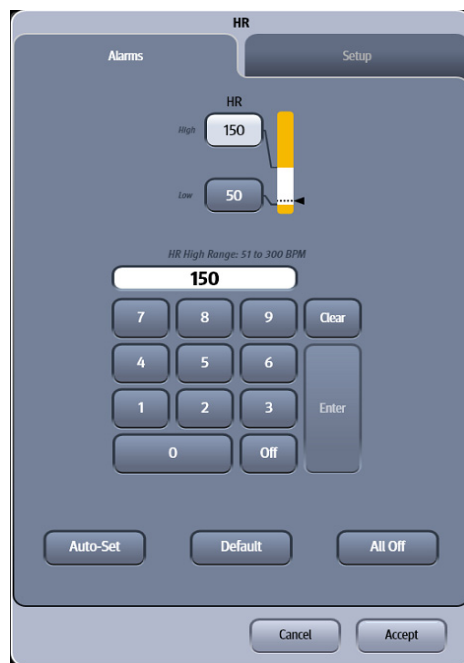

FIGURE 8-1 Example HR Alarm Limits Dialog

3. Select the high or low alarm limit button or select the Auto-Set button.

NOTE: When first entering the dialog, the high limit is selected.

NOTE: Refer to "Auto-Set All Alarms Button" on page 8-10 for additional information.

NOTE: Before setting the alarm limits, refer to "Factory Default Alarm Limits" on page 8-4 for additional information.

4. Use the keypad to enter the high and low alarm limit button or select **Off** using the keypad. TABLE 8-1 describes the keypad button. The **Enter** key changes to green after a value is entered.

NOTE: The alarm limit range is indicated in italics above the alarm limit text box.

TABLE 8-1

BUTTON	DESCRIPTION
Clear	Erases the keypad entry.
Enter	Accepts the keypad entry.
Auto-Set	Auto configures the parameter alarm limit high and low values based on the individual parameter specifications.
Default	Auto configures all the parameter's limits to the departmental defaults.
All Off	Turns off all the parameter's alarm limits.

5. Select the **Enter** key to save the alarm limit.

NOTE: The pop-up message "Value out of range" displays if the entered alarm limit is outside the alarm limit range.

6. Select the **Cancel** or **Accept** button.
 - The **Cancel** button closes the dialog without saving the settings.
 - The **Accept** button saves the settings and closes the dialog.

To access the alarm limits dialog from the Navigation Area:

1. Select the **Alarms** tab from the Navigation Area.
2. Select the **Limits** button.
The Alarm Limits dialog displays (as shown in FIGURE 8-2).

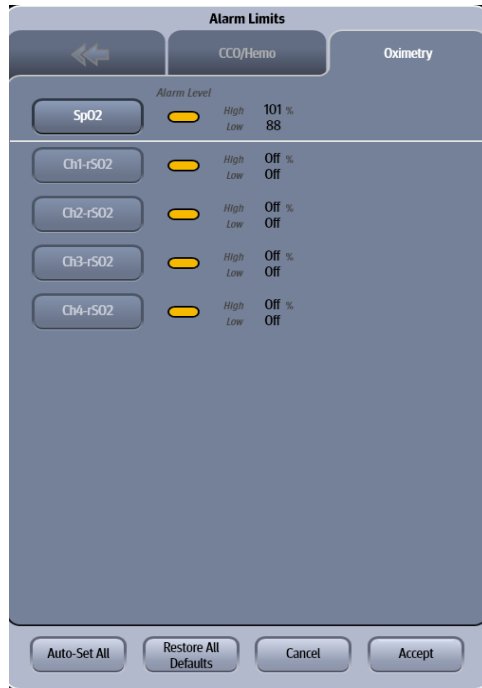

FIGURE 8-2 Example Alarm Limits Dialog (Oximetry Tab)

3. Select the applicable alarm group tab. For example, to change the NIBP alarm limits, select the Pressure tab.
4. Select applicable parameter button to set the alarm limits for the individual parameter.
5. Follow steps 3 through 6 in the "Configuring Alarm Limits" on page 8-2.

8.2.2 Factory Default Alarm Limits

8.2.2.1 ECG/Resp Tab

TABLE 8-2 lists the alarm limit ranges for the parameters contained in the **ECG/Resp** tab.

TABLE 8-2

PARAMETER	ALARM LIMIT	ADULT	PEDIATRIC	NEONATE
HR Unit of Measure: bpm Resolution: 1 bpm Invalid data: "-"	High Limit	Off, 50 to 300 Default other: 150 Default France: 120	Off, 50 to 300 Default other: 180 Default France: 150	Off, 50 to 350 Default other: 200 Default France: 175
	Low Limit	Off, 25 to 200 Default other: 50 Default France: 30	Off, 25 to 200 Default other: 80 Default France: 50	Off, 25 to 200 Default other: 90 Default France: 70
NOTE: When the V 12/V 21 language is configured to French, the Heart Rate (HR) high/low alarm limit cannot be turned Off.				

TABLE 8-2

PARAMETER	ALARM LIMIT	ADULT	PEDIATRIC	NEONATE
ST Single Unit of Measure: mm Resolution: 0.1mm Invalid data: "-"	High Limit	Off, 0.5 to 10 Default: Off	Off, 0.5 to 10 Default: Off	N/A
	Low Limit	Off, -10.0 to -0.5 Default: Off	Off, -10.0 to -0.5 Default: Off	N/A
ST Dual Unit of Measure: mm Resolution: 0.1mm Invalid data: "-"	High Limit	Off, 0.5 to 10 Default: Off	Off, 0.5 to 10 Default: Off	N/A
	Low Limit	Off, -10 to -0.5 Default: Off	Off, -10 to -0.5 Default: Off	N/A
Resp Unit of Measure: RPM Resolution: 1RPM Invalid data: "-"	High Limit	Off, 10 to 190 Default: Off	Off, 10 to 190 Default: Off	Off, 10 to 190 Default: Off
	Low Limit	Off, 5 to 50 Default: Off	Off, 5 to 50 Default: Off	Off, 5 to 50 Default: Off
Apnea Alarm	NOTE:	Refer to "Configuring Apnea Alarms" on page 10-5 for additional information.		
Apnea Latch				
Apnea Delay Unit of Measure: seconds Resolution: 1second	N/A	10 to 60 Default: 30	10 to 20 Default: 15	10 to 20 Default: 15

8.2.2.2 Pressure Tab

TABLE 8-3 lists the alarm limit ranges for the parameters contained in the **Pressure** tab.

TABLE 8-3

PARAMETER	ALARM LIMIT	ADULT	PEDIATRIC	NEONATE
NIBP Unit of Measure: mmHg Resolution: 1 mmHg Invalid data: "-"	High Systolic Limit	Off, 40 to 240 Default: Off	Off, 30 to 140 Default: Off	Off, 30 to 100 Default: Off
	Low Systolic Limit	Off, 30 to 150 Default: Off	Off, 20 to 120 Default: Off	Off, 20 to 90 Default: Off
	High Diastolic	Off, 40 to 150 Default: Off	Off, 30 to 120 Default: Off	Off, 30 to 90 Default: Off

TABLE 8-3

PARAMETER	ALARM LIMIT	ADULT	PEDIATRIC	NEONATE
	Low Diastolic	Off, 20 to 140 Default: Off	Off, 20 to 100 Default: Off	Off, 10 to 80 Default: Off
	High Mean	Off, 60 to 200 Default: Off	Off, 30 to 140 Default: Off	Off, 30 to 90 Default: Off
	Low Mean	Off, 20 to 150 Default: Off	Off, 20 to 100 Default: Off	Off, 10 to 70 Default: Off
IBP 1-8 Unit of Measure: mmHg Resolution: 1 mmHg Invalid data: "-"	High Systolic Limit	Off, 5 to 300 Default: Off	Off, 5 to 300 Default: Off	Off, 5 to 300 Default: Off
	Low Systolic Limit	Off, 0 to 150 Default: Off	Off, 0 to 150 Default: Off	Off, 0 to 150 Default: Off
	High Diastolic	Off, 5 to 200 Default: Off	Off, 5 to 200 Default: Off	Off, 5 to 200 Default: Off
	Low Diastolic	Off, 0 to 150 Default: Off	Off, 0 to 150 Default: Off	Off, 0 to 150 Default: Off
	High Mean	Off, 5 to 200 Default: Off	Off, 5 to 200 Default: Off	Off, 5 to 200 Default: Off
	Low Mean	Off, 0 to 150 Default: Off	Off, 0 to 150 Default: Off	Off, 0 to 150 Default: Off

8.2.2.3 Temp Tab

TABLE 8-4 lists the alarm limit ranges for the parameters contained in the **Temp** tab.

TABLE 8-4

PARAMETER	ALARM LIMIT	ADULT	PEDIATRIC	NEONATE
Temperature (T1-T3) Unit of Measure: °F Resolution: 0.1 °F Invalid data: "-"	High Limit	Off, 77.0 to 113.0 Default: Off	Off, 77.0 to 113.0 Default: Off	Off, 77.0 to 113.0 Default: Off
	Low Limit	Off, 59.0 to 104.0 Default: Off	Off, 59.0 to 104.0 Default: Off	Off, 59.0 to 104.0 Default: Off

TABLE 8-4

PARAMETER	ALARM LIMIT	ADULT	PEDIATRIC	NEONATE
Temperature (T1-T3) Unit of Measure: °C Resolution: 0.1 °C Invalid data: "--"	High Limit	Off, 25.0 to 45.0 Default: Off	Off, 25.0 to 45.0 Default: Off	Off, 25.0 to 45.0 Default: Off
	Low Limit	Off, 15.0 to 40.0 Default: Off	Off, 15.0 to 40.0 Default: Off	Off, 15.0 to 40.0 Default: Off
Delta Temperature Unit of Measure: °F Resolution: 0.1 °F Invalid data: "--"	High Limit	Off, 1.0 to 10.0 Default: Off	Off, 1.0 to 10.0 Default: Off	Off, 1.0 to 10.0 Default: Off
	Low Limit	N/A	N/A	N/A
Delta Temperature Unit of Measure: °C Resolution: 0.1 °C Invalid data: "--"	High Limit	Off, 1.0 to 10.0 Default: Off	Off, 1.0 to 10.0 Default: Off	Off, 1.0 to 10.0 Default: Off
	Low Limit	N/A	N/A	N/A
TBlood Unit of Measure: °F Resolution: 0.1 °F Invalid data: "--"	High Limit	Off, 95.0 to 110.0 Default: Off	Off, 95.0 to 110.0 Default: Off	N/A
	Low Limit	Off, 80.0 to 100.0 Default: Off	Off, 80.0 to 100.0 Default: Off	N/A
TBlood Unit of Measure: °C Resolution: 0.1 °C Invalid data: "--"	High Limit	Off, 35.0 to 43.0 Default: Off	Off, 35.0 to 43.0 Default: Off	N/A
	Low Limit	Off, 26.0 to 38.0 Default: Off	Off, 26.0 to 38.0 Default: Off	N/A

8.2.2.4 Gases Tab

TABLE 8-5 lists the alarm limit ranges for the parameters contained in the **Gases** tab.

TABLE 8-5

PARAMETER	ALARM LIMIT	ADULT	PEDIATRIC	NEONATE
SpO2 Unit of Measure:% Resolution: 1% Invalid data: "--"	High Limit	Off, 75 to 101 Default: 101	Off, 75 to 101 Default: 101	Off, 75 to 101 Default: 101
	Low Limit	70 to 99 Default: 88	70 to 99 Default: 90	70 to 99 Default: 92
CO2 ET Unit of Measure: mmHg Resolution: 1 mmHg	High Limit	Off, 20 to 80 Default: 60	Off, 20 to 80 Default: 60	Off, 20 to 80 Default: 60
	Low Limit	Off, 5 to 50 Default:15	Off, 5 to 50 Default:15	Off, 5 to 50 Default:15
CO2 ET Unit of Measure:% Resolution: 0.1%	High Limit	Off, 2.0 to 10.0 Default:10.0	Off, 2.0 to 10.0 Default:10.0	Off, 2.0 to 10.0 Default:10.0
	Low Limit	Off, 1.0 to 6.0 Default: 2.0	Off, 1.0 to 6.0 Default: 2.0	Off, 1.0 to 6.0 Default: 2.0
CO2 ET Unit of Measure: kPa Resolution: 0.1 kPa	High Limit	Off, 2.0 to 10.0 Default: 10.0	Off, 2.0 to 10.0 Default: 10.0	Off, 2.0 to 10.0 Default: 10.0
	Low Limit	Off, 1.0 to 6.0 Default: 2.0	Off, 1.0 to 6.0 Default: 2.0	Off, 1.0 to 6.0 Default: 2.0
CO2 INSP Unit of Measure: mmHg Resolution: 1 mmHg	High Limit	Off, 5 to 30 Default: 10	Off, 5 to 30 Default: 10	Off, 5 to 30 Default: 10
	Low Limit	N/A	N/A	N/A
CO2 INSP Unit of Measure:% Resolution: 0.1%	High Limit	Off, 1.0 to 4.0 Default: 1.0	Off, 1.0 to 4.0 Default: 1.0	Off, 1.0 to 4.0 Default: 1.0
	Low Limit	N/A	N/A	N/A
CO2 INSP Unit of Measure: kPa Resolution: 0.1 kPa	High Limit	Off, 1.0 to 4.0 Default: 1.0	Off, 1.0 to 4.0 Default: 1.0	Off, 1.0 to 4.0 Default: 1.0
	Low Limit	N/A	N/A	N/A

TABLE 8-5

PARAMETER	ALARM LIMIT	ADULT	PEDIATRIC	NEONATE
Des Insp Unit of Measure:% Resolution: 0.1%	High Limit	Off, 0.2 to 18.0 Default: 6.0	Off, 0.2 to 18.0 Default: 6.0	Off, 0.2 to 18.0 Default: 6.0
	Low Limit	Off, 0.0 to 17.8 Default: Off	Off, 0.0 to 17.8 Default: Off	Off, 0.0 to 17.8 Default: Off
Des ET Unit of Measure:% Resolution: 0.1%	High Limit	Off, 0.2 to 18.0 Default: Off	Off, 0.2 to 18.0 Default: Off	Off, 0.2 to 18.0 Default: Off
	Low Limit	Off, 0.0 to 17.8 Default: Off	Off, 0.0 to 17.8 Default: Off	Off, 0.0 to 17.8 Default: Off
Enf Insp, Hal Insp, Iso Insp Unit of Measure:% Resolution: 0.1%	High Limit	Off, 0.2 to 5.0 Default: 2.0	Off, 0.2 to 5.0 Default: 2.0	Off, 0.2 to 5.0 Default: 2.0
	Low Limit	Off, 0.0 to 4.8 Default: Off	Off, 0.0 to 4.8 Default: Off	Off, 0.0 to 4.8 Default: Off
Enf ET, Hal ET, Iso ET Unit of Measure:% Resolution: 0.1%	High Limit	Off, 0.2 to 5.0 Default: Off	Off, 0.2 to 5.0 Default: Off	Off, 0.2 to 5.0 Default: Off
	Low Limit	Off, 0.0 to 4.8 Default: Off	Off, 0.0 to 4.8 Default: Off	Off, 0.0 to 4.8 Default: Off
Sev Insp	High Limit	Off, 0.2 to 8.0 Default: 5.0	Off, 0.2 to 8.0 Default: 5.0	Off, 0.2 to 8.0 Default: 5.0
	Low Limit	Off, 0.0 to 7.8 Default: Off	Off, 0.0 to 7.8 Default: Off	Off, 0.0 to 7.8 Default: Off
Sev ET	High Limit	Off, 0.2 to 8.0 Default: Off	Off, 0.2 to 8.0 Default: Off	Off, 0.2 to 8.0 Default: Off
	Low Limit	Off, 0.0 to 7.8 Default: Off	Off, 0.0 to 7.8 Default: Off	Off, 0.0 to 7.8 Default: Off
O2 Insp Unit of Measure:% Resolution: 1%	High Limit	Off, 40 to 100 Default: Off	Off, 40 to 100 Default: Off	Off, 40 to 100 Default: Off
	Low Limit	Off, 18 to 60 Default: 18	Off, 18 to 60 Default: 18	Off, 18 to 60 Default: 18
O2 ET Unit of Measure:% Resolution: 1%	High Limit	Off, 40 to 100 Default: Off	Off, 40 to 100 Default: Off	Off, 40 to 100 Default: Off
	Low Limit	Off, 10 to 60 Default: Off	Off, 10 to 60 Default: Off	Off, 10 to 60 Default: Off

TABLE 8-5

PARAMETER	ALARM LIMIT	ADULT	PEDIATRIC	NEONATE
N2O Insp Unit of Measure:% Resolution: 1%	High Limit	Off, 10 to 80 Default: 80	Off, 10 to 80 Default: 80	Off, 10 to 80 Default: 80
	Low Limit	Off, 5 to 70 Default: Off	Off, 5 to 70 Default: Off	Off, 5 to 70 Default: Off
N2O ET Unit of Measure:% Resolution: 1%	High Limit	Off, 10 to 80 Default: Off	Off, 10 to 80 Default: Off	Off, 10 to 80 Default: Off
	Low Limit	Off, 5 to 70 Default: Off	Off, 5 to 70 Default: Off	Off, 5 to 70 Default: Off

8.2.2.5 CCO/Hemo Tab

Refer to the Addendum to V Series Operating Instructions for additional information.

8.2.3 Oximetry

TABLE 8-6 lists the available alarm limits for the SpO₂ parameter in the **Oximetry** tab.

TABLE 8-6

PARAMETER	ALARM LIMIT	ADULT	PEDIATRIC	NEONATE
SpO2 Unit of Measure:% Resolution: 1% Invalid data: "- -"	High Limit	Off, 75 to 101 Default: 101	Off, 75 to 101 Default: 101	Off, 75 to 101 Default: 101
	Low Limit	70 to 99 Default: 88	70 to 99 Default: 90	70 to 99 Default: 92

NOTE: For the rSO₂ alarm limit ranges, refer to the Addendum to V Series Operating Instructions for additional information.

8.2.3.1 Auto-Set All Alarms Button

The **Auto-Set All** button automatically recalculates high and low alarm limit settings to the percent indicated in TABLE 8-7 above and below the patient's current measured value for the selected parameter.

TABLE 8-7

ALARM	PERCENT INDICATOR (APPROXIMATE)
Heart Rate	30%
Respiration	30%
IBP Systolic	20%
IBP Diastolic	20%
IBP Mean	20%

TABLE 8-7

ALARM	PERCENT INDICATOR (APPROXIMATE)
NIBP Systolic	20%
NIBP Diastolic	20%
NIBP Mean	20%
ET CO ₂ (mmHg)	20%
ET CO ₂ (%)	20%
INSP CO ₂ (mmHg)	20%
INSP CO ₂ (%)	20%
ET CO ₂ (kPa)	20%
INSP CO ₂ (kPa)	20%
Temp (°F)	3%
Temp (°C)	3%
Delta Temp (°F)	25%
Delta Temp (°C)	25%

NOTE: The systolic, diastolic, and mean NIBP values flash in the corresponding alarm priority color when an alarm is active.

8.2.3.2 Restore All Defaults Button

Restores all alarm limits to the departmental default values.

8.3 Alarm Responses

Use the Responses dialog to set the parameter's alarm level (or alarm priority) and the alarm responses. Alarm level is associated with the severity of an alarm condition and determines the audio and visual indicators that occur during an alarm condition. Alarm responses are used to adjust how the system reacts or responds during an alarm condition. For example, if Nurse Call is selected, and a HR alarm occurs, an electronic signal is sent to the Nurse Call system.

NOTE: **Nurse Call is not an available alarm response unless it was enabled in System Setup.**

The Responses dialog contains the following tabs: **ECG/Resp, Pressure, Temp, Gases, CCO/Hemo,** and **Oximetry**. A description of each tab follows.

8.3.1 Understanding Alarm Levels

Assigning an alarm level or priority is based on the patient's condition. For example, lethal alarms, because of their critical nature, are usually the highest priority alarms. The parameter's alarm level (shown as a colored oval) appears beside the corresponding parameter alarm limits button in the Alarm Limits dialog (as shown in FIGURE 8-2).

BUTTON	DESCRIPTION
High	Violating the alarm limits of this parameter is life threatening for this patient.
Medium	Violating the alarm limits of this parameter is critical, but not life threatening for this patient.
Low	Violating the alarm limits of this parameter is neither critical nor life threatening for this patient.

8.3.2 Factory Default Alarm Priorities between Alarm Types

The **V 12/V 21** prioritizes **high** priority arrhythmia alarms in the following order:

- Asystole
- Ventricular Fibrillation
- Ventricular Tachycardia
- Bradycardia
- R-On-T PVC
- Pause

The **V 12/V 21** prioritizes **medium** priority arrhythmia alarms in the following order:

- Bradycardia
- R-On-T PVC
- Pause
- Run
- Ventricular Rhythm
- Bigeminy
- Trigeminy
- Couplet
- Irregular HR
- Multiform PVC

The **V 12/V 21** prioritizes **low/technical** priority arrhythmia alarms in the following order:

- Pause
- Ventricular Rhythm
- Run
- Bigeminy
- Trigeminy
- Couplet
- Irregular HR
- Multiform PVC
- Leads Off

8.3.3 Configuring Alarm Levels

1. Select the **Alarms** tab from the Navigation Area.
2. Select the **Responses** button.
3. Select the applicable alarm group tab.
4. Select the applicable parameter alarm level radio button.

NOTE: **The alarm levels available are based on the parameter. Some parameters will not have all three levels available, as shown in FIGURE 8-3.**

8.3.4 Understanding Alarm Response Settings

Based on the selected alarm responses, several monitor responses may occur when a parameter alarm occurs. Configure each parameter to use any of the following responses:

- **Print on Alarm** directs the monitor to send the alarm data to the configured printer.
- **Save to Event** directs the monitor to mark the event and save it to the events database.
- **Nurse Call** directs the monitor to send an electronic signal to the Nurse Call system.

NOTE: **Nurse Call is not an available alarm response unless it was enabled in System Setup.**

8.3.5 Configuring Alarm Response Settings

1. Select the **Alarms** tab from the Navigation Area.
2. Select the **Responses** button.
3. Select the applicable alarm group tab.
4. Select the applicable alarm level.

NOTE: **Before setting the alarm responses, refer to "Factory Default Alarm Settings" on page 8-14 for additional information.**

5. Optional - select the applicable parameter alarm check boxes under the headings: **Print on Alarm**, **Save to Event**, and **Nurse Call**.
6. Select the **Cancel** or **Accept** button.
 - The **Cancel** button closes the dialog without saving the settings.
 - The **Accept** button saves the settings and closes the dialog.

8.3.6 Factory Default Alarm Settings

8.3.6.1 ECG/Resp Tab

TABLE 8-8 lists the available alarm levels for each parameter in the **ECG/Resp** tab.

TABLE 8-8

ALARM LEVELS BUTTON	ALARM LEVELS*			FACTORY DEFAULT ALARM RESPONSES		
	HIGH	MEDIUM	LOW	PRINT ON ALARM	SAVE TO EVENT	NURSE CALL
HR	X	X***	—	Off	On	Off
ST**	X	X	X	Off	On	Off
Resp	X	X	X	Off	On	Off
Apnea	X	X	—	Off	On	Off

* X indicates available alarm level, — indicates alarm level not available

** Only available when patient size is Adult or Pediatric

*** The factory default configuration settings are in bold.

8.3.6.2 Pressure Tab

TABLE 8-9 lists the available alarm levels for each parameter in the **Pressure** tab.

TABLE 8-9

ALARM LEVELS BUTTON	ALARM LEVELS*			FACTORY DEFAULT ALARM RESPONSES		
	HIGH	MEDIUM	LOW	PRINT ON ALARM	SAVE TO EVENT	NURSE CALL
NIBP	—	X	X***	Off	On	Off
IBP 1-8	—	X	X	Off	On	Off

* X indicates available alarm level, — indicates alarm level not available

*** The factory default configuration settings are in bold.

8.3.6.3 Temp Tab

TABLE 8-10 lists the available alarm levels for each parameter in the **Temp** tab.

TABLE 8-10

ALARM LEVELS BUTTON	ALARM LEVELS*			FACTORY DEFAULT ALARM RESPONSES		
	HIGH	MEDIUM	LOW	PRINT ON ALARM	SAVE TO EVENT	NURSE CALL
T1 - T3	—	X	X**	Off	On	Off

* X indicates available alarm level, — indicates alarm level not available

** The factory default configuration settings are in bold.

TABLE 8-10

ALARM LEVELS BUTTON	ALARM LEVELS*			FACTORY DEFAULT ALARM RESPONSES		
	HIGH	MEDIUM	LOW	PRINT ON ALARM	SAVE TO EVENT	NURSE CALL
Delta Temp	—	X	X	Off	On	Off
T Blood	—	X	X	Off	On	Off

* X indicates available alarm level, — indicates alarm level not available

** The factory default configuration settings are in bold.

8.3.6.4 Gases Group

TABLE 8-11 lists the available alarm levels for each parameter in the **Gases** tab.

TABLE 8-11

ALARM LEVELS BUTTON	ALARM LEVELS*			FACTORY DEFAULT ALARM RESPONSES		
	HIGH	MEDIUM	LOW	PRINT ON ALARM	SAVE TO EVENT	NURSE CALL
SpO2	X	X**	—	Off	On	Off
CO2	X	X	—	Off	On	Off
Agent	—	X	—	Off	On	Off
O2	X	—	—	Off	On	Off
N2O	—	X	—	Off	On	Off

* X indicates available alarm level, — indicates alarm level not available

** The factory default configuration settings are in bold.

8.3.6.5 CCO/Hemo Tab

Refer to the Addendum to V Series Operating Instructions for additional information.

8.3.6.6 Oximetry Tab

TABLE 8-12 lists the available alarm levels for the SpO₂ parameter in the **Oximetry** tab.

TABLE 8-12

ALARM LEVELS BUTTON	ALARM LEVELS*			FACTORY DEFAULT ALARM RESPONSES		
	HIGH	MEDIUM	LOW	PRINT ON ALARM	SAVE TO EVENT	NURSE CALL
SpO2	X	X**	—	Off	On	Off

* X indicates available alarm level, — indicates alarm level not available

** The factory default configuration settings are in bold.

NOTE: For the rSO₂ alarm responses, refer to the Addendum to V Series Operating Instructions for additional information.

8.4 Arrhythmia Alarms

Use the Arrhythmia Alarm dialog to set the parameter's alarm level (or priority) and the alarm responses for arrhythmia alarms. The alarm level determines the priority at which a parameter's alarm violation is actuated. Also use this tab to configure the arrhythmia alarm responses during an alarm condition.

NOTE: The Arrhythmia Alarm dialog is only available when the patient size is Adult or Pediatric.

8.4.1 Understanding Alarm Levels

Refer to "Understanding Alarm Levels" on page 8-12 for additional information.

8.4.2 Configuring Arrhythmia Alarm Levels

1. Select the **Alarms** tab from the Navigation Area.
2. Select the **Arrhythmia** button.
3. Select the **On/Off** check box to turn on/off the alarm (as shown in FIGURE 8-3).

NOTE: Selecting the On/Off check box enables or disables the alarm response's radio button.

NOTE: Through the System button in the Navigator Area, the administrator can lock Asystole, Ventricular Tachycardia, and Ventricular Fibrillation settings which controls the ability to enable or disable the lethal arrhythmias. Refer to "Configuring the Printer Tab" on page 25-9 for additional information.



FIGURE 8-3 Example Arrhythmia Dialog (Arrhythmia Tab)

4. Select the alarm levels manually (refer to table TABLE 8-13 for default alarm levels) or select one of the buttons in TABLE 8-14 to make automatic updates.

TABLE 8-13**FACTORY DEFAULT ALARM LEVELS***

BUTTON	DEFAULT ON/OFF**	HIGH	MEDIUM	LOW
Asystole	On	X**	—	—
Ventricular Tachycardia (V-Tach)	On	X	—	—
Ventricular Fibrillation(V-Fib)	On	X	—	—
Bradycardia	Off	X	—	—
R-On- T PVC	Off	X	X	—
Pause	Off	X	X	X
Pauses/Minute	Off	X	X	X
Bigeminy	Off	—	X	X
PVCs/Minute	Off	—	X	X
Couplet	Off	—	X	X
Irregular HR	Off	—	X	X
Multiform PVC	Off	—	X	X
Run	Off	—	X	X
Trigeminy	Off	—	X	X
Ventricular Rhythm	Off	—	X	X

* *X indicates available alarm level, — indicates alarm level not available*

** *The factory default configuration settings are in bold.*

TABLE 8-14

BUTTON	DESCRIPTION
All On	Configures all arrhythmia alarms to on.
All Off	Configures all lethal arrhythmia alarms to off, except Asystole, Ventricular Tachycardia, and Ventricular Fibrillation if they were locked by the administrator.
Lethals Only On	Configures the lethal arrhythmia alarms (Asystole, V-Tach, and V- Fib) to on and set all non-lethal arrhythmias to off.

5. Optional - Select the **Relearn Arrhythmia** button to establish a new base line.
6. Select the **Cancel** or **Accept** button.
- The **Cancel** button closes the dialog without saving the settings.
 - The **Accept** button saves the settings and closes the dialog.

8.4.3 Understanding Arrhythmia Alarm Responses

Setting the alarm responses directs the monitor how to manage the alarm. Configure any alarm with the following alarm responses:

- **Audio On** directs the monitor to present an audible alarm.
- **Print on Alarm** directs the monitor to send the alarm data to the configured printer.
- **Save to Event** directs the monitor to mark the event and save it to the events database.
- **Nurse Call** directs the monitor to send an electronic signal to the Nurse Call system.

NOTE: **Nurse Call is not an available alarm response unless it is enabled in System Setup.**

8.4.4 Configuring the Arrhythmia Alarm Responses

1. Select the **Alarms** tab from the Navigation Area.
2. Select the **Arrhythmia** button.
3. Select the **Responses** tab.
4. Select an alarm response.

NOTE: **Before selecting an alarm response, refer to TABLE 8-15 for additional information.**

TABLE 8-15

**FACTORY
DEFAULT ALARM RESPONSES**

ALARM	AUDIO ON	PRINT ON ALARM	SAVE TO EVENT	NURSE CALL*
Asystole	**	Off	On	Off
Ventricular Tachycardia (V-Tach)	**	Off	On	Off
Ventricular Fibrillation (V-Fib)	**	Off	On	Off
Bradycardia	On	Off	On	Off
R-on-T PVC	On	Off	On	Off
Pause	On	Off	On	Off
Pauses/Minute	On	Off	On	Off
Bigeminy	On	Off	On	Off
PVCs/Minute	On	Off	On	Off
Couplet	On	Off	On	Off
Irregular HR	On	Off	On	Off
Multiform PVC	On	Off	On	Off
Run	On	Off	On	Off
Trigeminy	On	Off	On	Off
Ventricular Rhythm	On	Off	On	Off

* *Nurse Call is not an available alarm response unless it is enabled in System Setup.*

** *By default, audio for these lethal alarms is on even though there are no Audio On settings shown.*

5. Select the **Cancel** or **Accept** button.
 - The **Cancel** button closes the dialog without saving the settings.
 - The **Accept** button saves the settings and closes the dialog.

8.4.5 Configuring Arrhythmia Alarm Setup

1. Select the **Alarms** tab from the Navigation Area.
2. Select the **Arrhythmia** button.
3. Select the **Setup** button.
4. Select the buttons described in TABLE 8-16 to configure the tab.

TABLE 8-16

BUTTON	DESCRIPTION/ COMMENTS	SETTINGS
Asystole Delay	Configures how many seconds should occur between QRS complexes to be defined as Asystole.	3 sec, 4 sec , 5 sec, 6 sec, 7 sec, 8 sec, 9 sec, 10 sec
V-Tach Run	Configures how many ventricular beats must occur in a row in order to be defined as a V-Tach.	3 to 15 beats in increments of one (1) beat
V-Tach Rate	Configures how fast the ventricular beat rate must be to be defined as a V-Tach.	100 bpm - 180 bpm in increments of one (1) bpm, 120 default
Pause Threshold	Configures the Pause Threshold.	1.2, 1.3, 1.4, 1.5, 1.6, 1.7, 1.8, 1.9, and 2.0
Pauses Per Minute	Configures the Pauses per Minute arrhythmia call.	1 to 15 Pause/min in 1 Pause/min steps Default: 8
PVCs Per minute	Configures the PVCs per Minute arrhythmia call.	1 to 30 PVC/min in 1 PVC/min steps Default: 10

* *The factory default configuration settings are in bold.*

5. Select the **Cancel** or **Accept** button.
 - The **Cancel** button closes the dialog without saving the settings.
 - The **Accept** button saves the settings and closes the dialog.

8.5 Alarm Setup

Use the **Alarm Setup** tab to configure the alarm silence and alarm audio delay settings.

8.5.1 Configuring Alarm Setup

1. Select the **Alarms** tab from the Navigation Area.
2. Select the **Alarm Setup** button to display the **Alarm Setup** dialog (as shown in FIGURE 8-4).

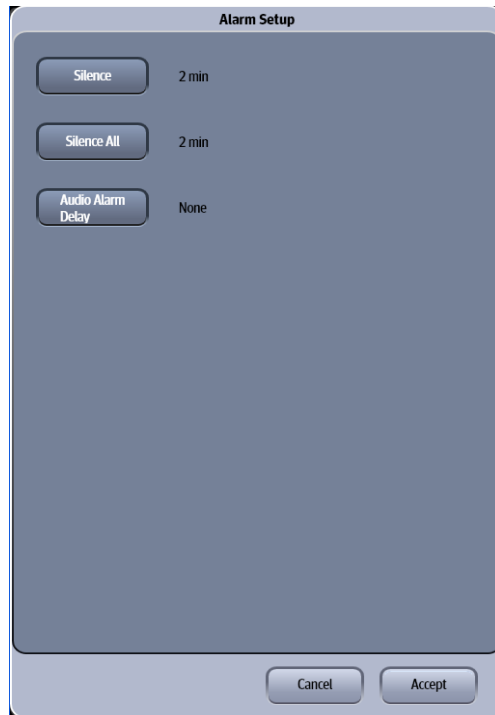

FIGURE 8-4 Example Alarm Setup Tab

3. Select the buttons described in TABLE 8-17 to configure the tab.

TABLE 8-17

FUNCTION	DESCRIPTION	SETTINGS*
Silence	Configures temporary alarm silencing.	1 min, 2 min , 5 min and 10 min
Silence All	The choices displayed here are specified in the System Setup Alarms tab.	Dependent on the System configuration. Refer to "Configuring the Alarms Tab" on page 25-6 for additional information.
Audio Alarm Delay	Configures whether or not there is a delay before an alarm sounds.	None , 1 sec, 2 sec, 3 sec, 4 sec, 5 sec, 6 sec, 7 sec, and 8 sec

* *The factory default configuration settings are in bold.*

4. Select the **Cancel** or **Accept** button.
 - The **Cancel** button closes the dialog without saving the settings.
 - The **Accept** button saves the settings and closes the dialog.

8.6 Alarms Troubleshooting

MESSAGE/PROBLEM	REASON	SOLUTION
No alarm sounds.	The Silence All or Silence button was selected.	Select the Silence All or Silence button to hear the alarm sounds.
	Audio levels were turned down or turned off.	Refer to "Configuring Audio Levels" on page 2-14 for additional information.
System not calling Apnea alarms.	Apnea alarms were disabled.	Enable apnea alarms in the Alarm Limits dialog ECG/Resp tab.
	Apnea delay is enabled.	Disable apnea delay alarms in the Alarm Limits dialog ECG/Resp tab.
Cannot configure Pressure alarms to high.	Cannot configure Pressure alarms to high. Only medium and low settings are available for the Pressure alarms.	N/A
Cannot configure Temp alarms to high.	Cannot configure Temp alarms to high. Only medium and low settings are available for the Temp alarms.	N/A
Cannot configure the SpO ₂ /Gases alarms to low.	Cannot configure SpO ₂ /Gases alarms to low. Only high and medium settings are available for the SpO ₂ /Gases alarms.	N/A
Lethal alarms not being called.	Lethal alarms were disabled in the Arrhythmia Alarms dialog.	Refer to "Understanding Alarm Levels" on page 8-12 for additional information.
All Alarms Permanently Silenced displays in the Main Display message area.	The Silence All button was configured for Permanent.	Select the Silence All button to hear the alarms.
Would like to remove the Permanent choice from the Silence All button configuration options.	Must remove this configuration option in the password protected System Setup dialog.	Refer to "Configuring the Printer Tab" on page 25-9 for additional information.
Lethal alarms are disabled.	Lethal alarms were disabled in the password protected System Setup dialog.	Refer to "Configuring the Printer Tab" on page 25-9 for additional information.
Apnea alarms are disabled.	Apnea alarms were disabled in the password protected System Setup dialog.	Refer to "Configuring the Printer Tab" on page 25-9 for additional information.

* *Display messages are shown in bold text.*

This page intentionally left blank.

ECG – Arrhythmia

Introduction	9-2
ECG Dialog	9-3
Arrhythmia Digital Tile Layout	9-9
ECG Waveform Tile Layout.....	9-10
Preparation and Lead Placement.....	9-12
Arrhythmia Algorithm.....	9-23
Arrhythmia Alarms	9-25
ST Segment Analysis.....	9-29
12 Lead Interpretation	9-31
ECG-Arrhythmia Troubleshooting.....	9-34

9.1 Introduction

This chapter describes the ECG – Arrhythmia dialogs in detail, including configuring alarm limits, parameter setup, waveform speed, skin preparation and lead placement, the arrhythmia algorithm, and 12 Lead Interpretation. ECG is a continuous waveform of a patient's cardiac electrical activity. An ECG waveform displays in the first waveform area of the **V 12/V 21**.

The quality of an ECG signal is directly affected by electrode site skin preparation, electrode patch quality and ECG lead placement. If artifact is present on the ECG waveform, then the arrhythmia processing, alarm processing, and quality of the monitoring function may be affected. The presence of artifact can prevent the monitor from establishing an accurate ECG reference waveform, increasing the difficulty experienced in assessing the ECG rhythm.

Optimizing the ECG signal is imperative for accurate monitoring. Use high quality electrodes, designed to acquire the ECG with excellent base line stability, recovery from defibrillation and minimum artifact from patient movement.

With the **V 12/V 21**, ECG can be obtained by using a 3/5/6/12 lead ECG cable in conjunction with the matching skin electrodes. For best performance and safety, inspect the ECG cables and electrodes daily.

Patient Sizes

Intended patient types for Arrhythmia: Adult and Pediatric;

Intended patient types for 12 Lead Interpretation: Adult, Pediatric, and Neonate.

VPS Connector

The VPS module supports one (1) ECG/EKG connector (shown in FIGURE 9-1).

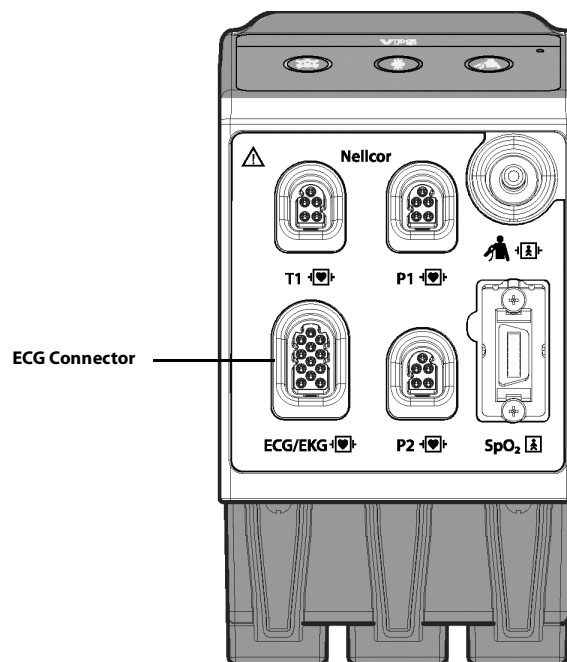

FIGURE 9-1 Example VPS ECG Connector (Nelcor)

Display Setup

To see the ECG values, Arrhythmia must be configured to display on the Main Screen. Refer to "Display Options Dialog" on page 3-2 for additional information.

9.2 ECG Dialog

The **ECG** dialog (as shown in 9-2) contains an **Arrhythmia** tab, **Pacer** tab, **ECG Setup** tab, and **Arrhy Setup** tab. A description of each tab follows.

9.2.1 Navigating to the ECG Dialog

- Select the Arrhy digital or ECG waveform tile.

OR

1. Select the **Setup** tab from the Navigation Area.
2. Select the **Parameters** button.
3. Select the **ECG** button to display the **ECG** dialog (as shown in FIGURE 9-2).



FIGURE 9-2 Example ECG Dialog (Arrhythmia Tab)

9.2.2 Configuring the Arrhythmia Tab

Refer to "Arrhythmia Alarms" on page 8-16 for additional information.

9.2.3 Configuring Pacemakers

1. Select the Arrhy digital or ECG waveform tile.
2. Select the **Pacer** tab (as shown in FIGURE 9-3).

NOTE: The current parameter setting displays in bold to the right of the button.

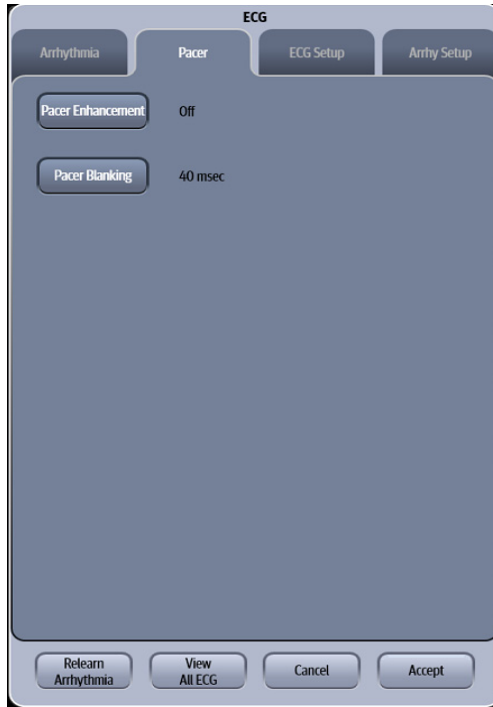

FIGURE 9-3 Example ECG Dialog (Pacer Tab)

3. Select the buttons described in TABLE 9-1 to configure the tab.

TABLE 9-1

FUNCTION	DESCRIPTION	SETTINGS*
Pacer Enhancement**	Configures whether or not to display the pacer markers in the waveform.	Adult and Pediatric settings: On, Off
Pacer Blanking**	Configures the pacer blanking filter.	Adult and Pediatric settings: Off , 20 msec, 30 msec, and 40 msec

* The factory default configuration settings are in bold.

** Only available when patient size is Adult or Pediatric.

4. Select the **Cancel** or **Accept** button.
 - The **Cancel** button closes the dialog without saving the settings.
 - The **Accept** button saves the settings and closes the dialog.

9.2.4 Configuring ECG Setup

NOTE: The ECG Setup tab can also be accessed from the ECG dialog.

NOTE: The current parameter setting displays in bold to the right of the button.

1. Select the Arrhy digital or ECG waveform tile.
2. Select the **ECG Setup** tab (as shown in FIGURE 9-4 and FIGURE 9-5).



FIGURE 9-4 Example ECG Setup tab Accessed from ECG Waveform Tile



FIGURE 9-5 Example ECG Setup Tab Accessed from Arrhy Digital Tile

3. Select the buttons described in TABLE 9-2 to configure the tab.

TABLE 9-2

BUTTON	DESCRIPTION/ COMMENTS	SETTINGS*
ECG Leads	Configures the ECG lead that displays in the selected waveform tile. NOTE: The ECG Leads button only displays when the ECG dialog is accessed from the ECG waveform tile. It is not shown when accessing the ECG dialog from selecting the Arrhy digital tile.	Dependent on the lead set currently in use.
Size	Configures the ECG waveform size for each unique lead type in all operating modes.	0.125 cm/mv, 0.25 cm/mv, 0.5 cm/mv, 1 cm/mv , 2 cm/mv, 4cm/mv
Filter	Configures the ECG filter in all operating modes.	Monitor , ST, Diagnostic Refer to "ECG Filters" on page 9-30 for additional information.
ECG Cable Type	Configures the current ECG Cable.	3 Lead, 5 Lead , 6 Lead, and 12 Lead
Color	Configures the ECG waveform color.	16 distinct colors Default color is green .
Notch Filter	Configures the ECG Notch filter. This menu item is used to filter out AC line noise from the ECG waveform.	Off, 50 Hz, 60 Hz The default is 50 Hz when the monitor is not configured for the US.

* *The factory default configuration settings are in bold.*

TABLE 9-2

BUTTON	DESCRIPTION/ COMMENTS	SETTINGS*
ESU Filter	Configures the ESU filter in all operating modes. This menu item is used to filter out high frequency electrosurgical noise from the ECG waveform.	Auto , Disable
ECG/SpO2 Speed	Configures the speed of ECG/SpO ₂ waves.	6.25 mm/sec, 12.5 mm/sec, 25 mm/sec , 50 mm/sec
ECG Noise Audio	Configures the ECG Noise Alarm in all operating modes. If turned on, an alarm sounds when ECG noise is detected on any of the active ECG leads.	On , Off
Noise Audio Delay	Configures the delay time before the ECG Noise Alarm is called, if the option is enabled.	3 to 60 seconds in steps of 1 second Default is 5 seconds.

* *The factory default configuration settings are in bold.*

9.2.5 Configuring the Arrhy Setup

Refer to "Configuring Arrhythmia Alarm Setup" on page 8-19 for additional information.

9.2.6 Relearning

A relearn can be done for arrhythmia, ST analysis, or for both simultaneously.

NOTE: **ST Analysis must be turned on before it will relearn.**

The **V 12/V 21** initiates the learning process for ST or Arrhythmia analysis after any of the following:

- Unit power-up
- Return to normal monitoring from standby mode
- Enabling ST or Arrhythmia analysis
- The lead has been changed in ECG 1 waveform (3 lead only)
- **Patient Size** changes
- Selecting the **Relearn Both** button in the **ST**, **ECG**, or **Arrhythmia** tab
- Selecting the **Relearn Arrhythmia** button or **Relearn Both** button is *recommended* after one or more of the following:
 - ECG electrodes have been repositioned
 - Eight hours have passed since the last relearn
 - Significant changes occurred to the patient QRS complex
 - Significant changes occurred to the patient ECG rhythm
 - A clinician has observed clinically questionable arrhythmia calls
 - "Learning" occurred during a **Leads Off** condition

Relearning Arrhythmia

To relearn arrhythmia:

1. Select the Arrhy digital tile.
2. Select the **Relearn Arrhythmia** button.
The **Arrhythmia Learning** message displays in the ECG waveform tile.

Relearning Arrhythmia and ST

To relearn ST:

1. Select one of the ECG waveform tiles.
2. Select the **Relearn Both** button.
The **Arrhythmia Learning** message displays in the ECG waveform tile.

NOTE: To relearn ST only, refer to "Configuring the ST Parameter" on page 16-3 for additional information.

9.2.7 Viewing All ECG Waveforms

Using a **V 12** with a 5 or 6 lead wire set:

- Select the **View All ECG** button from any of the ECG dialog tabs.
The ECG dialog automatically closes and the seven (7) or eight (8) ECG waveforms populate the waveform tiles.

Using a **V 12** with a 12 lead wire set:

1. Select the Arrhy digital or ECG waveform tile.
2. Select the **View All ECG** button.
The ECG dialog automatically closes and the first six (6) ECG waveforms populate the ECG waveform tiles.
3. Select the **View All ECG** button again to view the next six (6) leads.

Using a **V 21** with a 5, 6, or 12 lead wire set:

1. Select the Arrhy digital or ECG waveform tile.
2. Select the **View All ECG** button.
The ECG dialog automatically closes and the six (6), eight (8), or twelve (12) ECG waveforms populate the waveform tiles.

NOTE: The **View All ECG** button is also available in the **Display Options** dialog. Refer to "View All ECG Mode" on page 3-17 for additional information.

NOTE: The **View All ECG** button may also be **Quick Function** button. Refer to "Configuring the Quick Functions Tab" on page 25-4 for additional information.

9.3 Arrhythmia Digital Tile Layout

The Arrhythmia digital tile displays:

1. Tile name
2. Message area
3. Units of measure
4. PVC per minute value
5. Pauses per minute value
6. Pauses per minute label
7. PVCs per minute label

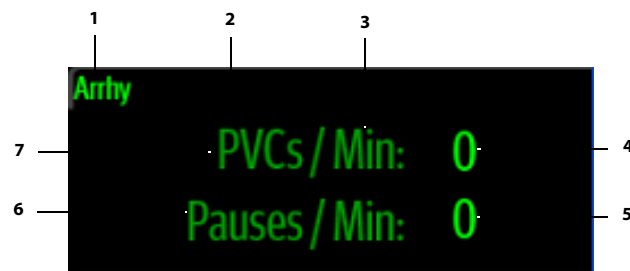

9.3.1 About the Arrhythmia Tile

- The Arrhy tile displays the PVC/Min in a 1 PVC/min resolution.
- The Arrhy tile displays the Pauses/Min in a 1 Pause/min resolution.
- If the PVC/Min or Pauses/Min measurement is invalid, "--" displays in place of digits.

9.3.2 Arrhythmia Alarms

Refer to "Arrhythmia Alarms" on page 9-25 for additional information.

9.3.3 Message Area

The message area provides information about the current state of the Arrhy parameter. If there is more than one message to display, the messages scroll.

MESSAGE	DETAILS
PVCs Per Minute Alarm	Indicates that the value is either equal to or higher than the set alarm limits.
Pauses Per Minute Alarm	Indicates that the value is either equal to or higher than the set alarm limits.

9.4 ECG Waveform Tile Layout

The ECG waveform tile displays:

1. ECG Lead
2. Message area
3. ECG waveform
4. ECG filter setting
5. ECG waveform size

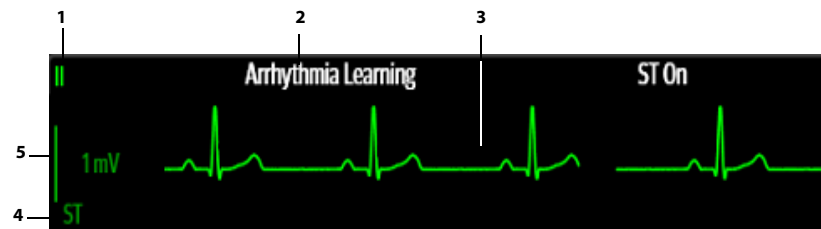

FIGURE 9-6 Example ECG Waveform Tile

9.4.1 About the ECG Tile

- The ECG waveform, scale indicator, units, and filter settings display in the configured ECG color.
- The ECG waveform tile provides scrolling, real-time waveform data and an erase bar to provide a time indicator of oldest and new data.
- The ECG waveform tile Scrolls the waveform in the configured sweep speed.
- The ECG waveform tile rails the top most value when the waveform exceeds the upper scale limit for real-time waveforms.
- The ECG waveform tile rails the bottom most value when the waveform exceeds the lower scale limit for real-time waveforms.
- The ECG waveform tile indicates the current ECG Filter setting.
- The ECG waveform tile indicates a Pacer indicator when a paced beat is detected and Pacer Enhancement is enabled.

9.4.2 Arrhythmia Alarms

Refer to the "Arrhythmia Alarms" on page 9-25 for additional information.

9.4.3 Message Area

The ECG waveform tile message area displays messages indicating the current state of the Arrhythmia and ECG parameters. Messages only display in the message area of the primary ECG lead, which occupies the top ECG waveform. If there is more than one message to display, excluding Asystole, V-Tach, and Ventricular Fibrillation, the messages scroll.

MESSAGE	DETAILS
Asystole	Indicates that an Asystole alarm condition exists.
Ventricular Tachycardia	Indicates that a Ventricular Tachycardia alarm condition exists.
Ventricular Fibrillation	Indicates that a Ventricular Fibrillation alarm condition exists.

MESSAGE	DETAILS
	NOTE: Asystole, Ventricular Tachycardia, and Ventricular Fibrillation messages are mutually exclusive of each other.
Bigeminy	Indicates that a Bigeminy alarm condition exists.
Bradycardia	Indicates that a Bradycardia alarm condition exists.
Couplet	Indicates that a Couplet alarm condition exists.
Irregular HR	Indicates that an Irregular Heart Rate alarm condition exists.
Multiform PVC	Indicates that a Multiform PVC alarm condition exists.
Pause	Indicates that a Pause alarm condition exists.
R-On-T PVC	Indicates that a R-On-T PVC alarm condition exists.
Run	Indicates that a Run alarm condition exists.
Trigeminy	Indicates that a Trigeminy alarm condition exists.
Ventricular Rhythm	Indicates that a Ventricular Rhythm alarm condition exists.
Pauses/Minute	Indicates that a Pauses/Minute alarm condition exists.
PVCs/Minute	Indicates that a PVCs/Minute alarm condition exists.
Leads Off	Indicates the detection of a single drive lead or other multiple leads are off.
<Lead> Lead Off	Indicates the detection of an event for a single, non-drive lead, where <Lead> is the ECG lead name.
Check ECG <Lead> Lead Connection	Indicates the detection of the corresponding event, where <Lead> is the problematic lead.
Check Lead Connections	Indicates the detection of an event for multiple leads.
Arrhythmia Learning	Indicates that Arrhythmia is in the learn mode.
ST Learning	Indicates that ST is enabled and is in the learn mode.
ST On	Indicates that ST is enabled and not in the learn mode.

9.5 Preparation and Lead Placement

9.5.1 Skin Preparation

Proper skin preparation is essential in obtaining an accurate ECG reading. Electrode sites should be clean and dry and should provide a smooth flat surface. Incidental electrical activity and inaccurate readings may arise from incorrect skin preparation.

The following procedure is recommended for secure electrode patch application:

1. Shave the chest hair from the electrode sites in a circular area with a diameter of 2 to 4 inches.
2. Use a dry gauze pad to remove excess skin oils, skin cells and residue from the electrode sites. Never rub the skin until it is raw or bleeding.

NOTE: Prepare the electrode site with alcohol only if the skin is extremely greasy. If alcohol is used as a drying agent, always allow the skin to dry before placing the electrode patch on the skin.

9.5.2 Electrode Patch Location

NOTE: Store electrode patches at room temperature and open just prior to use.

NOTE: Avoid more than one type of electrode on a patient because of variations in electrical resistance.

NOTE: Avoid placing electrode patches directly over bone prominences or over any high activity movement areas such as shoulders or arms because muscle motion produces electrical activity. If an electrode patch is placed over a large muscle such as the pectorals, the monitor may detect this additional muscle activity and could lead to false arrhythmia calls.

NOTE: Using a Transcutaneous Electrical Nerve Stimulator (TENS): Since a TENS unit transmits electrical impulses, avoid placing ECG electrode patches near the TENS electrodes. ECG electrode patches may need to be repositioned and the ECG lead viewed may need to be adjusted until the optimum ECG tracing is obtained.

1. To prevent evaporation of the contact gel medium, peel the backing off of the electrode patch only when it is ready for use. Visually inspect the contact gel medium for moistness. If the gel medium is not moist, do not use the electrode patch. Dry electrode patches are not conductive.

NOTE: If using the snap type electrode wires, attach the electrode patch to the lead wire before placing patch on the patient.

2. Attach the electrode patch to the skin at the prepared site. Smooth the electrode patch down in a circular motion to ensure proper skin contact. If using soft gel electrodes, never push down directly over the contact gel medium as this may displace the gel and cause monitoring artifact. If using hard gel electrodes, it is recommended that during application, the center of the electrode should be slightly pressed onto the skin to ensure direct contact. Consult the electrode patch manufacturer's instructions for specific use.
3. Secure the lead wires to the patient according to hospital practice.

CAUTION: Route cables and hoses neatly. Ensure cables, hoses and wires are kept away from patient's neck to avoid strangulation. Keep floors and walkways free of cables to reduce risk to hospital personnel, patients and visitors.

NOTE: It is recommended that electrode patches be changed at least every 24 to 36 hours to maintain proper contact with the skin, although some patients may require more frequent changing. Do not reapply disposable electrode patches. Try to avoid reusing the exact same electrode site during reapplication. If an electrode becomes wet with fluid, change the electrode patch.

9.5.3 Lead Placement

9.5.3.1 Description

For lead placement, the computerized arrhythmia algorithm works best when the patient's R wave is significantly larger than the P wave or the T wave. If the R wave is not significantly larger than other lower voltage waves on the ECG tracing, the monitor may have some difficulty in identifying the appropriate waves. On some patients, electrode patch placement and/or the viewed ECG lead may need to be adjusted in order to obtain a significant R wave.

9.5.3.2 Setting Lead Naming Standard

This manual presents lead placement according to the guidelines of the American Heart Association (AHA) and the International Electro-Technical Commission (IEC).

LEAD NAMING STANDARDS

LEAD POSITION	AHA	IEC
CHEST	V	C
LEFT LEG	LL	F
RIGHT LEG	RL	N
LEFT ARM	LA	L
RIGHT ARM	RA	R

9.5.3.3 Lead Placement: Standard 3-wire Lead Sets

A 3-wire lead set can monitor one of three ECG vectors (I, II, or III). The recommended 3-wire lead placement is as follows.

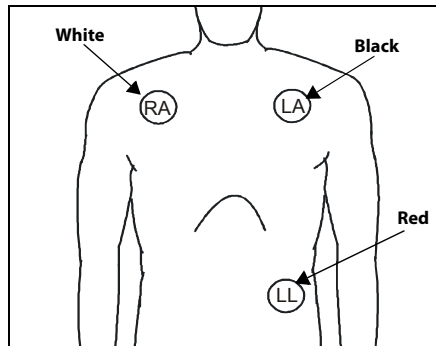

FIGURE 9-7 3-wire Lead Placement (AHA)

- Place the RA (white) electrode under the patient's right clavicle, at the mid-clavicular line within the rib cage frame.
- Place the LA (black) electrode under the patient's left clavicle, at the mid-clavicular line within the rib cage frame.
- Place the LL (red) electrode on the patient's lower left abdomen within the rib cage frame.

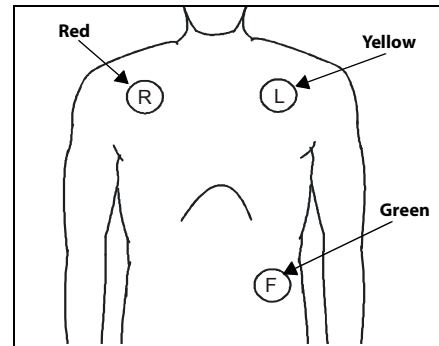

FIGURE 9-8 3-wire Lead Placement (IEC)

- Place the R (red) electrode under the patient's right clavicle, at the mid-clavicular line within the rib cage frame.
- Place the L (yellow) electrode under the patient's left clavicle, at the mid-clavicular line within the rib cage frame.
- Place the F (green) electrode on the patient's lower left abdomen within the rib cage frame.

9.5.3.4 Lead Placement: Standard 5-wire Lead Sets

A 5-wire lead set can monitor seven ECG vectors (I, II, III, aVR, aVL, aVF, and V) simultaneously. The recommended 5-wire lead placement is as follows.

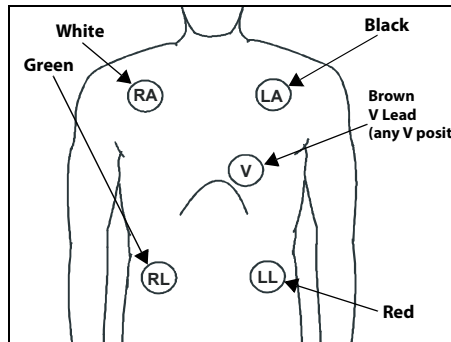

FIGURE 9-9 5-wire Lead Placement (AHA)

- Place the RA (white) electrode under the patient's right clavicle, at the mid-clavicular line within the rib cage frame.
- Place the LA (black) electrode under the patient's left clavicle, at the mid-clavicular line within the rib cage frame.
- Place the LL (red) electrode on the patient's lower left abdomen within the rib cage frame.
- Place the RL (green) electrode on the patient's lower right abdomen within the rib cage frame.
- Place the V (brown) electrode in one of the V-lead positions (V1 to V6) depicted in the following section.

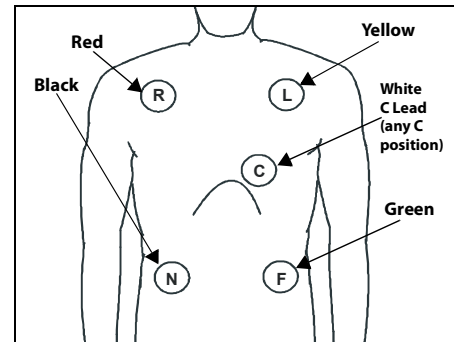

FIGURE 9-10 5-wire Lead Placement (IEC)

- Place the R (red) electrode under the patient's right clavicle, at the mid-clavicular line within the rib cage frame.
- Place the L (yellow) electrode under the patient's left clavicle, at the mid-clavicular line within the rib cage frame.
- Place the F (green) electrode on the patient's lower left abdomen within the rib cage frame.
- Place the N (black) electrode on the patient's lower right abdomen within the rib cage frame.
- Place the C (white) electrode in one of the C-lead (C1 to C6) positions depicted in the following section.

9.5.3.5 Lead Placement: Standard 6-wire Lead Sets

A 6-wire lead set can monitor eight ECG vectors (I, II, III, aVR, aVL, aVF, Vx, and Vy) simultaneously. The recommended 6-wire lead placement is as follows.

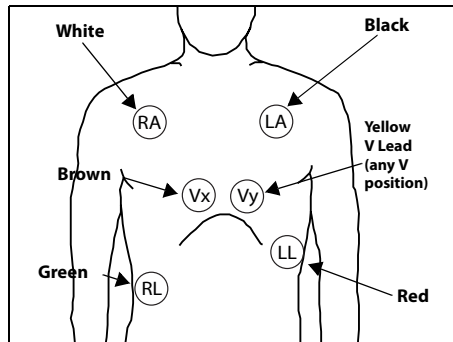

FIGURE 9-11 6-wire Lead Placement (AHA)

- Place the RA (white) electrode under the patient's right clavicle, at the mid-clavicular line within the rib cage frame.
- Place the LA (black) electrode under the patient's left clavicle, at the mid-clavicular line within the rib cage frame.
- Place the LL (red) electrode on the patient's lower left abdomen within the rib cage frame.
- Place the RL (green) electrode on the patient's lower right abdomen within the rib cage frame.
- Place the Vx (brown) electrode in one of the V-lead positions (V1 to V6) depicted in the following section.
- Place the Vy (yellow) electrode in one of the V-lead positions (V1 to V6) depicted in the following section.

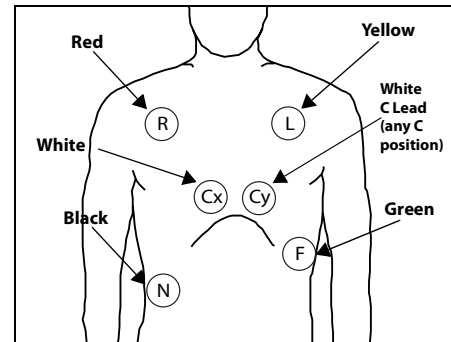

FIGURE 9-12 6-wire Lead Placement (IEC)

- Place the R (red) electrode under the patient's right clavicle, at the mid-clavicular line within the rib cage frame.
- Place the L (yellow) electrode under the patient's left clavicle, at the mid-clavicular line within the rib cage frame.
- Place the F (green) electrode on the patient's lower left abdomen within the rib cage frame.
- Place the N (black) electrode on the patient's lower right abdomen within the rib cage frame.
- Place the Cx (white) electrode in one of the V-lead positions (V1 to V6) depicted in the following section.
- Place the Cy (white) electrode in one of the C-lead (C1 to C6) positions depicted in the following section.

9.5.3.6 Lead Placement: Lead II Monitoring

The recommended lead placement for Lead II monitoring is as follows.

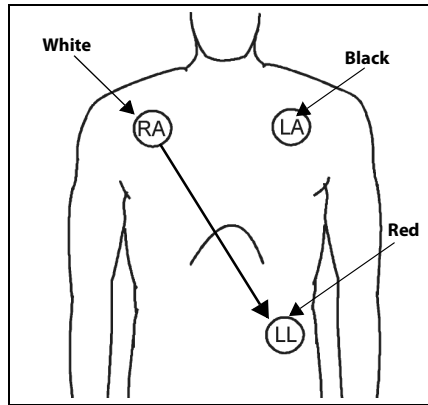

FIGURE 9-13 Lead II Monitoring (AHA)

- Place the RA (white) electrode under the patient's right clavicle, at the mid-clavicular line within the rib cage frame.
- Place the LA (black) electrode under the patient's left clavicle, at the mid-clavicular line within the rib cage frame.
- Place the LL (red) electrode on the patient's lower left abdomen within the rib cage frame.

Select ECG Lead II on the monitor. Lead II is the direct electrical line between the RA (white) electrode and the LL (red) electrode.

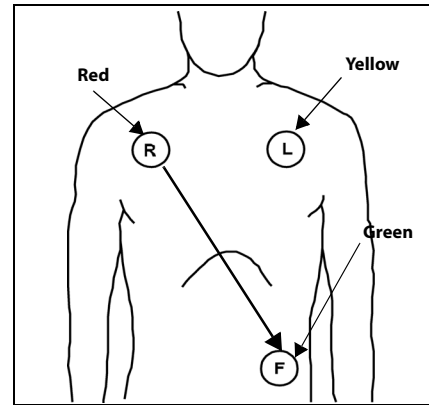

FIGURE 9-14 Lead II Monitoring (IEC)

- Place the R (red) electrode under the patient's right clavicle, at the mid-clavicular line within the rib cage frame.
- Place the L (yellow) electrode under the patient's left clavicle, at the mid-clavicular line within the rib cage frame.
- Place the F (green) electrode on the patient's lower left abdomen within the rib cage frame.

Select ECG Lead II on the monitor. Lead II is the direct electrical line between the R (red) electrode and the F (green) electrode.

9.5.3.7 Lead Placement: Modified Chest Lead (MCL) Monitoring

- The recommended lead placement for MCL monitoring is as follows.

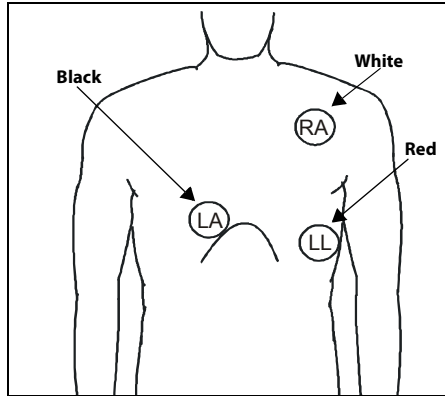

FIGURE 9-15 MCL Monitoring with a 3-wire Lead Set (AHA)

- Place the RA (white) electrode under the patient's left clavicle, at the mid-clavicular line within the rib cage frame.
- Place the LA (black) electrode on the right sternal border, at the fourth intercostal space within the rib cage frame.
- Place the LL (red) electrode on the patient's lower left abdomen within the rib cage frame.
- Select ECG Lead I for MCL₁ monitoring. Lead I is the direct electrical line between the RA (white) electrode and the LA (black) electrode.
- Select ECG Lead II for MCL₆ monitoring. Lead II is the direct electrical line between the RA (white) electrode and the LL (red) electrode.

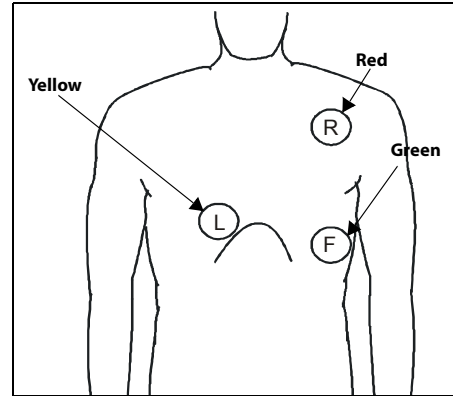

FIGURE 9-16 MCL Monitoring with a 3-wire Lead Set (IEC)

- Place the R (red) electrode under the patient's left clavicle, at the mid-clavicular line within the rib cage frame.
- Place the L (yellow) electrode on the right sternal border, at the fourth intercostal space within the rib cage frame.
- Place the F (green) electrode on the patient's lower left abdomen within the rib cage frame.
- Select ECG Lead I for MCL₁ monitoring. Lead I is the direct electrical line between the R (red) electrode and the L (yellow) electrode.
- Select ECG Lead II for MCL₆ monitoring. Lead II is the direct electrical line between the L (red) electrode and the F (green) electrode.

9.5.3.8 12 Lead ECG

A 12 Lead ECG utilizes a 10-wire ECG lead set that can monitor 12 ECG vectors (I, II, III, aVR, aVL, aVF, V1, V2, V3, V4, V5, and V6) simultaneously. The recommended lead placement for a 12 Lead ECG is as follows.

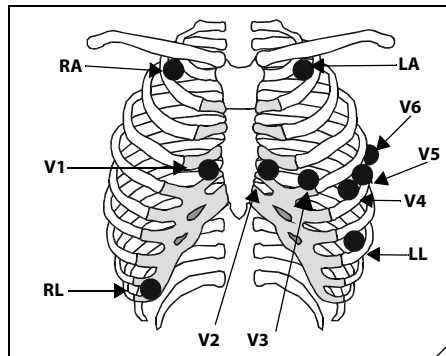

FIGURE 9-17 12 Lead ECG
Lead Placement (AHA)

- Place RA (white) electrode under the right clavicle, mid-clavicular line within the rib cage frame.
- Place LA (black) electrode under the left clavicle, mid-clavicular line within the rib cage frame.
- Place LL (red) electrode on the lower left abdomen within the rib cage frame.
- Place RL (green) electrode on lower right abdomen within the rib cage frame.
- Place V1 (brown) chest lead in the fourth intercostal space, right sternal border.
- Place V2 (brown) chest lead in the fourth intercostal space, left sternal border.
- Place V3 (brown) chest lead midway between V2 and V4 on a straight line.
- Place V4 (brown) chest lead in the fifth intercostal space, mid-clavicular line.
- Place V5 (brown) chest lead in the fifth intercostal space, anterior axillary line.
- Place V6 (brown) chest lead in the fifth intercostal space, mid-axillary line.

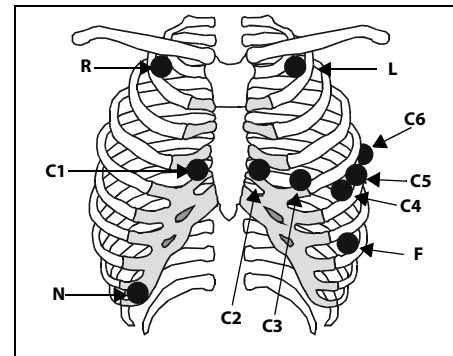

FIGURE 9-18 12 Lead ECG
Lead Placement (IEC)

- Place R (red) electrode under the right clavicle, mid-clavicular line within the rib cage frame.
- Place L (yellow) electrode under the left clavicle, mid-clavicular line within the rib cage frame.
- Place F (green) electrode on the lower left abdomen within the rib cage frame.
- Place N (black) electrode on lower right abdomen within the rib cage frame.
- Place C1 (white) chest lead in the fourth intercostal space, right sternal border.
- Place C2 (white) chest lead in the fourth intercostal space, left sternal border.
- Place C3 (white) chest lead midway between C2 and C4 on a straight line.
- Place C4 (white) chest lead in the fifth intercostal space, mid-clavicular line.
- Place C5 (white) chest lead in the fifth intercostal space, anterior axillary line.
- Place C6 (white) chest lead in the fifth intercostal space, mid-axillary line.

9.5.3.9 Lead Placement: Neonates

Using a 3-wire lead set, ECG lead placement on a neonate is usually directed towards obtaining the best possible respiration data through the ECG thoracic impedance technique. Thoracic impedance is usually measured between the Right Arm and Left Arm electrode patches. These patches should be placed on the chest directly across from each other to optimize the measuring of the neonate's chest movement. The recommended lead placement for neonate monitoring is as follows.

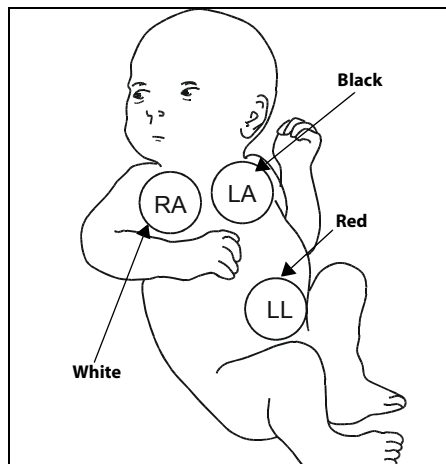

FIGURE 9-19 Neonatal 3-wire Lead Placement (AHA)

- Place the RA (white) electrode under the patient's right clavicle, at the mid-clavicular line within the rib cage frame.
- Place the LA (black) electrode under the patient's left clavicle, at the mid-clavicular line within the rib cage frame.
- Place the LL (red) electrode on the patient's lower left abdomen within the rib cage frame.

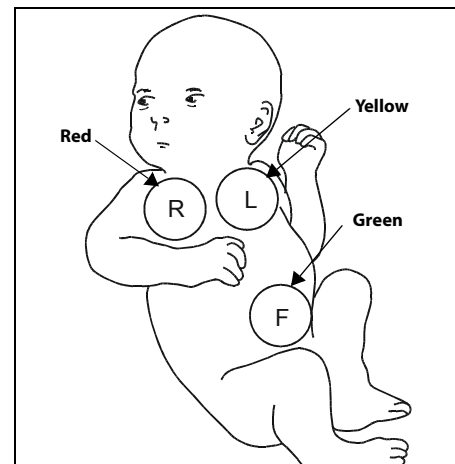

FIGURE 9-20 Neonatal 3-wire Lead Placement (IEC)

- Place the R (red) electrode under the patient's right clavicle, at the mid-clavicular line within the rib cage frame.
- Place the L (yellow) electrode under the patient's left clavicle, at the mid-clavicular line within the rib cage frame.
- Place the F (green) electrode on the patient's lower left abdomen within the rib cage frame.

9.5.3.10 Lead Placement: Pacemaker Patients

The recommended lead placement for monitoring a pacemaker patient is as follows.

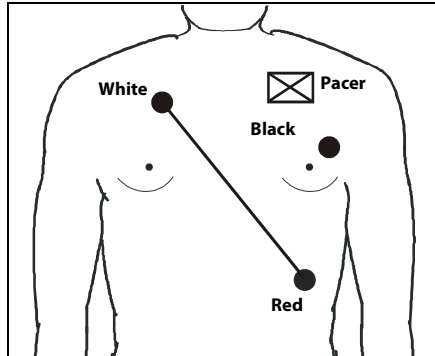

FIGURE 9-21 3-wire Lead Placement for a Pacemaker Patient (AHA)

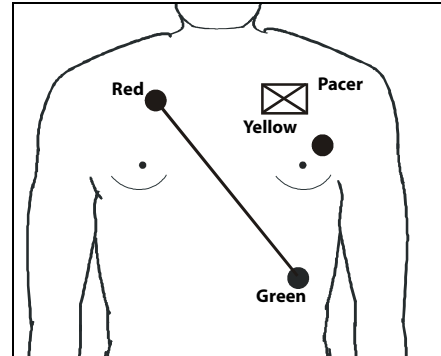

FIGURE 9-22 3-wire Lead Placement for a Pacemaker Patient (IEC)

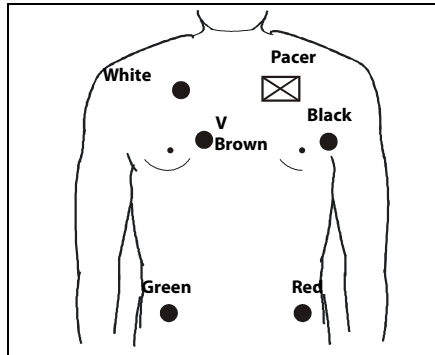

FIGURE 9-23 5-wire Lead Placement for a Pacemaker Patient (AHA)

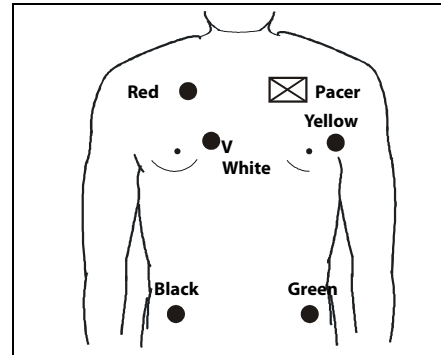

FIGURE 9-24 5-wire Lead Placement for a Pacemaker Patient (IEC)

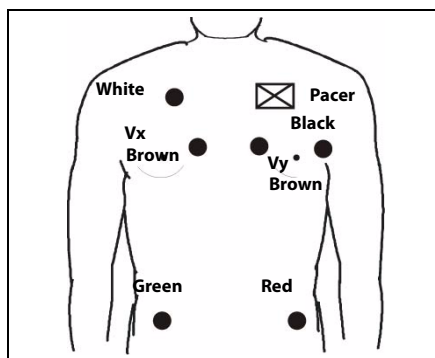

FIGURE 9-25 6-wire Lead Placement for a Pacemaker Patient (AHA)

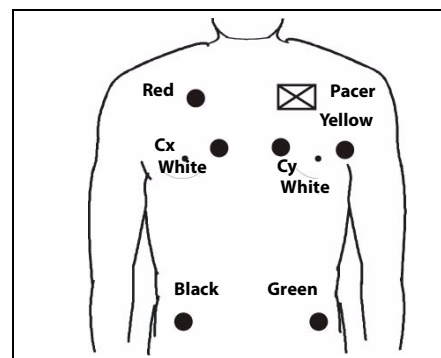

FIGURE 9-26 6-wire Lead Placement for a Pacemaker Patient (IEC)

A pacemaker patient usually requires a different electrode patch placement configuration than a non-pacemaker patient.

Do not place an ECG electrode directly over the pacemaker generator. Place the electrode patches 3 to 5 inches away from the pacemaker generator area. For example, if the pacemaker generator is located in the right subclavian area, relocate the Right Arm electrode closer in towards the center of the chest.

9.6 Arrhythmia Algorithm

The **V 12/V 21** uses an arrhythmia algorithm to monitor ECG waveform data. During the learning phase of the algorithm templates of beats including one for the patient's dominant beats are created. These templates are then used to analyze newly received data. The algorithm verifies that data is free from noise and artifact, and that it does not deviate from the patient's normal ECG rhythms.

A normal ECG waveform typically includes consistent spacing between R waves, a sharp and well defined QRS complex, and an ECG baseline that is free of noise and artifact.

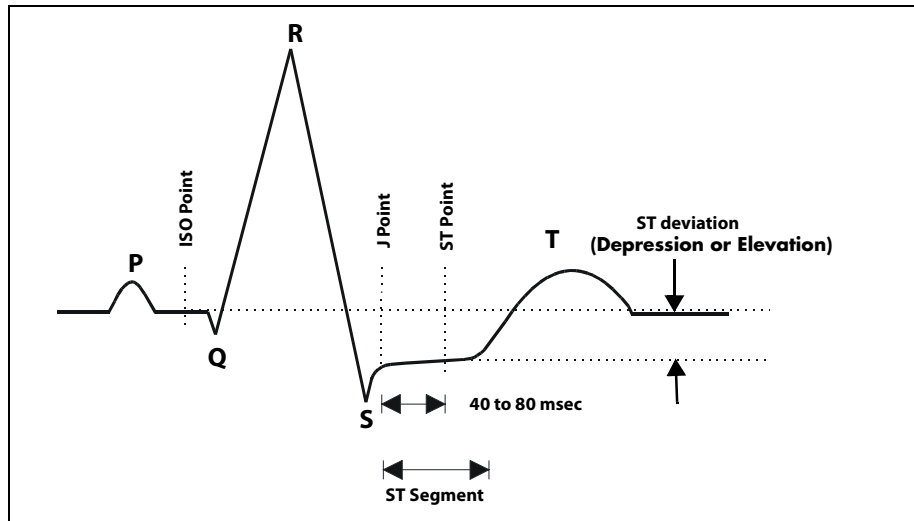

FIGURE 9-27 Example Waveform

9.6.1 Noise and Artifact

The presence of noise or artifact in an ECG waveform makes the accurate detection and classification of heart beats difficult. To best optimize performance, all leads should be free of noise.

Some of the causes of ECG noise include poor skin preparation, improperly attached electrodes, dried electrode gel, defective lead wires, and patient movement. The algorithm uses several techniques to differentiate a patient's QRS complexes from noise sources.

If noise levels are too high for a particular lead, a message is posted, and the data is dropped from analysis until the signal quality is re-established.

If noise levels are too high, the following will occur until the signal quality is re-established:

- Beat detection is suspended
- All rhythm calls are suspended
- An **ECG Noise** message is displayed

9.6.2 Heart Rate Meter

Heart Rate is computed using the 16 most recent R-R intervals for heart rates above 48 beats per minute. If the heart rate calculated using the last 4 beats is less than 48 beats per minute, then this rate is used. All detected beats are used to compute the heart rate. A separate ventricular rate is used in the algorithm to determine rhythms like ventricular tachycardia and ventricular run.

9.6.3 Filtering Pacer Signals

In order to prevent pacer pulses from being mistaken for QRS complexes, they are removed from the ECG data that is sent to the arrhythmia algorithm for analysis. Pacer pulses are shown on the **V 12/V 21** as exaggerated vertical lines.

9.6.4 ECG Amplitude

The minimum threshold for QRS detection algorithm is fixed between 0.15 and 0.45 mV to avoid detecting noise spikes or P-waves as valid beats. Changing the display gain on the monitor does not affect the amplitude of signal that is used by the algorithm for beat detection. For optimal performance, the leads selected for monitoring should have amplitudes of 0.5 to 1 mV or more.

9.6.5 Learning

The process of learning is used to establish a dominant beat template for a patient. The learning period is dependent on the heart rate and the dominant pattern. Learning should not be initiated during a primarily ventricular rhythm because an ectopic beat may be established as normal.

A learn should be initiated when beats are not being properly detected, or when they are being erroneously classified. However, if a signal is not strong enough, or lead data is extremely noisy, better signal quality must be established before a learn can be effective.

9.6.6 Beat Detection and Typing

The following table describes the leads that are used to measure beat detection and beat typing.

DESCRIPTION	3-WIRE LEAD SET	5, 6, 12-WIRE LEAD SETS
Leads used for Beat Detection	Determined by viewed lead	II and V
Leads used for Beat Typing	Determined by viewed lead	II, V, and I
Leads used for V-Fib Detection	Determined by viewed lead	II and V

Once a beat has been detected, the search for the next beat begins after a refractory period to avoid detecting T- waves as valid QRS complexes. For all patient sizes, the minimum QRS amplitude that can be detected is between 0.15 and 0.45 mV depending on the width of the QRS complexes.

Beat typing aligns and compares each new heart beat to reference templates that were previously stored in the system. A beat typing algorithm classifies the beats.

- If an incoming beat matches a template that has already been classified, it is given the same label as the template. The template parameters are updated with the features from this new beat.

The real time ECG analysis library incorporates ventricular ectopic beat detection as a part of arrhythmia analysis.

9.7 Arrhythmia Alarms

Arrhythmia alarms are activated based on the patterns in the patient ECG waveform rhythms. Beat detection for a 5, 6, or 12-lead wire set is determined by using a combination of leads II and V. When using a 3-lead wire set, beat detection is determined by using the lead being viewed.

The following lethal and non-lethal arrhythmia alarms may be detected by the arrhythmia algorithm.

NOTE: Arrhythmia alarms are not available for the Neonate patient size.

9.7.1 Lethal Arrhythmia Alarms

A lethal arrhythmia is an arrhythmia that can be life threatening to a patient if left untreated. Ventricular Tachycardia (V-Tach), Ventricular Fibrillation (V-Fib), and Asystole alarms are classified as lethal arrhythmia alarms. These alarms automatically default to a High alarm level.

NOTE: Lethal arrhythmia alarms are latched alarms. Latching indicates that even after resolving the alarming condition, the alarm continues until it is acknowledged by pressing the SILENCE or SILENCE ALL key on the Navigator Area. If the alarm is acknowledged while the lethal condition still exists, the audio portion of the alarm is silenced for the configured duration, but the alarm message remains in message area. If a new lethal condition occurs while the initial lethal alarm is silenced, the new lethal alarm breaks through if the SILENCE button was selected. If the SILENCE ALL button was selected, the lethal alarm will not break through until the configured duration is expired. If the lethal condition is resolved while the alarm is silenced, the alarm terminates.

9.7.1.1 Asystole Alarm

An **Asystole** alarm is activated when no QRS complexes are detected for the configured time period in the absence of Ventricular Fibrillation.

The time period range for an **Asystole** alarm is user selectable from 3 to 10 seconds.

The Asystole alarm is a High level alarm that produces:

- High level visual and audio alarm indicators.
- An **Asystole** text message above the primary waveform area.

9.7.1.2 Ventricular-Fibrillation (V-Fib) Alarm

A **V-Fib** alarm is activated when a fibrillated waveform (P, QRS or T waves can no longer be identified) is detected. V-Fib is defined as “irregular, disorganized electrical activity of the heart”. The V-Fib detection algorithm runs in parallel to the beat detection algorithm and continuously examines the incoming data.

The V-Fib alarm is a high level alarm that produces:

- High level visual and audio alarm indicators.
- A **Ventricular Fibrillation** message above the primary waveform area.

9.7.1.3 Ventricular Tachycardia (V-Tach) Alarm

A **V-Tach** alarm is activated when the following conditions are met:

- The V-Tach rate is between 100 to 180 or more beats per minute.

AND

- The V-Tach lethal arrhythmia alarm is activated when the configured number of consecutive PVCs is reached. The range for the V-Tach threshold is 3 to 15 beats per minute.

A **V-Tach** alarm is a high level alarm that produces:

- High level visual and audio alarm indicators.
- A **Ventricular Tachycardia** text message above the primary waveform area.

9.7.2 Non-Lethal Arrhythmia Alarms

A Non-Lethal Arrhythmia is an arrhythmia that is most likely not life threatening to a patient. The following are classified as non-lethal arrhythmia alarms:

- Bigeminy
- Bradycardia (Brady)
- Couplet
- Irregular HR
- Pause
- Multiform PVC
- PVCs/minute
- Pauses/Minute
- Run
- Trigeminy
- Ventricular Rhythm (V-Rhythm)
- R-On-T PVC

NOTE: **Non-lethal arrhythmia alarms are not latched alarms and can be acknowledged at any time. To acknowledge a non-lethal arrhythmia alarm, press the SILENCE or SILENCE ALL key in the Navigation Area.**

9.7.2.1 Bigeminy

The **Bigeminy** alarm is activated when three or more cycles of one PVC coupled to one normal beat are detected.

The Bigeminy default alarm is a **Low** level alarm event that produces:

- Low level visual and audio alarm indicators.
- A **Bigeminy** text message above the primary waveform area.

9.7.2.2 Bradycardia (Brady)

The **Brady** alarm is activated when the heart rate falls to a value 10% lower than the user selected value for low heart rate alarm.

The **Brady** default alarm is a **High** level alarm event that produces:

- High level visual and audio alarm indicators.
- A **Bradycardia** text message above the primary waveform area.

9.7.2.3 Couplet

The **Couplet** alarm is activated when two consecutive PVCs are detected between normal beats.

The Couplet default alarm is a **Low** level alarm event that produces:

- Low level visual and audio alarm indicators.
- A **Couplet** text message above the primary waveform area.

9.7.2.4 Irregular HR

The **Irregular HR** alarm is activated when the measured variations in the R-R interval over a period of time exceeds a preset limit established by the arrhythmia algorithm.

The Irregular HR default alarm is a **Low** level alarm event that produces:

- Low level visual and audio alarm indicators.
- An **Irregular HR** text message above the primary waveform area.

9.7.2.5 Pause

The Pause alarm is activated when no beats are detected during 1.8 times or more of the current R-R interval and the next beat is NOT a PVC.

The Pause default alarm is a **Medium** level alarm event that produces:

- Medium level visual and audio alarm indicators.
- A **Pause** text message above the primary waveform area.

9.7.2.6 Multiform PVC

The **Multiform PVC** alarm is activated when over the last 15 beats two or more ventricular beats with different morphologies are detected and no V-Tach, V-Rhythm, or V-Fib are detected.

The Multiform PVC default alarm is a **Low** level alarm event that produces:

- Low level visual and audio alarm indicators.
- A **Multiform PVC** text message above the primary waveform area.

9.7.2.7 PVCs/minute

The **PVCs/minute** alarm is activated when the number of PVCs detected per minute exceeds the configured threshold. The PVC limit can be set to 1 to 30 PVCs per minute.

The PVCs/minute default alarm is a **Low** level alarm event that produces:

- Low level visual and audio alarm indicators.
- A **PVCs/Minute** text message above the digital tile.

NOTE: During periods of Ventricular Rhythms, V-Tach, V-Fib and Asystole, PVCs/minute are not shown.

9.7.2.8 Pauses/Minute

The **Pauses/Minute** alarm is activated when the number of pauses detected per minute exceeds the configured threshold. The Pauses/Minute limit can be set to 1 to 15 Pauses per minute.

The Pauses/Minute default alarm is a **Medium** level alarm event that produces:

- Medium level visual and audio alarm indicators.
- A **Pauses/Minute** text message above the digital tile.

9.7.2.9 Run

The **Run** alarm is activated when the number of consecutive PVCs occur at a rate that equals or exceeds the user defined V-Tach Rate. The number of consecutive PVCs that constitute a Run is one beat less than the minimum used to identify V-Tach.

The Run default alarm is a **Medium** level alarm event that produces:

- Medium level visual and audio alarm indicators.
- A **Run** text message above the ECG1 waveform area.

9.7.2.10 Trigeminy

The **Trigeminy** alarm is activated when three or more cycles of one PVC coupled to two normal beats are detected. This rhythm could also cause an Irregular HR alarm.

The Trigeminy default alarm is a **Low** level alarm event that produces:

- Low level visual and audio alarm indicators.
- A **Trigeminy** text message above the primary waveform area.

9.7.2.11 Ventricular Rhythm (V-Rhythm)

The **V-Rhythm** alarm is activated when more than two (2) consecutive PVCs occur at a rate that is less than the user defined V-Tach Rate.

The V-Rhythm default alarm is a **Medium** level alarm event that produces:

- Medium level visual and audio alarm indicators.
- A **Ventricular Rhythm** text message above the primary waveform area.

9.7.2.12 R-On-T PVC

The **R-On-T PVC** alarm is activated when the following occurs:

- A beat is detected as a PVC and previous beat is not a PVC and
- Current BTB heart rate is > 120 bpm and
- Current RR-interval is < previous RR-interval

The **R-On-T PVC** default alarm is a **Medium** level alarm event that produces:

- Medium level visual and audio alarm indicators.
- A **R-On-T PVC** text message above the primary waveform area.

9.8 ST Segment Analysis

The ST segment of an ECG waveform (as shown in FIGURE 9-27) represents the period from the end of ventricular de-polarization, to the beginning of ventricular re-polarization, or the end of the QRS complex (the J point) and the beginning of the T-wave. ST Segment analysis is used to monitor the oxygen supply and the viability of the heart muscle.

ST deviation is the vertical distance between the isoelectric (ISO) point level and signal level at ST point.

The ISO point is located between the end of the P-wave and the onset of the QRS complex. The ISO point provides the baseline for this measurement.

The ST point is a fixed distance from the J point at the end of the QRS complex. The ST point can be configured to 40, 60, or 80 milliseconds past the J-point, independent of the heart rate. By default, the ST point is positioned as follows:

- at 80 milliseconds for heart rates less than or equal to 120 beats per minute
- at 60 milliseconds for heart rates greater than 120 beats per minute

ST segments are typically calculated on graph paper with a scale of 1cm/mV, and measured in millimeters where one millimeter is equivalent to 0.1 mV. The reliability of ST measurements is lowered with the presence of atrial fibrillation, flutter, and erratic baseline changes.

Selecting leads that contain the least amount of baseline flutter will improve measurement accuracy, but accurate ST deviation measurement is dependent on the correct location of the ISO and ST points.

All available ECG leads are analyzed to measure deviations in the ST segment.

The displayed ST data is updated approximately every 10 seconds.

9.8.1 Learning

The process of learning is used to establish normal beat templates or a stable baseline for accurate ST analysis. To establish this baseline, the system evaluates the first sixteen normal beats based on readings from leads II, V, and I.

To establish an accurate baseline, it is recommended that learning be done when the patient is in stable condition, not moving, and has an ECG rhythm that is free of artifact. Learning should not be initiated during a primarily ventricular rhythm or other ECG rhythm irregularity because an ectopic beat may be established as normal.

Learning automatically occurs when:

- Arrhythmia analysis is turned on
- ST analysis is turned on
- Patient monitoring resumes and patient is removed from the standby mode
- A 3-wire lead set is in use and the current ECG lead is changed

9.8.2 ECG Filters

The ST segment of an ECG waveform often contains low amplitude signals with low frequency content. To preserve low frequency signal content, the high pass filter is set to 0.05 Hz when ST analysis is turned on.

TABLE 9-3

FILTER SETTING	FILTER BANDWIDTH	PURPOSE
Monitor	0.5 Hz to 40 Hz	Used for routine cardiac rhythm monitoring. Limits display of artifact and baseline wander due respectively to power line interference and patient movement. Unless intentionally set otherwise, the Monitor filter is selected by default.
ST	0.05 Hz to 40 Hz	Allows ST segments to be accurately measured. If the Monitor filter is in use when the ST analysis feature is enabled, the V 12/V 21 monitor automatically selects the ST filter.
Diagnostic	0.05 Hz to 150 Hz	This is the widest bandwidth available. Effective for diagnostic examination of ECG wave when patient is not moving. (Patient movement affects the ECG waveform.) The Diagnostic filter may also be used with the ST analysis feature.

9.9 12 Lead Interpretation

The V 12/V 21 supports the 12 Lead Interpretation using the University of Glasgow 12-Lead ECG algorithm. All results of the 12 Lead interpretation are collected in a report and sent directly to the printer.

This section describes 12 Lead interpretation in detail, including how to configure the **Setup** tab and the **Advanced** tab for 12 Lead, and 12 Lead printing report.

Patient Sizes

Intended patient types: Adult, Pediatric, Neonate.

9.9.1 12 Lead Dialog

The 12 Lead dialog (as shown in FIGURE 9-28) contains a **Setup** tab and an **Advanced** tab. A description of each tab follows.

9.9.1.1 Navigating to the 12 Lead Interpretation Dialog

1. Select the **Procedures** tab from the Navigation Area.
2. Select the **12 Lead** button.

NOTE: The **12 Lead** button is only available in the **Procedures** tab when **12 Lead** is selected from the **ECG Cable Type** button on the **ECG Setup** tab.

OR

1. Select the **Setup** tab from the Navigation Area.
2. Select the **Parameters** button.
3. Select the **12 Lead** button.
The 12 Lead dialog displays (as shown in FIGURE 9-28).

The screenshot shows the '12 Lead' dialog box with the 'Setup' tab selected. The dialog contains the following fields and controls:

- Physician:** APPLE
- Technician:** ORANGE
- Gender:** Male
- Race:** Asian
- Drug:** Digitalis
- Clinical Classification:** Cardiomyopathy
- Date of Birth:** 2000 (Year), January (Month), 12 (Day)
- Age:** (Empty field)
- Buttons:** Print 12 Lead, Cancel, Accept

FIGURE 9-28 Example 12 Lead Dialog (Setup Tab)

9.9.1.2 Configuring 12 Lead Setup

1. Select the **Procedures** tab from the Navigation Area.
2. Select the **12 Lead** button. By default, the **Setup** tab is selected.
3. Select the applicable buttons to begin entering or editing. Refer to TABLE 9-4 for a description of each button.

TABLE 9-4

BUTTON	DESCRIPTION	CHOICES*
Physician	Select to enter or change the physician name. Factory default is a blank value.	None
Technician	Select to enter or change the Technician name. Factory default is a blank value.	None
Gender	Select to enter or change patient gender.	Unspecified , Male, Female
Race	Select to enter or change patient race.	Caucasian, Asian, Black, Other, Undefined
Drug	Configure which drug the patient uses.	Unknown , No Medication, Digitalis, Diuretic, Beta Blocker, Quinidine, Procainamide, Amiodarone, Disopyramide, Lignocaine, Other Anti-Arrhythmics, Psychotropic, Steroid, and Other Medication
Clinical Classification	Configure a classification which is part of the patient's known history.	Unknown , None, Myocardial Infarction, Myocardial Ischemia, Hypertension, Congenital Heart Disease, Valvular Heart Disease, Pericarditis, Respiratory Disease, Endocrine Disease, Implanted Pacemaker, Pulmonary Embolism, Post Operative Cardiac Surgery, Other, and Cardiomyopathy
Year	Select to enter or change the patient's year of birth. Factory default is a blank value.	None
Month	Select to enter or change the patient's month of birth. Factory default is a blank value.	None
Day	Select to enter or change the patient's date of birth. Factory default is a blank value.	None
Age	Auto calculate and display the patient's age according to the patient's date of birth.	None

* *The factory default configuration settings are in bold.*

4. Select the **Cancel** or **Accept** button.
 - The **Cancel** button closes the dialog without saving the settings.
 - The **Accept** button saves the settings and closes the dialog.

9.9.1.3 Configuring 12 Lead Advanced Setup

1. Select the **Procedures** tab from the Navigation Area.
2. Select the **12 Lead** button.

3. Select the **Advanced** tab (as shown in FIGURE 9-29).



FIGURE 9-29 Example 12 Lead Dialog (Advanced Tab)

4. Select the buttons described in TABLE 9-5 to configure the tab.

TABLE 9-5

BUTTON	DESCRIPTION	CHOICES*
QTC Formula	Configure the formula used in calculating the QTC.	Hodges , Bazett, Fridericia, and Framingham For details about QTC formulas, refer to the <i>Glasgow Program Physician's Guide</i> (P/N 046-004985-00)
Waveform Layout	Configure the waveform layout.	Standard and Cabrera
Report Format	Configure the report format.	Standard , Median Complexes and Matrix
Speed	Configure the 12 Lead ECG sweep speed.	25 mm/sec and 50 mm/sec
Size	Configure the 12 Lead ECG gain.	0.5 cm/mV, 1 cm/mV , and 2 cm/mV
Tachycardia	Configure the 12 Lead tachycardia threshold.	80 to 130 bpm The factory default value is 100 bpm.
Bradycardia	Configure the 12 Lead Bradycardia threshold.	40 to 60 bpm The factory default value is 50 bpm.
V3 Placement	Configure the V3 placement	Standard and V4R

*The factory default configuration settings are in bold.



5. Select the **Cancel** or **Accept** button.
- The **Cancel** button closes the dialog without saving the settings.
 - The **Accept** button saves the settings and closes the dialog.

9.9.2 12 Lead Report

Select the **Print 12 Lead** button to print the 12 Lead report. Refer to "12 Lead Report" on page 19-11 for additional information.

9.10 ECG-Arrhythmia Troubleshooting

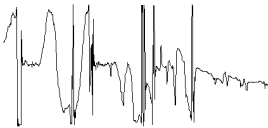
The Arrhythmia tile ECG waveform area displays messages indicating the current state of the Arrhythmia and ECG parameter. If there is more than one message to display, the messages scroll.

MESSAGE/PROBLEM	REASON	SOLUTION
Noisy ECG traces 	Loose or dry electrodes.	Apply fresh, moist electrodes.
	Defective electrode wires.	Replace wires as necessary.
	Patient cable or leads are routed too close to other electrical devices.	Eliminate 50-60 Hz interference.
Excessive Electro-surgical Interference	Wrong ECG cable used.	Use ESIS ECG cable with internal filter block. NOTE: Respiration monitoring via the ECG electrodes will not be available when using the cable.
Muscle Noise 	Inadequate skin preparation prior to application of electrode, tremors, tense subject, and/or poor electrode placement.	Repeat skin preparation and electrode location procedures. Apply fresh, moist electrodes. Avoid areas of the torso that are very muscular.
	Intermittent Signal	Connections not tight and/or properly secured.
Excessive alarms: heart rate, lead fault	Electrodes dry or loose.	Re-prep skin and apply fresh, moist electrodes.
	Cable or lead wires damaged.	Change cable and lead wires.
	Electrodes dry.	Re-prep skin and apply fresh, moist electrodes.
	Alarm limits set too close to patient's normal heart rate.	Readjust.
Low Amplitude ECG Signal	R-wave wrong size.	Must have a higher amplitude than the other ECG waves, like the P and T waves.
	Excessive patient movement or muscle tremor.	Reposition electrodes and secure with tape, if necessary.
	Gain set too low.	Readjust as required - (Set via the Waveforms tab).
	Electrodes dry / old.	Apply fresh, moist electrodes.
	Skin improperly prepared.	Abrade skin.
No ECG Waveform	This could be the patient's normal QRS complex.	Verify with a 12-lead electro-cardiogram.
	Electrode could be positioned over a bone or muscle mass.	Move ECG patches away from the bone or muscle mass.
	Gain set too low.	Readjust as required.
No ECG Waveform	Lead wires and patient cable not fully or properly inserted.	Check for proper insertion.
	Cable or lead wires damaged.	Change cable and lead wires.

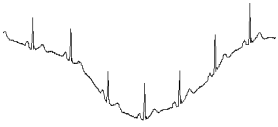
MESSAGE/PROBLEM	REASON	SOLUTION
Base Line Wander 	Patient moving excessively.	Secure lead wires and cable to patient.
	Patient's respiration.	Reposition electrodes.
	Electrodes dry or loose.	Re-prepare skin and apply fresh, moist electrodes.
	Static build up around patient.	Check with local biomedical personnel.
	ECG Filter set to ST or Diagnostic mode.	Set ECG Filter to "Monitor" mode.

Respiration (Resp)

Introduction	10-2
Resp Dialog.....	10-2
Respiration Tile Layouts	10-7
Respiration Troubleshooting	10-9

10.1 Introduction

This chapter describes the Resp parameter in detail including how to configure Resp alarm limits, enabling/disabling respiration, and how to configure the Resp parameter.

Respirations, or the amount of breaths per minute, are measured using two (2) methods:

- Thoracic impedance via ECG
- CO₂ exchange via Microstream[®] CO₂

The first method is thoracic impedance through the ECG signal. The respiration signal is measured between two ECG electrodes:

- RA and LA of ECG Lead I, or
- RA and LL of ECG Lead II

The second is by CO₂ exchange via internal CO₂ module. Refer to "CO₂ Monitoring (Optional)" on page 17-1 for additional information.

NOTE: **The respiration source is automatic. When the CO₂ parameter is detected, the system automatically uses CO₂ as the source for respiration. When CO₂ is not present, ECG is automatically used as the respiration source.**

Patient Sizes

Intended patient types: Adult, Pediatric, Neonate.

VPS

The VPS module supports the Respiration parameter when ECG is the respiration source.

Display Setup

To see the Resp values, Resp must be configured to display on the Main Screen. Refer to "Display Options Dialog" on page 3-2 for additional information.

10.2 Resp Dialog

The Resp dialog (as shown in FIGURE 10-1) contains an **Alarms** tab, **Setup** tab, **Waveform** tab and an **Apnea** tab. A description of each tab follows.

10.2.1 Navigating to the Resp Dialog

- Select the Resp digital or waveform tile.

OR

1. Select the **Setup** tab from the Navigation Area.
2. Select the **Parameters** button.
3. Select the **Resp** button.
The **Resp** dialog displays (as shown in FIGURE 10-1).

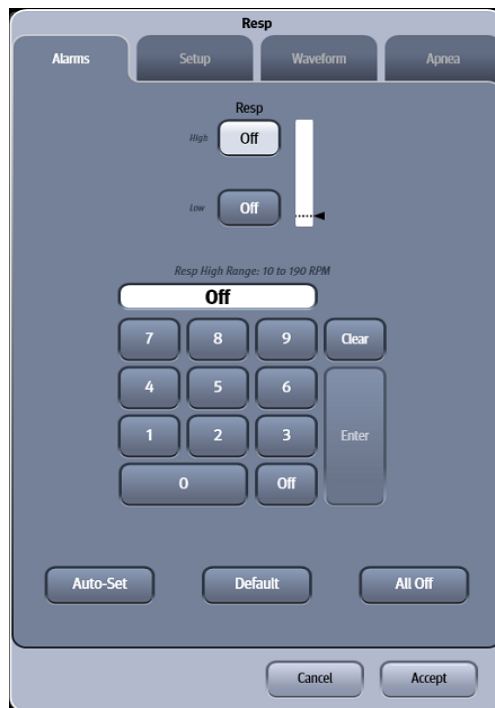

FIGURE 10-1 Example Resp Dialog (Alarms Tab)

10.2.2 Configuring Resp Alarm Limits

Refer to "Configuring Alarm Limits" on page 8-2 for additional information.

10.2.3 Configuring the Resp Parameter

1. Select the Resp digital or waveform tile.
2. Select the **Setup** tab (as shown in FIGURE 10-2).

NOTE: The current parameter setting displays in bold to the right of the each button.

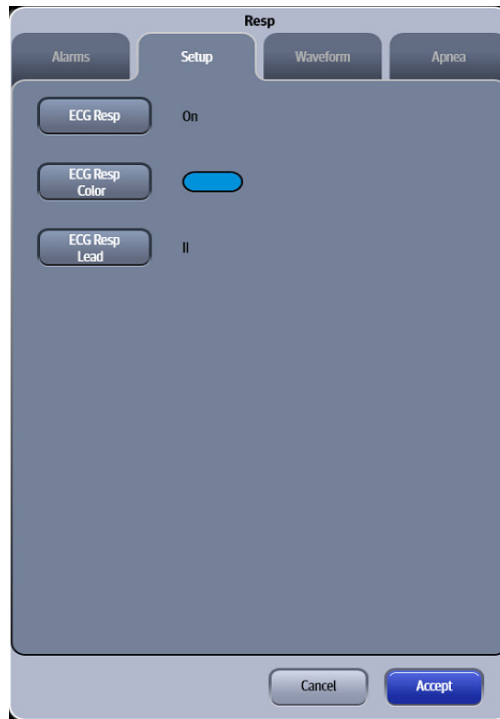

FIGURE 10-2 Example Resp Dialog (Setup Tab)

3. Select the buttons described in TABLE 10-1 to configure the tab.

TABLE 10-1

BUTTON	DESCRIPTION / COMMENTS	CHOICES*
ECG Resp	Configures whether respiration is enabled or disabled.	On , Off
ECG Resp Color	Configures the Resp parameter digital tile and waveform color.	16 distinct colors Default color is blue .
ECG Resp Lead	Configures which lead the respiration parameter uses to calculate the measurement when ECG is the respiration source.	Lead I, and II

* *The factory default configuration settings are in bold.*

4. Select the **Cancel** or **Accept** button.
 - The **Cancel** button closes the dialog without saving the settings.
 - The **Accept** button saves the settings and closes the dialog.

10.2.4 Configuring the Resp Waveform

1. Select the Resp digital or waveform tile.
2. Select the **Waveform** tab (as shown in FIGURE 10-3).

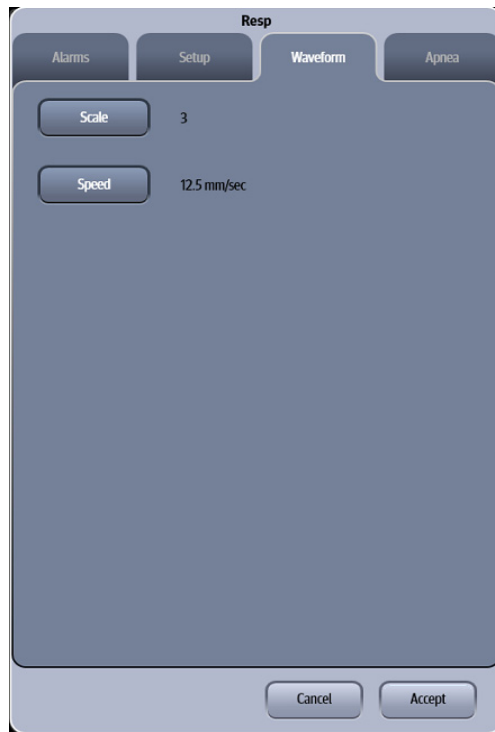

FIGURE 10-3 Example Resp Dialog (Waveform Tab)

3. Select the buttons described in TABLE 10-2 to configure the tab.

TABLE 10-2

FUNCTION	DESCRIPTION	SETTINGS*
Scale	Configures the Resp waveform gain.	1, 2, 3 , 4 and 5
Speed	Configures the Resp waveform speed.	3.125 mm/sec, 6.25 mm/sec, 12.5 mm/sec , 25 mm/sec

* *The factory default configuration settings are in bold.*

4. Select the **Cancel** or **Accept** button.
 - The **Cancel** button closes the dialog without saving the settings.
 - The **Accept** button saves the settings and closes the dialog.

10.2.5 Configuring Apnea Alarms

1. Select the Resp digital or waveform tile.
2. Select the **Apnea** tab (as shown in FIGURE 10-4).

NOTE: The Apnea alarm options in the Resp dialog are only enabled in the dialog when Apnea Alarms are unlocked in the System Setup Alarms tab. Refer to "Configuring the Printer Tab" on page 25-9 for additional information.

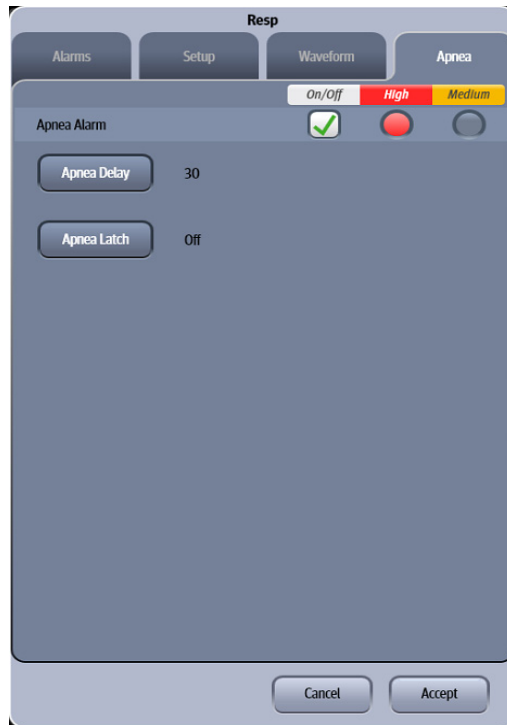

FIGURE 10-4 Example Resp Dialog (Apnea Tab)

3. Select the buttons described in TABLE 10-3 to configure the tab.

TABLE 10-3

FUNCTION	DESCRIPTION	SETTINGS*
Apnea Alarm	Configures whether the apnea alarm is on or off.	On, Off
Apnea Delay	Configures the number of seconds before the apnea alarm is called.	Adult: 10-60 seconds, 30 Pediatric: 10-20 seconds, 15 Neonate: 10-20 seconds, 15
Apnea Latch	Configures whether the apnea alarm is latched or unlatched. Refer to "Apnea Latching" on page 7-3 for additional information.	On, Off
NOTE:		When the patient size is Neonate, the Apnea Latch default setting is On.

* The factory default configuration settings are in bold.

4. Select the **Cancel** or **Accept** button.
 - The **Cancel** button closes the dialog without saving the settings.
 - The **Accept** button saves the settings and closes the dialog.

10.3 Respiration Tile Layouts

The Respiration parameter is shown in a digital and a waveform tile layout.

10.3.1 Respiration Digital Tile Layout

The Resp digital tile displays:

1. Message area
2. Unit of measure
3. Respiration source
4. Respiration value
5. High and low alarm limits

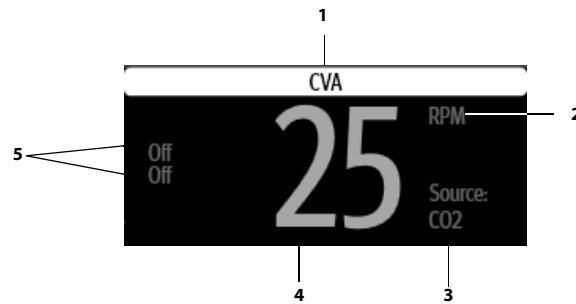

FIGURE 10-5 Example Resp Digital Tile

10.3.2 About the Resp Tile

- The Resp tile displays all respiration in units of **RPM** with a resolution of 1 RPM.
- If the measurement is invalid, "--" displays in place of digits.
- Displays all non-alarming text in the configured respiration color when the respiration source is ECG.
- Displays all non-alarming text in the configured CO₂ color when the respiration source is CO₂.
- Replaces the digital value with an **Apnea** message when an apnea alarm condition exists.

10.3.3 Resp Alarms

Refer to the "Factory Default Alarm Limits" on page 8-4 for additional information.

10.3.4 Message Area

The message area provides information about the current state of the Resp parameter. If there is more than one message to display, the messages scroll.

MESSAGE	DETAILS
Resp High Alarm Violation	Indicates that the current value is either equal to or higher than the set alarm limits.
Resp Low Alarm Violation	Indicates that the current value is either equal to or lower than the set alarm limits.
High Impedance - Check Leads	Displays when a high impedance conditions exists.

10.3.5 Respiration Waveform Tile Layout

The Resp waveform tile displays:

1. Tile name
2. Resp waveform
3. Resp waveform size

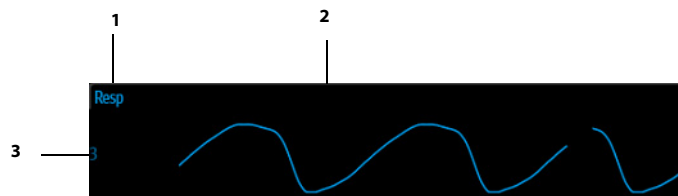

FIGURE 10-6 Example Resp Waveform Tile

10.3.6 About the Resp Waveform Tile

- The Resp waveform tile displays the waveform and the wave gain setting in the configured respiration color.
- Provides a scrolling, real-time waveform and an erase bar to provide a time indicator of oldest and new data.
- The Resp waveform tile rails the top most value when the waveform exceeds the upper scale limit for real-time waveforms.
- The Resp waveform tile rails the bottom most value when the waveform exceeds the lower scale limit for real-time waveforms.
- The Resp waveform tile displays the waveform at the configured waveform sweep speed.

10.4 Respiration Troubleshooting

The Resp tile message area displays messages indicating the current state of the Resp parameter. If there is more than one message to display, the messages scroll.

ISSUE	REASON	SOLUTION
Do not see Resp parameter tiles in display.	Parameter not configured to display.	Refer to "Display Options Dialog" on page 3-2 for additional information.
Resp waveform too large	Scales set inappropriately.	Change lead selection. Change respiration scale.
Resp waveform too small	Patient breathing is shallow or patient is turned on side. Scale set inappropriately.	Change lead selection. Change respiration scale.
False apnea alarm	Apnea delay may be improperly set. Patient may be having frequent episodes of CVA. Scale size may be too low.	Choose another apnea delay. Reposition electrodes to better detect respirations. Change Respiration scale
No Resp waveform or rate displayed in the tile	Resp is turned off. Patient connected using ESIS choke cable. Cable not connected. New ECG lead cable in use at the bedside monitor and ECG Resp lead needs to be changed.	Turn Resp on. Check that proper patient cable is used. Use approved non-ESIS patient cable. Check cable. Change ECG Resp Lead in the Setup dialog.

This page intentionally left blank.

Invasive Blood Pressure (IBP)

Introduction	11-2
IBP Dialog.....	11-3
Measuring IBP	11-7
Measuring ICP	11-8
IBP Tile Layouts.....	11-12
Inserting the PA Catheter.....	11-16
Pulmonary Artery Wedge Pressure (PAWP)	11-17
IBP Troubleshooting.....	11-20

11.1 Introduction

This chapter describes the Invasive Blood Pressure (IBP) parameter in detail, including step-by-step instructions on how to configure alarm limits, rename IBP channels, establish filter settings, configure the IBP waveform scale and speed, and initiate an IBP parameter measurement.

Invasive Blood Pressure (IBP) is a direct measurement of the patient's arterial or venous blood pressure. IBP utilizes a catheter that is inserted directly into a vein, artery or other pressure access areas, and is connected to a transducer for interpretation of Systolic (Sys), Diastolic (Dia), and Mean blood pressures.

The **V 12/V 21** calculates the systolic pressure, diastolic pressure and mean pressure values for each IBP channel. The **V 12/V 21** supports up to eight (8) invasive blood pressures measurements. It provides systolic pressure, diastolic pressure and mean pressure values for each IBP channel.

Patient Sizes

Intended patient types: Adult, Pediatric, Neonate.

VPS Connector

The VPS module supports two (2) IBP connectors (as shown in FIGURE 11-1). Refer to "Measuring IBP" on page 11-7 for additional information.

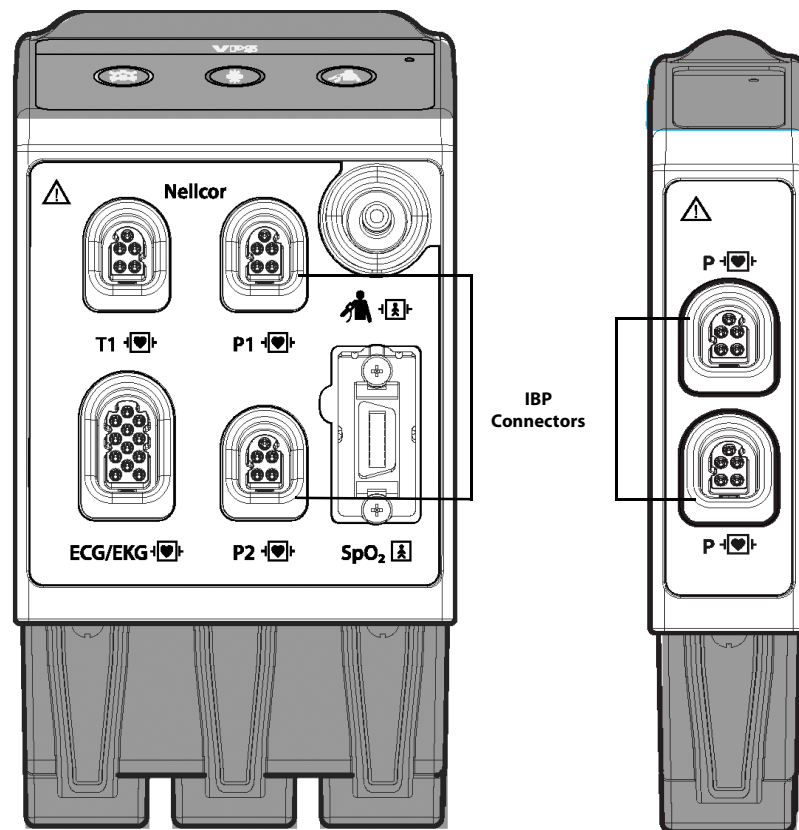

FIGURE 11-1 Example VPS IBP Connectors (VPS on Left, Standalone Module on Right)

Display Setup

To see the IBP values, IBP must be configured to display on the Main Screen. Refer to "Display Options Dialog" on page 3-2 for additional information.

11.2 IBP Dialog

The IBP dialog (as shown in FIGURE 11-2) contains an **Alarms** tab, **Setup** tab, and **Waveform** tab. A description of each tab follows.

11.2.1 Navigating to the IBP Dialog

- Select the IBP digital or waveform tile.

OR

1. Select the **Setup** tab from the Navigation Area.
2. Select the **Parameters** button.
3. Select an **IBP** button.

The **IBP** dialog displays (as shown in FIGURE 11-2).

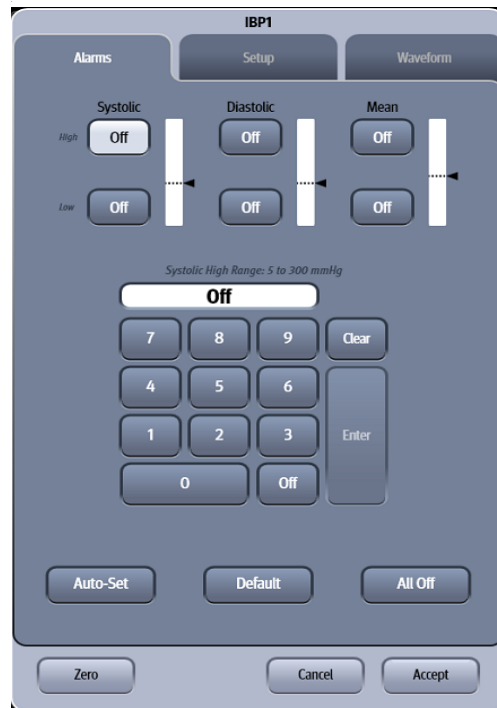

FIGURE 11-2 Example IBP Dialog (Alarms Tab)

11.2.2 Configuring IBP Alarm Limits

Refer to "Configuring Alarm Limits" on page 8-2 for additional information.

11.2.3 Configuring the IBP Parameter

1. Select the IBP digital or waveform tile.
2. Select the **Setup** tab (as shown in FIGURE 11-3).

NOTE: The current parameter setting displays in bold to the right of each button.



FIGURE 11-3 Example IBP1 Dialog (Setup Tab)

3. Select the buttons described in TABLE 11-1 to configure the tab.

TABLE 11-1

BUTTON	DESCRIPTION / COMMENTS	CHOICES*
Label**	Configures the IBP label.	IBPx , ART, ART2, UA, LV, PA, CVP, ICP, IAP, LA, RA
NOTE: When an IBP module is connected or removed, the label information remains.		
Color**	Configures the IBP parameter color.	16 distinct colors Channel 1/ART/ART2/UA/LV: Red Channel 2/PA: Yellow Channel 3/CVP/RA: Blue Channel 4: Green Channel 5- 8/ICP/LA/IAP: White
Filter	Configures the IBP filter frequency for each channel.	8 Hz, 12 Hz, 16 Hz
Display APP	Configures if APP displays in the digital tile.	On , Off
NOTE: This button only displays in the Setup tab when the IBP channel is labeled IAP.		

* The factory default configuration settings are in bold.

** Refer to glossary for acronym definitions

TABLE 11-1

BUTTON	DESCRIPTION / COMMENTS	CHOICES*
Display CePP	Configures if CePP displays in the digital tile.	On , Off

NOTE: This button only displays in the Setup tab when the IBP channel is labeled ICP.

* The factory default configuration settings are in bold.
 ** Refer to glossary for acronym definitions

4. Select the **Cancel** or **Accept** button.
 - The **Cancel** button closes the dialog without saving the settings.
 - The **Accept** button saves the settings and closes the dialog.

11.2.4 Configuring the IBP Waveform

1. Select the IBP digital or waveform tile.
2. Select the **Waveform** tab (as shown in FIGURE 11-4).

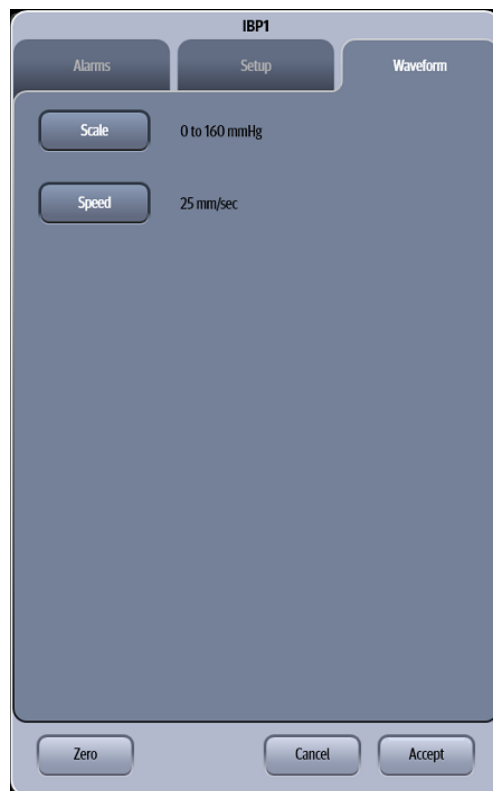

FIGURE 11-4 Example IBP1 Dialog (Waveform Tab)

3. Select the buttons described in TABLE 11-2 to configure the tab.

TABLE 11-2

BUTTON	DESCRIPTION / COMMENTS	CHOICES*
Scale	Configures the waveform height and width.	-10 to 10 mmHg 0 to 20 mmHg 0 to 40 mmHg 0 to 60 mmHg 0 to 80 mmHg 60 to 140 mmHg 0 to 160 mmHg (when labeled an IBP <channel> number) 0 to 225 mmHg 0 to 320 mmHg
Speed	Configures the waveform sweep speed.	6.25 mm/sec. 12.5 mm/sec. 25 mm/sec 50 mm/sec

* *The factory default configuration settings are in bold.*

4. Select the **Cancel** or **Accept** button.
 - The **Cancel** button closes the dialog without saving the settings.
 - The **Accept** button saves the settings and closes the dialog.

11.2.4.1 Default IBP Waveform Sizes

The default IBP waveform size is 0 to 160 mmHg for all of the generic IBP<channel> labels. The other IBP labels also have default waveform sizes. TABLE 11-3 outlines these defaults.

TABLE 11-3

LABEL	DEFAULT WAVEFORM SIZE
ART and ART2	0 to 160 mmHg
UA	0 to 80 mmHg
LV	0 to 160 mmHg
PA	0 to 40 mmHg
CVP	0 to 20 mmHg
ICP	0 to 20 mmHg
LA	0 to 20 mmHg
RA	0 to 20 mmHg
IAP	0 to 20 mmHg

11.3 Measuring IBP

1. Plug the pressure transducer cable into one of the IBP connectors (as shown in FIGURE 11-1).
2. The IBP1 and IBP2 waveforms display with their associated data to the right of the waveforms.

NOTE: **Do not use the arterial pressure catheter on a limb that is being utilized for any other medical procedure. For example, an IV Catheter, NIBP Cuff or an SpO₂ sensor.**

3. Connect catheter line with flushing device to a pressure transducer.
4. Zero pressure transducer as follows:
 - a. Open transducer vent to atmosphere.
 - b. Press the **Zero All IBP** button in Quick Functions menu, or individually zero pressure lines by opening individual IBP Setup dialog.
 - c. Close the pressure transducer vent from atmosphere.

After the automatic zero process is complete, the pressure display should indicate zeros.

5. Select the desired pressure scale in the **IBP Menu**.

NOTE: **Zero and flush the pressure line at regular intervals per standard hospital procedure.**

NOTE: **Pressure transducers are protected against the effects of defibrillation and electro-cautery.**

11.4 Measuring ICP

The VPS module can interface with the Camino Advanced Monitor CAM01 in Adult, Pediatric and Neonatal patients. The Camino measures intracranial pressure (ICP), intracranial temperature (ICT) and calculates cerebral perfusion pressure (CePP). This section discusses setting up the Camino device to measure ICP. Refer to the Camino Advanced Monitoring CAM01 Operating Manual for parameter specification and setup of the Camino monitor.

NOTE: The ICP alarm limits and alarm responses are configured at the V 12/V 21 when using a Camino device.

11.4.1 Assembling the Mounting Bracket for Camino Connection Cables

A special mounting bracket must be assembled before using the Camino device with the V 12/V 21.

1. Locate the Camino connection cable components (as shown in FIGURE 11-5).

NOTE: Two (2) screws are included.

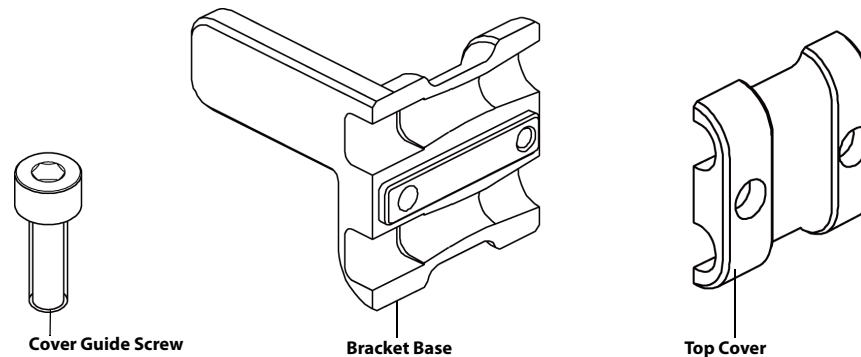

FIGURE 11-5 Camino Connection Cable Components

2. Insert the two cables into the bracket base (as shown in FIGURE 11-6).

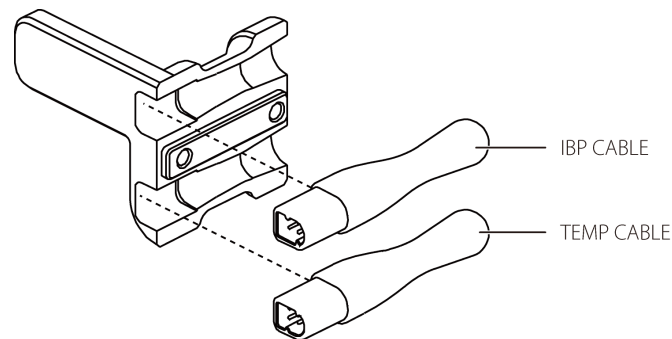

FIGURE 11-6 Camino Mounting Bracket Cable Insertion

3. Insert the two screws into the top cover and secure them (as shown in FIGURE 11-7). Once assembled, mounting bracket resembles FIGURE 11-8.

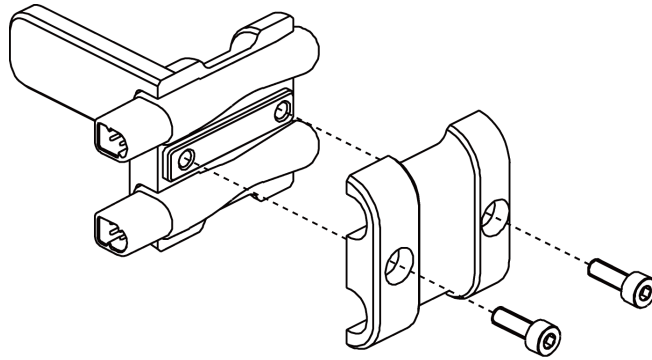

FIGURE 11-7 Camino Mounting Bracket Assembly

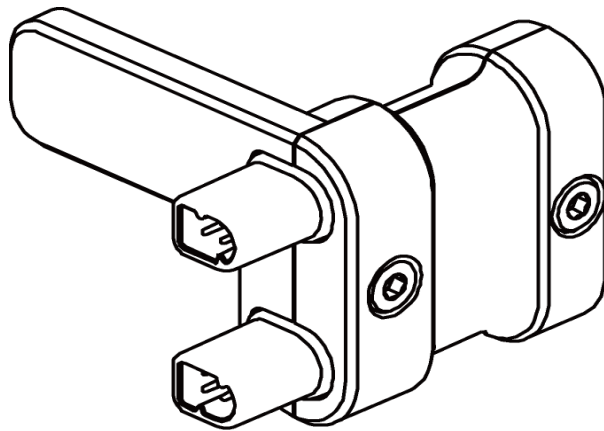

FIGURE 11-8 Camino Assembled Mounting Bracket

11.4.2 Connecting to the Camino Device

One bedside monitor cable, the mounting bracket (shown in FIGURE 11-8) and one adapter (as shown FIGURE 11-10) are needed to obtain an ICP measurement.

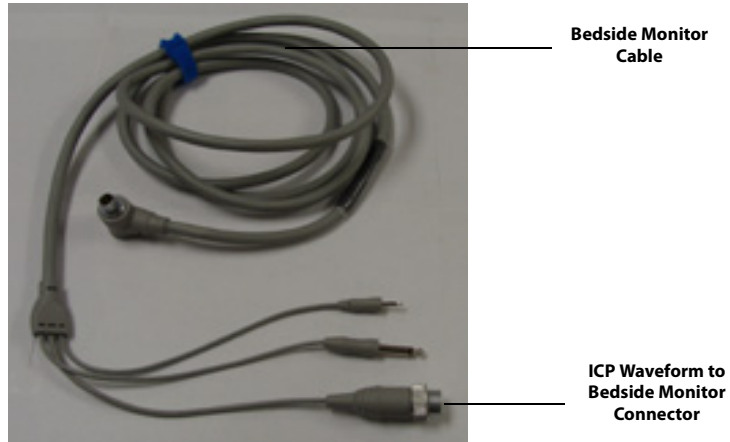

FIGURE 11-9 Cables Needed for ICP Measurement

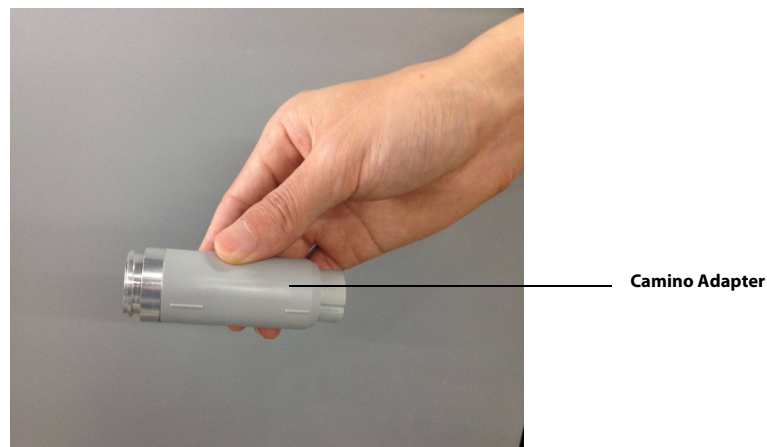

FIGURE 11-10 Camino Adapter

1. Connect the Camino connection ICP cable into the Camino adapter (shown in FIGURE 11-11).



FIGURE 11-11 Connecting the Transducer Cable and Camino Adapter

2. Connect the ICP waveform bedside monitor connector to the Camino adapter (shown in FIGURE 11-12). Connect the other end of the ICP waveform bedside monitor connector into the Camino device.



FIGURE 11-12 Connecting the Bedside Monitor Connector and Camino Adapter

3. Insert the Camino connection cable into the VPS IBP connector beside the Temp connector (shown in FIGURE 11-13).



FIGURE 11-13 IBP Cable Inserted into VPS

4. For Camino operating instructions, including starting the Camino device, zeroing pressure transducers, and calibrating the bedside monitor, refer to the Advanced Monitoring CAM01 Operating Manual.

11.5 IBP Tile Layouts

The IBP parameter is shown in a digital tile and a waveform tile format.

11.5.1 IBP Digital Tile Layout

The IBP digital tile displays:

1. Systolic values
2. Message area
3. Diastolic values
4. Unit of measure
5. Diastolic alarm limits
6. Mean alarm limits
7. Mean value
8. Systolic alarm limits

NOTE: When displaying a pulsatile pressure, the format will be SYS/DIA (MEAN) (as shown in FIGURE 11-14). When displaying a non-pulsatile pressure, the format will be MEAN (SYS/DIA) (as shown in FIGURE 11-15).

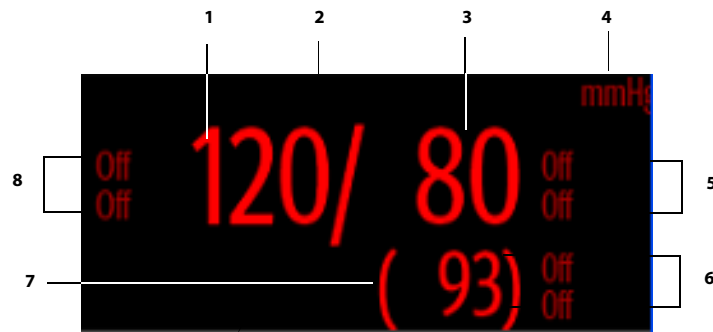

FIGURE 11-14 Example IBP Digital Tile (Pulsatile)

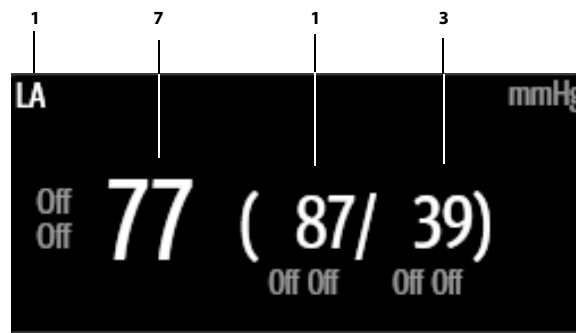
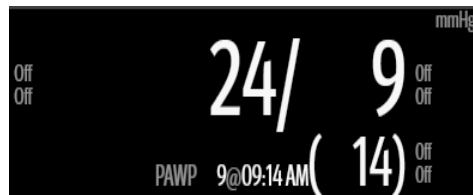

FIGURE 11-15 Example IBP Digital Tile (Non-Pulsatile)

11.5.2 PA Digital Tile



11.5.3 PAWP Digital

To use the current PA diastolic value as the PAWP value, the **Accept PAWP** button was selected in the PAWP dialog box, and the PAWP timeout was not exceeded.

NOTE: To display the PAWP value and timestamp in the digital tile, the **Accept PAD as PAWP** button must be configured to **On**. Refer to "Configuring the IBP Parameter" on page 11-3 for additional information.

11.5.4 Intracranial Pressure (ICP) Digital Tile

- When displaying ICP, the format is MEAN CePP

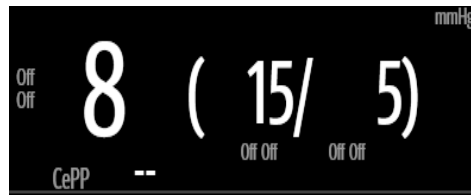

11.5.4.1 Cerebral Perfusion Pressure (CePP) Digital

The system calculates the CePP value by subtracting the Mean Arterial Pressure (MAP) from the Intra-Cranial Pressure (ICP).

NOTE: To display the CePP value in the digital tile, the **CePP** button must be configured to **On**. Refer to "Configuring the IBP Parameter" on page 11-3 for additional information.

11.5.5 Intraabdominal Pressure (IAP) Digital Tile

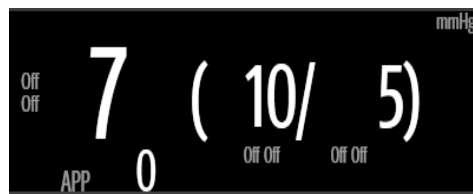

11.5.5.1 Abdominal Perfusion Pressure (APP) Digital

The system calculates the APP value by subtracting the Intra-Abdominal Pressure (IAP) from the Mean Arterial Pressure (MAP).

NOTE: To obtain the MAP digital, the other IBP tile must be configured as an **ART** line.

NOTE: To display the APP value in the digital tile, the **Display APP** button must be configured to **On**. Refer to "Configuring the IBP Parameter" on page 11-3 for additional information.

11.5.6 About the IBP Tile

- The IBP tile displays all blood pressure in units of **mmHg** with a resolution of 1 mmHg.
- During cuff inflation or deflation, the cuff pressure replaces the mean value.
- If the IBP measurement is invalid, “- -” displays in place of digits.
- An IBP tile displays “**XX**” in place of numerics when the transducer has not been zeroed.

11.5.7 Message Area

The message area provides information about the current state of the IBP parameter. If there is more than one message to display, the messages scroll.

MESSAGE*	DETAILS
IBPX Systolic High Alarm Violation (where <X> is the corresponding channel name)	Indicates that the current value is either equal to or higher than the set alarm limits.
IBPX Systolic Low Alarm Violation (where <X> is the corresponding channel name)	Indicates that the current value is either equal to or lower than the set alarm limits.
IBPX Diastolic High Alarm Violation (where <X> is the corresponding channel name)	Indicates that the current value is either equal to or higher than the set alarm limits.
IBPX Diastolic Low Alarm Violation (where <X> is the corresponding channel name)	Indicates that the current value is either equal to or lower than the set alarm limits.
IBPX Mean High Alarm Violation (where <X> is the corresponding channel name)	Indicates that the current value is either equal to or higher than the set alarm limits.
IBPX Mean Low Alarm Violation (where <X> is the corresponding channel name)	Indicates that the current value is either equal to or lower than the set alarm limits.
Zeroing Complete	Indicates that the zeroing request successfully completed.
Unable To Zero	Indicates that the zeroing request did not complete successfully.

11.5.8 IBP Waveform Tile Layout

The IBP waveform tile displays:

1. Tile name
2. IBP waveform
3. IBP waveform scale
4. Unit of measure
5. PA waveform

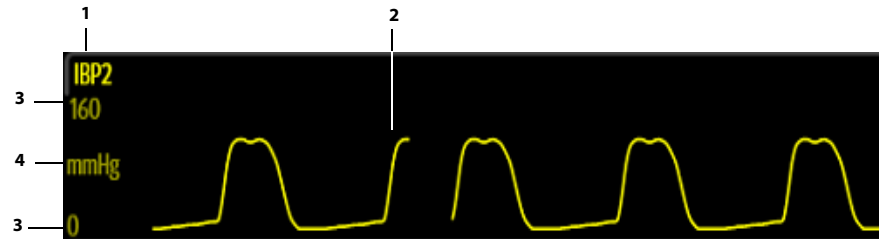

FIGURE 11-16 Example IBP2 Waveform Tile

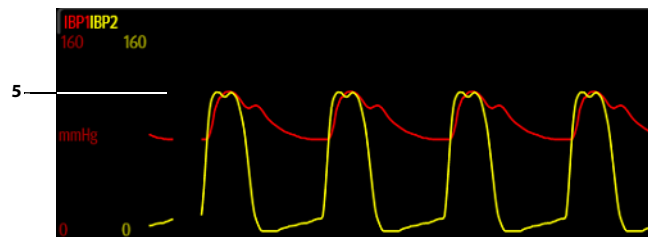

FIGURE 11-17 Example ARTPA Overlapping Waveform Tile

NOTE: Refer to "Overlapping Waveform" on page 3-14 for additional information.

11.6 Inserting the PA Catheter

NOTE: One of the IBP channels must be labeled PA to use the PA Insertion dialog.

1. Prepare the catheter for insertion into the patient.
2. Select the **Procedures** tab from the Navigation Area.
3. Select the **PA Insertion** button.
The PA Insertion dialog displays (as shown in FIGURE 11-19).

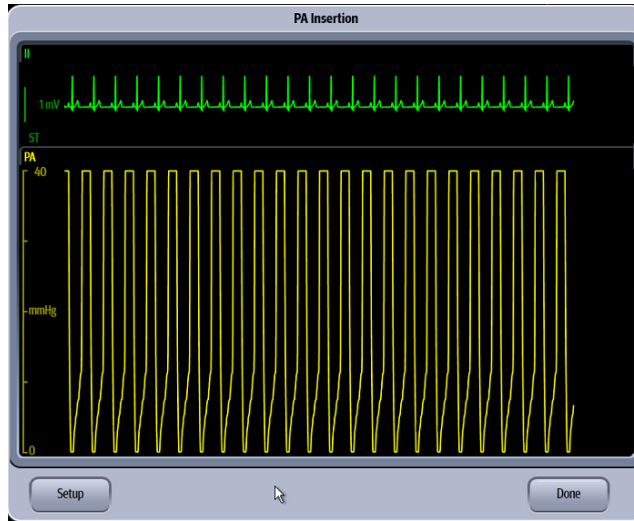

FIGURE 11-18 Example PA Insertion Dialog

4. Select the **Setup** button.
5. Select the buttons described in TABLE 11-4 to configure the tab.

TABLE 11-4

FUNCTION	DESCRIPTION	SETTINGS*
PA Scale	Configures the PA waveform height in the PA Insertion dialog.	-10 to 10 mmHg, 0 to 20 mmHg, 0 to 40 mmHg , 0 to 60 mmHg, 0 to 80 mmHg, 60 to 140 mmHg, 0 to 160 mmHg, 0 to 225 mmHg, 0 to 320 mmHg
PA Speed	Configures the PA waveform speed in the PA Insertion dialog.	6.25 mm/sec , 12.5 mm/sec, 25 mm/sec

* The factory default configuration settings are in bold.

6. Continue with catheter installation following hospital protocol.
7. Use the dialog to help insert the catheter into the patient. The PA Insertion dialog reflects waveform changes as the PA catheter progresses during the installation procedure.

NOTE: Use the PA Insertion dialog as an adjunct. It is not meant to replace proper clinical technique, fluoroscopy, and other methods used to verify proper insertion criteria.

11.7 Pulmonary Artery Wedge Pressure (PAWP)

Pulmonary Artery Wedge Pressure (PAWP) is a pressure measurement derived from a PA catheter when the PA distal balloon is inflated and the catheter advances and occludes a distal pulmonary artery. PAWP pressure is a reflection of the pressure in the left ventricle at end-diastole.

NOTE: One of the channels must be labeled PA to measure PAWP.

11.7.1 Measuring PAWP

NOTE: To ensure accurate wedge pressure readings, rezero the PA pressure channel and check the PA catheter for integrity, kinks and/or leaks prior to measurement.

1. Select the PA digital or waveform tile.
2. Select the **Zero** button.
3. Select the **PAWP** button.
The PAWP dialog displays (as shown in FIGURE 11-19).

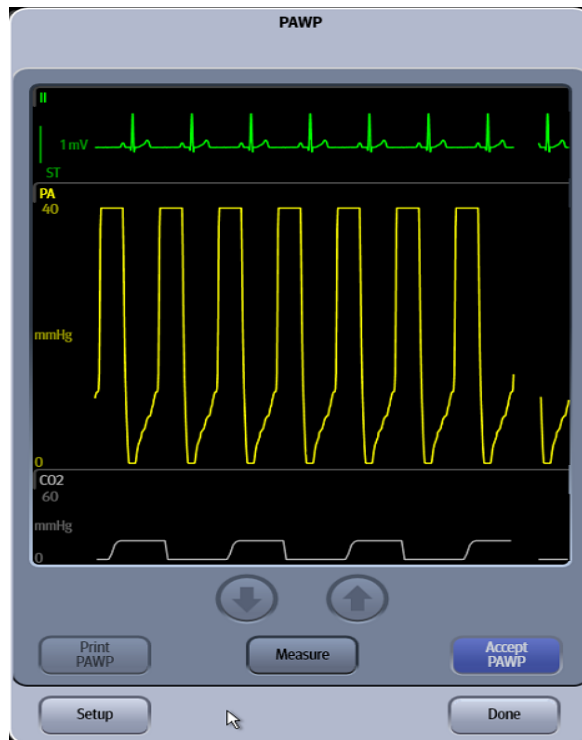



FIGURE 11-19 Example PAWP Dialog

4. Inflate balloon, then watch PA waveform for the wedge waveform.

NOTE: Follow manufacturer's suggested procedures and hospital policy for PAWP balloon inflation.

5. Once a satisfactory wedge waveform is detected, press the **Measure** button to freeze the waveforms within the PAWP dialog.

6. Adjust the reference line to the estimated wedge measurement by selecting the   arrow buttons.
7. Select the **Accept PAWP** button to save the PAWP measurement.
The PAWP value and associated timestamp display in the PA digital tile.
8. Optional - select **Measure** to further adjust the reference line.
9. Select the **Done** button.

11.7.2 Understanding the PAWP Dialog

- The PAWP dialog supports an expanded PA waveform and up to three (3) other waveforms (primary ECG lead, PA, and CO₂/Respiration).
- The waveforms in the PAWP dialog are ordered as follows: ECG lead, ART, PA, and Resp/CO₂.
- All waveforms in the PAWP dialog scroll at the configured PA sweep speed.
- All waveforms in the PAWP dialog share a common erase bar.
- The ECG waveform is always positioned in the first waveform position in the PAWP dialog.
- When the ART waveform is configured to On in the PAWP Setup dialog, and it is active, the ART waveform displays in the second waveform position in the PAWP dialog.
- PA is the third waveform in the PAWP dialog.
- Resp/CO₂ is the fourth waveform in the PAWP dialog.
- When currently monitoring CO₂, the CO₂ waveform is included in the PAWP dialog.
- In the absence of the CO₂ waveform, the Respiration waveform is included in the PAWP dialog.

11.7.3 PAWP Setup Dialog

1. Select the PA digital or waveform tile.
2. Select the **PAWP** button.
3. Select the **Setup** button.
The PAWP Setup dialog displays (as shown in FIGURE 11-20).

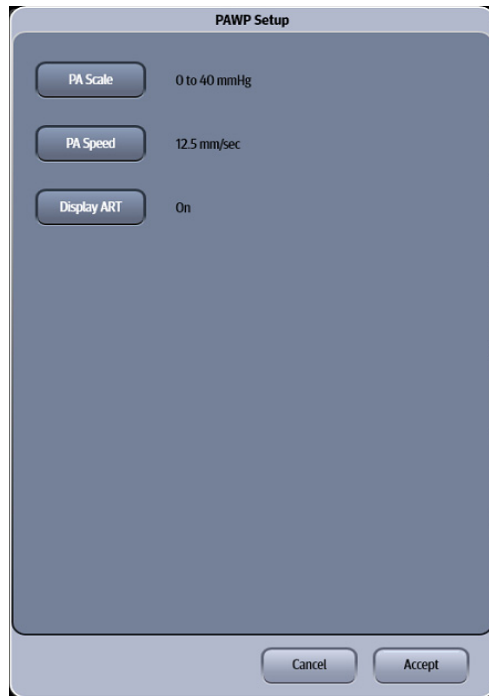

FIGURE 11-20 Example PAWP Setup Dialog

4. Select the buttons described in TABLE 11-5 to configure the tab.

TABLE 11-5

BUTTON	DESCRIPTION / COMMENTS	CHOICES*
PA Scale	Configures the waveform height and width.	-10 to 10 mmHg 0 to 20 mmHg 0 to 40 mmHg 0 to 60 mmHg 0 to 80 mmHg 60 to 140 mmHg 0 to 160 mmHg 0 to 225 mmHg 0 to 320 mmHg
PA Speed	Configures the waveform sweep speed.	6.25 mm/sec 12.5 mm/sec 25 mm/sec
Display ART	Configures whether or not to display the ART waveform in the PAWP dialog.	On , Off

* *The factory default configuration settings are in bold.*

5. Select the **Cancel** or **Accept** button.
- The **Cancel** button closes the dialog without saving the settings.
 - The **Accept** button saves the settings and closes the dialog.

11.8 IBP Troubleshooting

The IBP tile message area displays messages indicating the current state of the IBP parameter. If there is more than one message to display, the messages scroll.

MESSAGE/PROBLEM	REASON	SOLUTION
Damped invasive waveform	Air bubbles in tubing.	Eliminate air from tubing.
	Kinked catheter.	Change position of catheter, check patient.
	Catheter against wall of blood vessel.	Check for leaks at connector, flush catheter.
	Blood in tubing.	Pump pressure bag up to 300 mmHg.
	Catheter partially occluded with clot.	Consult physician.
IBP not displayed / no IBP waveform	Improper setup.	Check display setup in monitor setup.
	Cable not plugged in.	Check cable.
	Transducer not connected.	Check transducer connection.
	Stopcock turned improperly.	Check transducer.
	Transducer not zeroed.	Check and zero the transducer.
Dashes "--" display in place of numerics.	The measured result is invalid or out of range.	Change to a pulsatile label.
	IBP might be set to non-pulsatile labels like CVP, LA, RA, and ICP.	
Abnormally high or low readings	Transducer too HIGH or too LOW.	Check patient, adjust transducer, rezero.
Unable to Zero	Stopcock not open to atmosphere.	Check transducer.
PAWP button disabled	One IBP channel must be labeled PA.	Label an IBP channel as PA.

Heart Rate (HR)

Introduction	12-2
HR Dialog	12-2
Heart Rate Digital Tile Layout	12-4
HR Troubleshooting	12-6

12.1 Introduction

This chapter describes the heart rate (HR) parameter and the various HR sources available. The HR sources when configured for the Auto mode are ECG, pulsatile channels of IBP, and SpO₂. The **V 12/V 21** calculates the high and low HR values based on the HR source.

Patient Sizes

Intended patient types: Adult, Pediatric, Neonate.

VPS

The VPS module calculates the HR parameter value through an IBP channel, ECG, or SpO₂ parameters.

12.2 HR Dialog

The **HR** dialog (as shown in FIGURE 12-1) contains an **Alarm** tab and a **Setup** tab. A description of each tab follows.

12.2.1 Navigating to the HR Dialog

- Select the HR digital tile or waveform tile.
- OR
1. Select the **Setup** tab from the Navigation Area.
 2. Select the **Parameters** button.
 3. Select the **HR** button.
- The **HR** dialog displays (as shown in FIGURE 12-1).

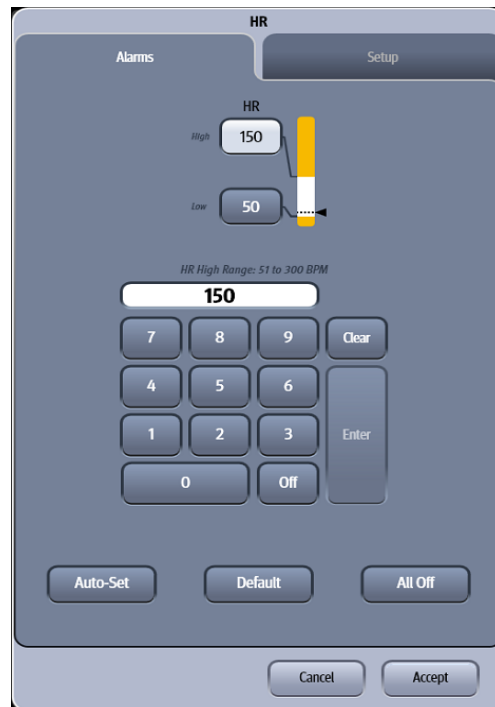

FIGURE 12-1 Example HR Dialog (Alarms Tab)

12.2.2 Configuring Heart Rate Alarm Limits

Refer to "Configuring Alarm Limits" on page 8-2 for additional information.

12.2.3 Configuring the Heart Rate Parameter

1. Select the HR digital tile.
2. Select the **Setup** tab (as shown in FIGURE 12-2).

NOTE: The current parameter setting displays in bold to the right of each button.

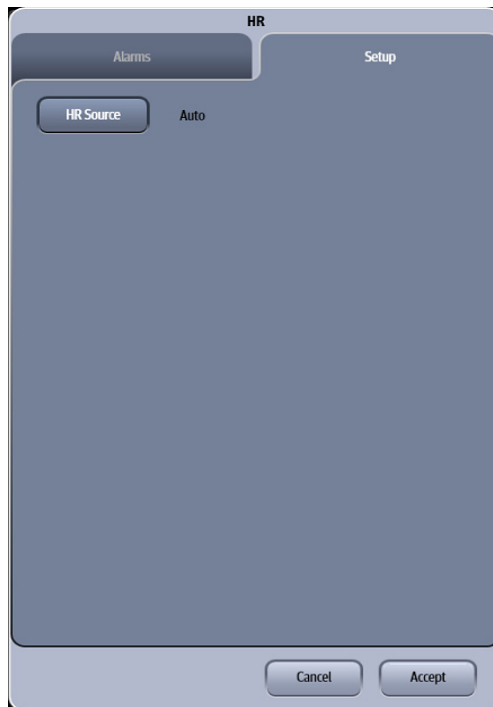

FIGURE 12-2 Example HR Dialog (Setup Tab)

3. Select the buttons described in TABLE 12-1 to configure the tab.

TABLE 12-1

BUTTON	DESCRIPTION / COMMENTS	CHOICES*
HR Source	Configures the HR source.	Auto , ECG, all available pulsatile IBP channels, SpO ₂
NOTE:		The monitor produces an audible systole beep from the current heart rate source. To adjust the systole beep volume or to disable it, refer to "Audio Levels Dialog" on page 2-13.

* The factory default configuration settings are in bold.

4. Select the **Cancel** or **Accept** button.
 - The **Cancel** button closes the dialog without saving the settings.
 - The **Accept** button saves the settings and closes the dialog.

12.3 Heart Rate Digital Tile Layout

The HR digital tile displays:

1. Tile name
2. Message area
3. Units of measure
4. HR value
5. HR Source
6. High and Low alarm limits
7. HR value (hollow font)

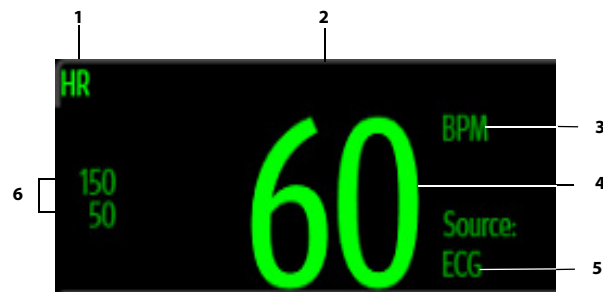

FIGURE 12-3 Example HR Digital Tile

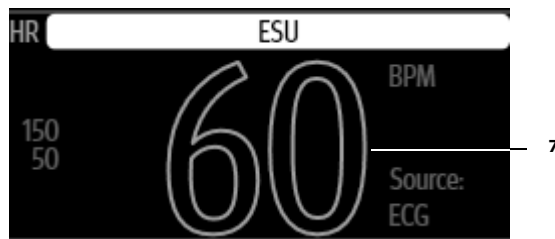

FIGURE 12-4 Example HR Digital Tile (during an ESU event)

12.3.1 About the HR Tile

- The HR tile displays heart rate in units of **BPM** with a resolution of 1 BPM.
- If the measurement is invalid, "--" displays in place of digits.
- The HR tile displays the value in a hollow font (as shown in FIGURE 12-4) during an ECG Noise, ESU event, or when the reliability of the measurement value is compromised.
- Non-alarming text displays:
 - In the ECG color when the HR source is invalid or the HR source is ECG.
 - In the IBP <channel> color when the HR source is an IBP <channel>.
 - In the SpO₂ color when the HR source is SpO₂.
 - In the NIBP color when the HR source is NIBP.

12.3.2 HR Alarms

Refer to "Factory Default Alarm Limits" on page 8-4 for additional information.

12.3.3 Message Area

The HR Tile Message Area displays messages indicating the current state of the HR parameter. When a message is displayed, it overwrites the units of measure. If there is more than one message to display, the messages scroll.

MESSAGE	DETAILS
HR High Alarm Violation	The HR alarm limit is equal to or exceeds the high HR alarm limit.
HR Low Alarm Violation	The HR alarm limit is equal to or exceeds the low HR alarm limit.
ESU	An ESU event was detected and the ECG Respiration is disabled.
ECG Noise	There is noise present on one or more leads.

12.4 HR Troubleshooting

The HR tile message area displays messages indicating the current state of the HR parameter. If there is more than one message to display, the messages scroll.

MESSAGE/PROBLEM	REASON	SOLUTION
The HR value display in a hollow font (as shown in FIGURE 4-4).	The measurement value is compromised by an ECG Noise or ESU event.	Resolve technical issue.
Dashes "--" display in place of numerics.	The measurement is invalid.	Check the patient.

Temperature (Temp)

Introduction	13-2
Temperature Dialog	13-3
Measuring ICT	13-5
Measuring Temperature	13-9
Temperature Digital Tile Layout.....	13-13
Temperature Troubleshooting	13-15

13.1 Introduction

This chapter describes the Temperature function in detail, including configuring alarm limits, configuring the temperature, and taking temperature measurements.

The **V 12/V 21** temperature measurement function is designed to take a continuous temperature reading from 400 series or compatible probes.

Temp units of °C and °F are available. Adjust the temperature units in the **Setup** tab.

The **V 12/V 21** has three (3) potential temperature measurement sources: the T1, T2, and T Blood. Data for up to two (2) of these sources may be simultaneously displayed.

Patient Sizes

Intended patient types: Adult, Pediatric, Neonate (with the exception of TBlood).

VPS

The VPS module supports one (1) Temperature connector (as shown in FIGURE 13-1). Refer to "Measuring Temperature" on page 13-9 for additional information.

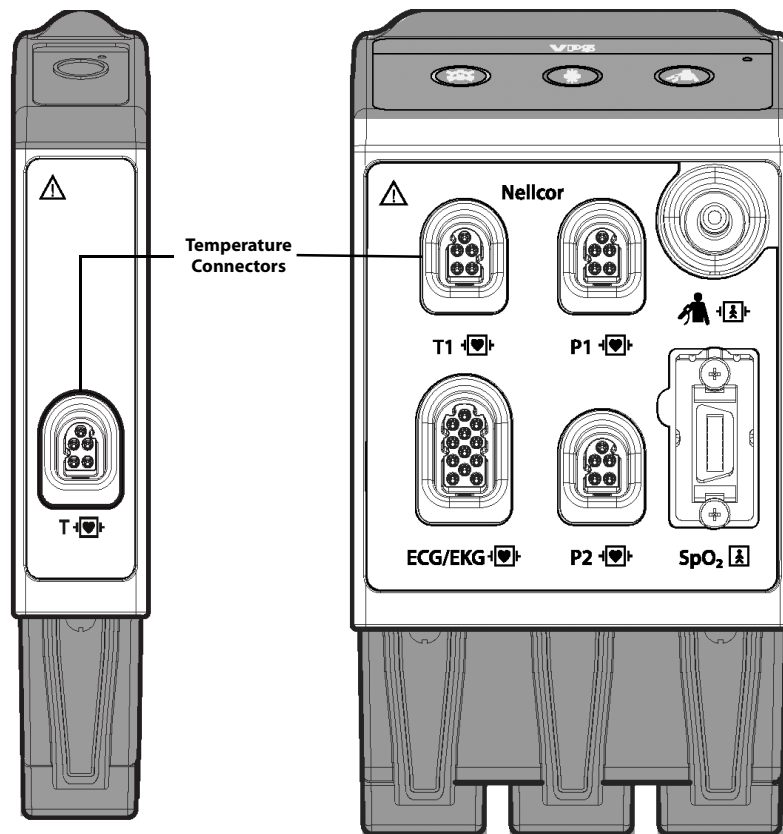

FIGURE 13-1 Example VPS Temp Connectors (Standalone Module on Left, VPS on Right)

Display Setup

To see the Temp values, Temp must be configured to display on the Main Screen. Refer to "Display Options Dialog" on page 3-2 for additional information.

13.2 Temperature Dialog

The **Temperature** dialog (as shown in FIGURE 13-2) contains an **Alarms** tab and a **Setup** tab. A description of each tab follows.

13.2.1 Navigating to the Temperature Dialog

- Select the Temp digital tile.

OR

1. Select the **Setup** tab from the Navigation Area.
2. Select the **Parameters** button.
3. Select the **Temperature** button.

The Temperature dialog displays (as shown in FIGURE 13-2).

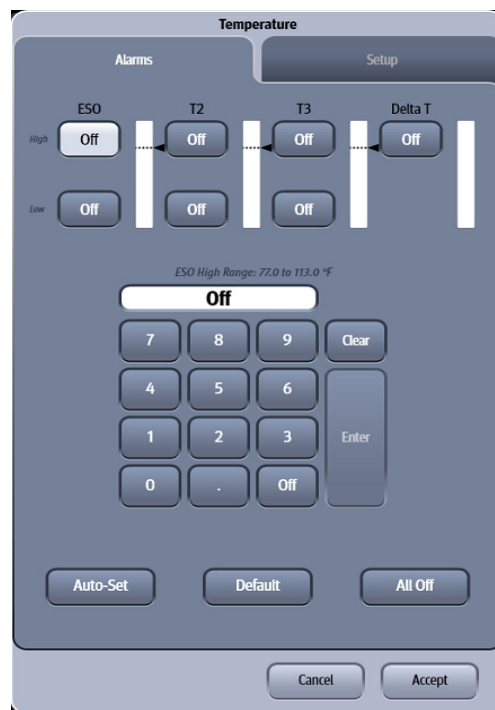

FIGURE 13-2 Example Temperature Dialog (Alarms Tab)

13.2.2 Configuring Temperature Alarm Limits

Refer to "Configuring Alarm Limits" on page 8-2 for additional information.

13.2.3 Configuring the Temperature Parameter

1. Select the Temp digital tile.
2. Select the **Setup** tab (as shown in FIGURE 13-3).

NOTE: The current parameter setting displays in bold to the right of the button.

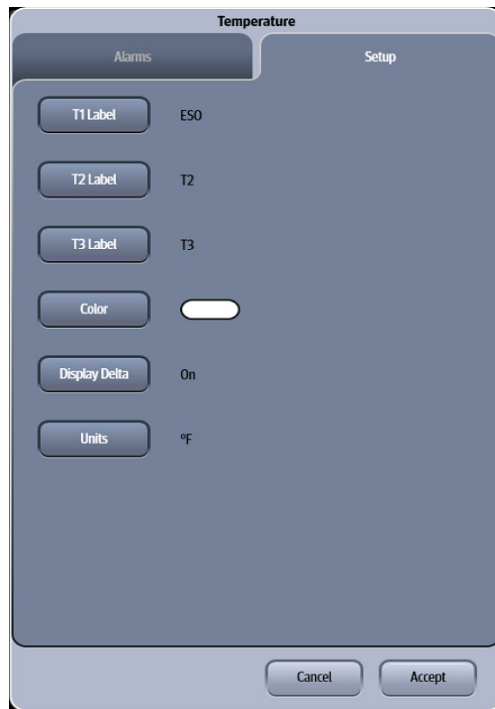

FIGURE 13-3 Example Temperature Dialog (Setup Tab)

3. Select the buttons described in TABLE 13-1 to configure the tab.

TABLE 13-1

BUTTON	DESCRIPTION / COMMENTS	CHOICES*
T<channel number>Label	Configures the temperature channel label.	T<channel number> 1, 2 or 3, ESO, NAS, REC, BLA, AXI, SKI, and ICT.
Color	Configures the temperature parameter and graphical plot color.	16 distinct colors Factory default color is white .
Display Delta	Configures whether delta temperature displays in the temperature tile.	On , Off
Units	Configures the temperature unit of measure.	°C °F

* *The factory default configuration settings are in bold.*

4. Select the **Cancel** or **Accept** button.
- The **Cancel** button closes the dialog without saving the settings.
 - The **Accept** button saves the settings and closes the dialog.

13.3 Measuring ICT

The VPS module can interface with the Camino Advanced Monitor CAM01 in Adult, Pediatric and Neonatal patients. The Camino measures intracranial pressure (ICP), intracranial temperature (ICT) and calculates cerebral perfusion pressure (CePP). This section discusses setting up the Camino device to measure ICT. Refer to the Camino Advanced Monitoring CAM01 Operating Manual for parameter specification and setup of the Camino monitor.

NOTE: The ICT alarm limits and alarm responses are configured at the V 12/V 21 when using a Camino device.

13.3.1 Assembling the Mounting Bracket for Camino Connection Cables

A special mounting bracket must be assembled before using the Camino device with the V 12/V 21.

1. Locate the Camino connection cable components (as shown in FIGURE 13-4).

NOTE: Two (2) screws are included.

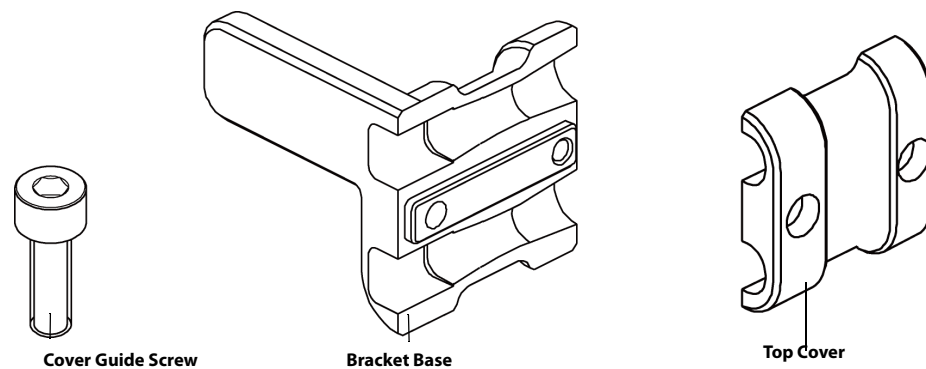

FIGURE 13-4 Camino Connection Cable Components

2. Insert the two cables into the bracket base (as shown in FIGURE 13-5).

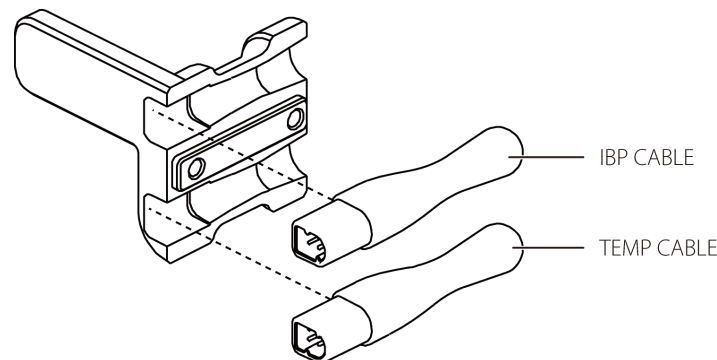

FIGURE 13-5 Camino Mounting Bracket Cable Insertion

3. Insert the two screws into the top cover and secure them (as shown in FIGURE 13-6). Once assembled, mounting bracket resembles FIGURE 13-7.

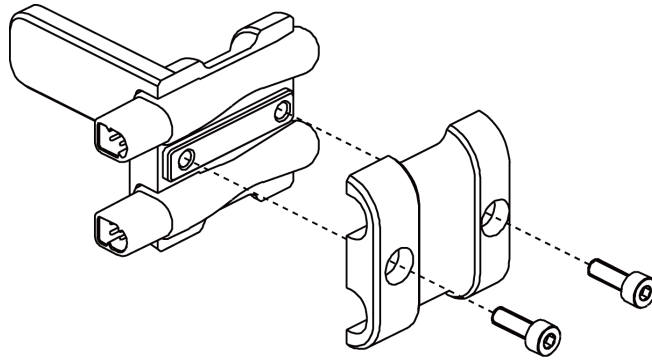

FIGURE 13-6 Camino Mounting Bracket Assembly

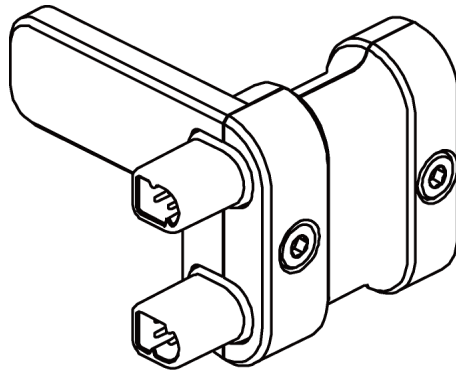

FIGURE 13-7 Camino Assembled Mounting Bracket

13.3.2 Connecting to the Camino Device

One bedside monitor cable, the mounting bracket (shown in FIGURE 13-7) and one adapter (as shown FIGURE 13-9) in are needed to obtain an ICT measurement.

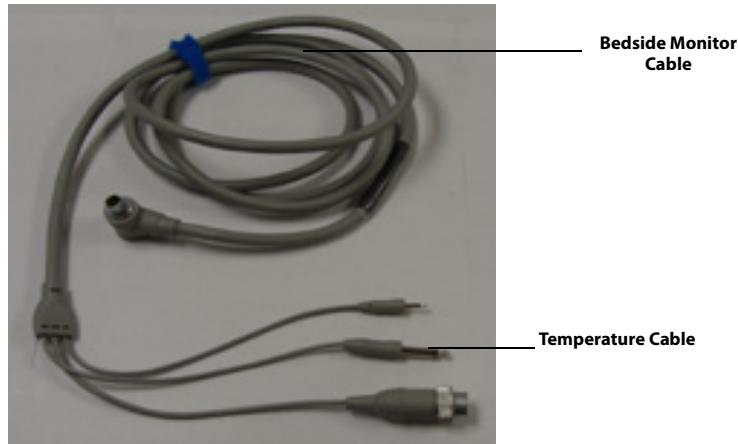

FIGURE 13-8 Cables Needed for ICT Measurement

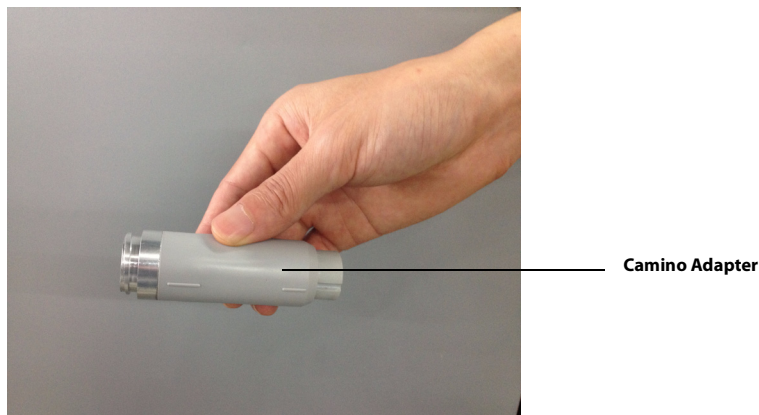

FIGURE 13-9 Camino Adapter

1. Connect the Camino temperature cable into the Camino cable bracket cable (shown in FIGURE 13-10).



FIGURE 13-10

2. Insert the Camino connection cable into the VPS IBP connector beside the Temp connector (as shown in FIGURE 13-11).



FIGURE 13-11 Temp Cable Installed into VPS

3. For Camino operating instructions, including starting the Camino device, zeroing pressure transducers, and calibrating the bedside monitor, refer to the Advanced Monitoring CAM01 Operating Manual.

13.4 Measuring Temperature

The different temperature probes are described in detail in the following sections.

13.4.1 Temperature Probes

13.4.1.1 Skin Temperature Sensor with 400 Series Thermistor

Description (P/N 0206-03-0112-02)

The Skin Temperature Sensor is designed for placement on the surface of the skin. The skin temperature sensor consists of a thermistor embedded in an adhesive backed foam disk. One side of the foam disk is covered by a metallic film. The opposite surface of the foam is coated with a medical grade hypo-allergenic adhesive suitable for skin application. The hypo-allergenic adhesive holds the sensor in place. The foam thermally insulates the sensor and the metallic layer reflects external infrared heat energy thus providing accurate measurement of body temperature.

The temperature transducer is in the form of an electrically insulated 400 series thermistor. The accuracy of the thermistor is $\pm 0.2^\circ$ Celsius in the range of 5° Celsius to 45° Celsius. The assembly is disposable, single use only, and packaged sterile.

This device is intended for use with electronic temperature monitors accepting 400 series thermistor sensors or equivalent that are equipped with alarms. To interconnect the probe with the instrument, use cable part number 040-000091-00.

Electrical leakage current of the device, when used with the monitor and cable, comply with IEC 601-1/EN60601-1.

Indications

The Skin Temperature Sensor is indicated for use in the routine monitoring of skin temperature.

Contraindications

The Skin Temperature Sensor may be contraindicated over traumatized areas.

Adverse Reactions

Adverse reactions reported during applications of Skin Temperature Sensors include skin abrasions and tissue burns due to aberrant electro-cautery current pathways.

Directions For Use And Precautions

1. Dry skin completely in the area intended for sensor placement.
2. Remove the protective backing and place the sensor onto the previously dried skin area.
3. Align the sensor's connector with the monitor cable's connector and push firmly to assure full contact. Forced mating of the connectors without proper alignment may cause damage to the connectors and interruption in electrical continuity.

WARNING: During procedures employing electro-cautery, use currently acceptable procedures to minimize conditions of the thermistor and lead wires functioning as an alternate path for radio-frequency current to return to ground, causing localized tissue burns. Procedures which may minimize risk of electro-surgical burns are: keep both active and ground electrodes of the electro-cautery system in close proximity so that the temperature sensor is outside the radio-frequency current field. Keep temperature monitor with its associated cables separated from electro-cautery systems. Unusual, fast artificial variations in temperature readings may occur with concomitant applications of the electro-cautery system.

WARNING: Temperature probes are sterile unless unit container is opened or damaged.

CAUTION: Temperature probes are for single use only. Destroy after single use. Do not re-sterilize.

13.4.2 Esophageal Stethoscope with 400 Series Thermistor Temperature Sensor

Description (P/Ns 0206-03-0112-02, 0206-03-0118-02)

The esophageal stethoscope with temperature sensor is a disposable device which provides for accurate measurement of core body temperature as well as transmission of heart and lung sounds. Heart and lung sounds are transmitted across a thin cuff wall, through the side and distal openings of the tube. Made of a special material which optimizes sound transmission and remains both durable and flexible, the cuff maintains its integrity and prevents secretion from entering the tube. For connection to any standard ear piece, a male luer adaptor is attached to the proximal end of the esophageal stethoscope. The stethoscope is 19 inches (48.3cm) long. The tube, the cuff and luer adaptor are made of lightweight, non-toxic, implant tested material.

The temperature transducer is in the form of an electrically insulated "400" series thermistor, which is permanently secured within the lumen of the esophageal stethoscope. The thermistor is placed at the distal end of the tube. The accuracy of the thermistor is $\pm 0.2^{\circ}\text{C}$ in the range of 5 - 45°C.

The assembly is disposable, single use only, and packaged sterile. It is available in sizes 12 and 18 French.

This device is intended for use with electronic temperature monitors accepting 400 series thermistor sensors or equivalent that are equipped with alarms. To interconnect the probe with the instrument, use cable part number 040-000091-00.

Electrical leakage current of the device (sensor and esophageal stethoscope) when used with monitor and cable, comply with IEC 601-1/EN 60601-1.

Indications

The esophageal stethoscope with temperature sensor is indicated where patient temperature monitoring is desired along with accurate heart and lung sound monitoring. The sensor is designed for insertion into the esophagus.

Contraindications

The use of the esophageal stethoscope may be contraindicated in neonates and small infants undergoing tracheostomy or internal jugular artery catheterization or laser surgical procedures.

Adverse Reactions

Adverse reactions reported during applications of esophageal stethoscopes with or without temperature sensors include accidental tracheal or bronchial intubation accompanied with airway obstruction, esophageal abrasion and or perforation, pharyngeal abrasion and tissue burns due to aberrant electro-cautery radio frequency current pathways.

Directions for Use and Precautions

1. If a patient has to be intubated with an endotracheal tube, perform the intubation prior to the placement of the esophageal stethoscope.
2. Lubricate the stethoscope prior to the insertion and place the stethoscope in accordance with currently acceptable medical procedures.
3. Verify position of the stethoscope by direct laryngoscopy or other acceptable medical techniques.
4. Align the sensor's connector with the monitor cable's connector and push firmly to assure full contact. Forced mating of the connectors without proper alignment may cause damage to the connectors and interruption in electrical continuity.

WARNING: During procedures employing electro-cautery, use currently acceptable procedures to minimize conditions of the thermistor and lead wires functioning as an alternate path for radio-frequency current to return to ground, causing localized tissue burns. Procedures which may minimize risk of electro-surgical burns are: keep both active and ground electrodes of the electro-cautery system in close proximity so that the temperature sensor is outside the radio-frequency current field. Keep temperature monitor with its associated cables separated from electro-cautery systems. Unusual, fast artificial variations in temperature readings may occur with concomitant applications of the electro-cautery system.

WARNING: Temperature probes are sterile unless unit container is opened or damaged.

CAUTION: Temperature probes are for single use only. Destroy after single use. Do not re-sterilize.

13.4.3 Esophageal/Rectal Temperature Probe with 400 Series Thermistor

Description (P/Ns 0206-03-0209-02, 0206-03-0212-02)

Hypothermia and hyperthermia are well recognized clinical conditions necessitating temperature monitoring. The economical and disposable Esophageal/Rectal Temperature Probe is a sensitive and accurate temperature transducer, to be used clinically where continuous temperature monitoring is required.

The temperature sensor is in the form of an electrically insulated "400" series thermistor, which is permanently secured within a PVC tube. The bullet tipped PVC tube provides for atraumatic insertion. The thermistor is placed at the distal end of the tube. The accuracy of the thermistor is $\pm 0.2^{\circ}\text{C}$ in the range of 5 - 45°C.

The assembly is disposable, single use only, and packaged sterile. It is available in sizes 9 and 12 French.

This device is intended for use with electronic temperature monitors accepting 400 series thermistor sensors or equivalent that are equipped with alarms. To interconnect the probe with the instrument, use cable part number 040-000091-00.

Electrical leakage current of the device (sensor and PVC tube) when used with monitor and cable, comply with IEC 601-1/EN 60601-1.

Indications

The Esophageal/Rectal Temperature Probe is indicated where continuous patient temperature monitoring is desired. The sensor is designed for insertion into the esophagus, nasopharynx, or rectum.

Contraindications

The use of the esophageal/rectal sensor may be contraindicated in neonates and small infants undergoing tracheostomy or internal jugular artery catheterization and laser surgical procedures.

Adverse Reactions

Adverse reactions reported during applications of these sensors include accidental tracheal or bronchial intubation accompanied with airway obstruction, esophageal or rectal abrasion and/or perforation, pharyngeal abrasions and tissue burns due to aberrant electro-cautery radio-frequency current pathways.

Directions For Use And Precautions

1. If a patient has to be intubated with an endotracheal tube, perform the intubation prior to placing the temperature probe into esophagus.
2. Lubricate the temperature probe prior to insertion and place the probe in accordance with currently acceptable medical procedures.
3. Verify position of the probe by acceptable medical procedures.
4. Align the sensor's connector with the monitor cable's connector and push firmly to assure full contact. Forced mating of the connectors without proper alignment may cause damage to the connectors and interruption in electrical continuity.

WARNING: During procedures employing electro-cautery, use currently acceptable procedures to minimize conditions of the thermistor and lead wires functioning as an alternate path for radio-frequency current to return to ground, causing localized tissue burns. Procedures which may minimize risk of electro-surgical burns are: keep both active and ground electrodes of the electro-cautery system in close proximity so that the temperature sensor is outside the radio-frequency current field. Keep temperature monitor with its associated cables separated from electro-cautery systems. Unusual, fast artificial variations in temperature readings may occur with concomitant applications of the electro-cautery system.

WARNING: Temperature probes are sterile unless unit container is opened or damaged.

CAUTION: Temperature probes are for single use only. Destroy after single use. Do not re-sterilize.

13.5 Temperature Digital Tile Layout

The Temperature tile displays:

1. Temperature name
2. Tile label
3. Up to two (2) temperature values
4. Message area
5. Unit of measure
6. High and low alarm limits
7. Delta value

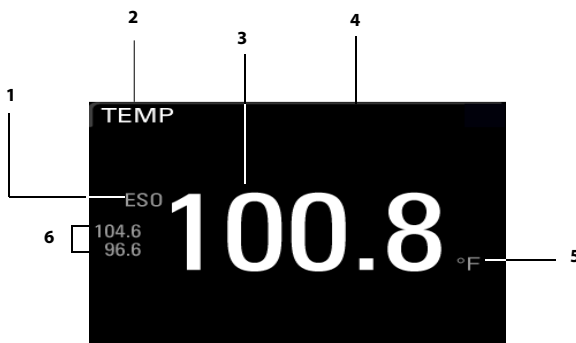

FIGURE 13-12 Example Digital Temp Tile with a single temperature

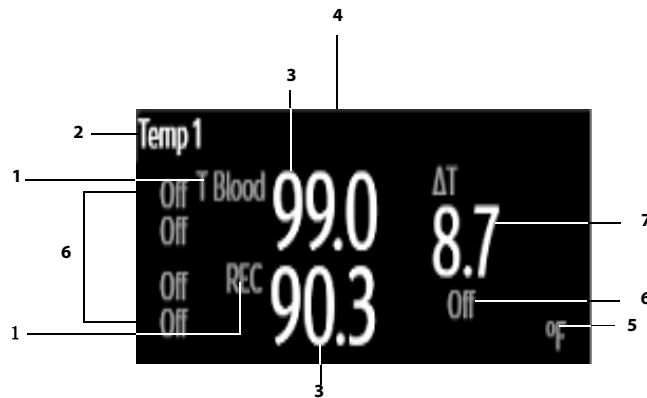

FIGURE 13-13 Example Digital Temp Tile with two temperatures and delta

NOTE: **Delta Temperature displays if it is enabled and if at least two temperatures are being monitored. Refer to "Configuring the Temperature Parameter" on page 13-3 for additional information.**

13.5.1 About the Temperature Tile

- The Temp tile displays temperature in the configured units of measure, with a resolution of 0.1°C when the unit of measure is Celsius and 0.1°F when the unit of measure is Fahrenheit.
- If the Temp measurement is invalid, "--" displays in place of digits.
- The temperature tile can support two formats; one for a single temperature display and one for dual temperature display.
- The temperature tile automatically reconfigures between the single temperature format and the dual temperature format as needed when the probes are inserted and removed.

13.5.2 Temperature Alarms

Refer to the **Temp Tab on page 8-6** for additional information.

13.5.3 Message Area

The message area provides information about the current state of the CO₂ parameter. If there is more than one message to display, the messages scroll.

MESSAGE*	DETAILS
<Temperature Label> High Alarm Violation	Indicates that the current value is either equal to or higher than the set alarm limits.
<Temperature Label> Low Alarm Violation	Indicates that the current value is either equal to or lower than the set alarm limits.
Delta T High Alarm Violation	Indicates that the current value is either equal to or higher than the set alarm limits.

13.6 Temperature Troubleshooting

The Temp tile message area displays messages indicating the current state of the Temp parameter. If there is more than one message to display, the messages scroll.

MESSAGE/PROBLEM	REASON	SOLUTION
Dashes "--" display in place of numerics.	The measurement is invalid.	Check the patient.
Temperature probes not working	Poor probe contact with body.	Check the body surface contact at the probe tip. Reposition or apply thermoconductive gel.
Temperature not displayed in tile	Improper display setup.	Check Display Setup and change as needed.
	Cable not plugged in.	Check the cable.

This page intentionally left blank.

Non-Invasive Blood Pressure (NIBP)

Introduction	14-2
NIBP Dialog	14-3
Measuring NIBP	14-5
General NIBP Information	14-8
NIBP Tile Layouts	14-9
NIBP Troubleshooting	14-12

14.1 Introduction

This chapter describes the Non-Invasive Blood Pressure (NIBP) function in detail including how to configure NIBP alarm limits, monitor NIBP, and configure the NIBP parameter.

The **V 12/V 21** calculates NIBP values using the oscillometric method of noninvasive blood pressure measurement. The NIBP measurement includes Systolic (Sys), Diastolic (Dia) and Mean Blood Pressure. These measurements are determined accurate after comparison to auscultatory measurements per ANSI/AAMI SP10 standard with the fifth Korotkoff sound which is used to determine diastolic pressure.

The **V 12/V 21** measures blood pressures that are equivalent to those obtained by a trained observer using the cuff/stethoscope auscultation method, within the limits prescribed by the American National Standard, Electronic or automated sphygmomanometers.

Patient Sizes

Intended patient types: Adult, Pediatric, Neonate.

VPS Connector

The VPS module supports one (1) NIBP connector (as shown in FIGURE 14-1). Refer to "Measuring NIBP" on page 14-5 for additional information.

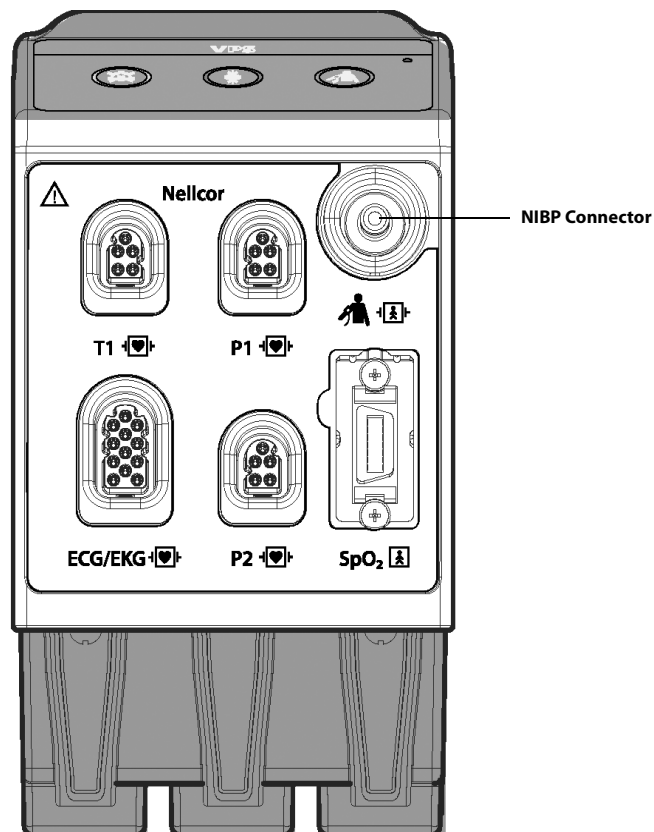

FIGURE 14-1 Example Nellcor VPS NIBP Connector

Display Setup

To see the NIBP values, NIBP must be configured to display on the Main Screen. Refer to "Display Options Dialog" on page 3-2 for additional information.

14.2 NIBP Dialog

The NIBP dialog (as shown in FIGURE 14-2) contains an **Alarms** tab and a **Setup** tab. A description of each tab follows.

14.2.1 Navigating to the NIBP Dialog

- Select the NIBP digital tile.

OR

1. Select the **Setup** tab from the Navigation Area.
2. Select the **Parameters** button.
3. Select the **NIBP** button.

The **NIBP** dialog displays (as shown in FIGURE 14-2).

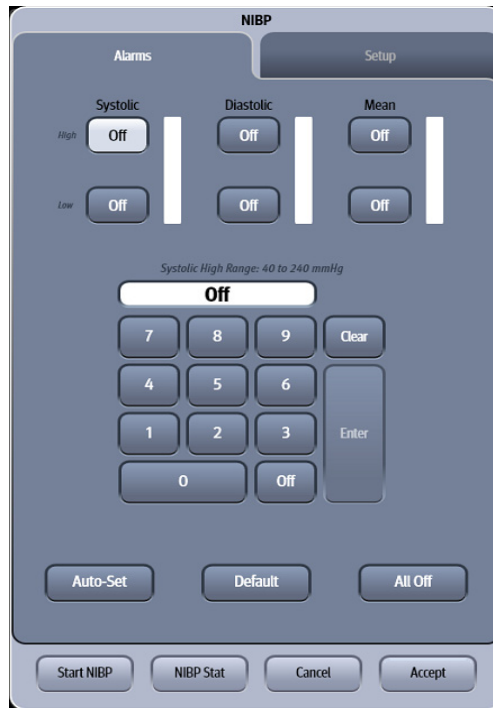

FIGURE 14-2 Example NIBP Dialog (Alarms Tab)

14.2.2 Configuring NIBP Alarm Limits

Refer to "Configuring Alarm Limits" on page 8-2 for additional information.

14.2.3 Configuring the NIBP Parameter

1. Select the NIBP digital tile.
2. Select the **Setup** tab (as shown in FIGURE 14-3).

NOTE: The current parameter setting displays in bold to the right of each button.

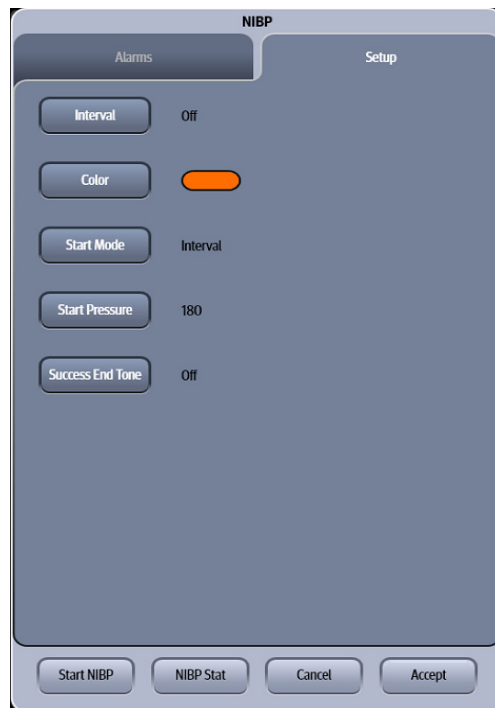

FIGURE 14-3 Example NIBP Dialog (Setup Tab)

3. Select the buttons described in TABLE 14-1 to configure the tab.

TABLE 14-1

BUTTON	DESCRIPTION / COMMENTS	CHOICES*
Interval	Configures the time separation between NIBP automatic measurements.	Off , 1 min, 2 min, 3 min, 5 min, 10 min, 15 min, 20 min, 30 min, 1 hr, 2 hrs, 4 hrs
Color	Configures the NIBP parameter color.	There are 16 different colors available. The factory default is orange .
Start Mode	Configures the NIBP measurement mode. Refer to "Measurement Types" on page 14-5 for additional information.	Interval , Clock
Start Pressure	Configures the start pressure value for the NIBP measurement.	Adult: 100 to 280 (180) Pediatric: 60 to 180 (140) Neonate: 40 to 120 (100)
Success End Tone	Configures the monitor to sound a distinct audio tone when it obtains a successful blood pressure measurement.	On, Off

* The factory default configuration settings are in bold.

4. Select the **Cancel** or **Accept** button.
- The **Cancel** button closes the dialog without saving the settings.
 - The **Accept** button saves the settings and closes the dialog.

14.3 Measuring NIBP

CAUTION: To monitor and trend NIBP measurements, the NIBP tile or NIBP list tile must be configured to display. No NIBP monitoring occurs unless one of these tiles are configured to display.

NOTE: Try to measure infants when they are calm. A kicking or crying baby may disturb or jiggle the cuff, causing noise within the system and resulting in unstable blood pressure readings. If necessary, hold the cuffed limb steady, without impeding circulation. Do not hold onto the cuff and do not pat the cuffed limb to comfort the child.

NOTE: NIBP cannot be taken under all conditions. Even manual methods, employing a sphygmomanometer and stethoscope, will not work on unstable or active patients.

14.3.1 Measurement Types

MEASUREMENT TYPE	DESCRIPTION
Interval	Takes NIBP measurements based on a specified time period (for example, every 10 minutes, 20 minutes, etc.).
Clock	Synchronizes the NIBP measurement interval with the real time clock. For example, if you start the BP measurement at 1:05 pm, the next measurement will be taken at 2:05 pm.
NIBP Stat	Allows continuous measurements for a maximum of five (5) minutes or 10 measurements. In the Stat mode, measurements are taken every two (2) seconds).
Manual	Allows for an instant NIBP measurement without configuring an interval or clock setting.

14.3.2 NIBP Cuff Checklist

- On infants, try the calf. Irritable newborns will react to the cuff pressure but may tolerate the calf better than the arm. Place the cuff just above the ankle.
- On infants, place the cuff lightly. If the cuff is too snug, it will not work properly. On infants, you should be able to easily move the cuff over the limb.
- To reduce errors, adjust the cuff so that little or no air is present within the cuff.
- Ensure that the cuff lies directly against the patient's skin. No clothing should come between the patient and the cuff.
- Do not place the NIBP cuff on a limb that is being utilized for any other medical procedure. For example, an IV catheter or an SpO₂ sensor.
- Verify the cuff's Index line falls between the Range lines.
- Ensure that the cuff is properly applied to avoid pressure on the limb not falling to zero between measurements when the cuff is wrapped too tightly.
- For skin that is fragile (i.e., on pediatrics, geriatrics, etc.), consider using a longer interval between measurements to decrease the number of cuff inflations over a period of time. In extreme cases, a thin layer of soft roll or cotton padding may be applied to the limb in order to cushion the skin when the cuff is inflated. This measure may affect NIBP performance and should be used with caution.

14.3.3 Measuring NIBP

NOTE: Try using disposable cuffs on infants. Disposable cuffs are more pliant than reusable ones. They generally fit smaller infants better.

NOTE: Select the cuff size based on the limb circumference of the patient. The design dimensions of the cuffs and their intended uses are based on recommendations of the American Heart Association.

NOTE: Replace cuffs that have become brittle as they age.

NOTE: Ensure that the pressure tubes are not compressed or restricted.

1. Select an appropriate sized cuff for the patient.
2. Attach the cuff hose to the NIBP connector on the VPS (as shown in FIGURE 14-1)
3. Apply the cuff to the patient.
4. If not already selected, choose the patient size through the Patient Info dialogs.
5. If needed, change the starting cuff pressure through the **NIBP Setup** tab.

NOTE: Refer to **TABLE 14-1 on page 14-4 for additional information.**

6. Choose a measurement type.

NOTE: Refer to "Measurement Types" on page 14-5 for additional information.

NOTE: Inflate the cuff only after proper application to the patient's limb. Cuff damage can result if the cuff is left unwrapped and then inflated.

- The cuff inflates to the selected start pressure, slowly deflates, and collects the data for display. The cuff pressure displays in place of the Mean digital.
- If the inflation was inadequate, the NIBP retries a measurement for a maximum of three (3) times.
- The patient should remain still. After the pressure drops below the diastolic pressure, the measurements are displayed.
- If the Success End Tone is set to **On**, a tone indicates a successful measurement.

14.3.4 NIBP Interval Measurements

The NIBP Interval mode allows automatic measurements based on a specified time period (for example, every 10 minutes, 20 minutes).

1. Follow steps 1- 5 in the "Measuring NIBP" on page 14-6.
2. Select the **Interval** button from the **Setup** tab.
3. Select an interval period.
4. Select the **Start NIBP** button to begin the measurement.

NOTE: Once selected, the **Start NIBP** button changes to **Stop NIBP**.

NOTE: If an NIBP interval is changed when in the Interval mode, the change takes effect at the completion of the current interval measurement.

14.3.5 Pausing/Restarting a Clock or Interval NIBP Measurement

To suspend or postpone a scheduled measurement or a cycle already in progress:

- Select the **Stop NIBP** button in the **NIBP** dialog.
- Select the **Stop NIBP** button on the **Quick Functions** tab.
- Select the **Start/Stop NIBP** button on the VPS.

NOTE: Once selected, the **Start NIBP** button changes to **Stop NIBP**.

NOTE: When an interval measurement is stopped, the NIBP status changes to **Idle**.

Restarting a Clock or Interval NIBP Measurement Once Paused

Once selecting **Stop NIBP**, the measurement pauses but the interval or clock configuration remains intact until the paused mode is exited. To exit the Paused mode, select the **Start NIBP** button. The interval or clock measurements resume.

14.3.6 NIBP Stat Measurements

The NIBP Stat mode allows continuous measurements for a maximum of five (5) minutes or 10 measurements. The number of measurements taken is dependent on the cuff pressure. In the Stat mode, measurements are taken every two (2) seconds.

- Start an NIBP Stat measurement by doing one of the following:
 - Select the **NIBP Stat** button in the **Quick Functions** tab.
 - Select the **NIBP Stat** button in the **NIBP** dialog.

NOTE: If the Stat mode is active, “**Intrv: STAT**” displays in the NIBP tile.

14.3.7 Stopping a Stat NIBP Measurement

To stop a Stat NIBP measurement cycle before the designated measurement period expires:

- Select the **Stop NIBP** button in the **NIBP** dialog.
- Select the **Stop NIBP** button on the **Quick Functions** tab.
- Select the **Start/Stop NIBP** button on the VPS.

NOTE: When the Stat cycle ends, the system returns to its previous measurement state.

14.4 General NIBP Information

14.4.1 Cuff Inflation Time

If the NIBP does not pressurize the cuff to the target pressure within 60 seconds, the cuff vents to atmosphere, and the NIBP Message Area alternately displays a retry message.

14.4.2 NIBP Pressure Limit Fail Safe

If the cuff is over-pressurized, the cuff automatically vents to the atmosphere, and the NIBP message window alternately displays **Cuff Over Pressure** and **Unable to Measure**. The maximum inflation pressures are:

- Adult: 330 mmHg
- Pediatric: 220 mmHg
- Neonate: 165 mmHg

14.5 NIBP Tile Layouts

The NIBP parameter is shown in a digital tile and a list tile format.

14.5.1 NIBP Digital Tile Layout

The NIBP digital tile displays:

1. Tile name
2. Message area
3. Systolic value
4. Diastolic value
5. Units of measure
6. Diastolic alarm limits
7. Mean alarm limits
8. Mean value/cuff pressure
9. Elapsed time since last measurement
10. Measurement interval
11. Systolic alarm limits

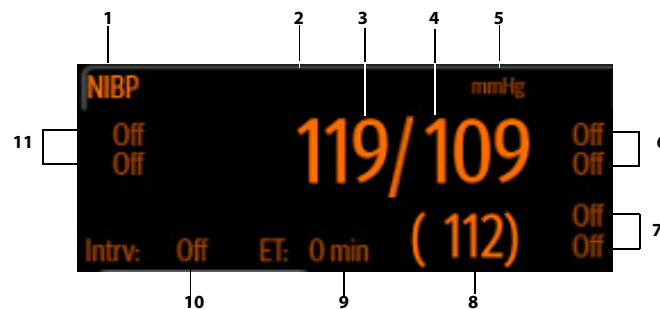

FIGURE 14-4 Example NIBP Digital Tile

14.5.2 About the NIBP Tile

- The NIBP tile displays all blood pressure in units of **mmHg** with a resolution of 1 mmHg.
- During cuff inflation or deflation, the cuff pressure replaces the mean value.
- If the NIBP measurement is invalid, "--" displays in place of digits.
- If the elapsed time of the current measurement meets or exceeds the configured timeout value, "--" displays in place of the BP values.

14.5.3 NIBP Alarms

Refer to the "Pressure Tab" on page 8-5 for additional information.

14.5.4 Heart Rate (HR) Measurement

If the HR Source is set to Auto, and no other source for HR is available, the NIBP measures the patient's heart rate for Neonate, Pediatric, and Adult sizes using a blood pressure cuff. If the system is unable to measure heart rate, "--" displays in place of a numeric.

NOTE: Refer to the Heart Rate (HR) chapter for additional information.

14.5.5 Message Area

The message area provides information about the current state of the NIBP parameter. When a message is displayed, it overwrites the units of measure. If there is more than one message to display, the messages scroll.

MESSAGE	DETAILS
NIBP Systolic High Alarm Violation	Indicates that the current value is either equal to or higher than the set alarm limits.
NIBP Systolic Low Alarm Violation	Indicates that the current value is either equal to or lower than the set alarm limits.
NIBP Diastolic High Alarm Violation	Indicates that the current value is either equal to or higher than the set alarm limits.
NIBP Diastolic Low Alarm Violation	Indicates that the current value is either equal to or lower than the set alarm limits.
NIBP Mean High Alarm Violation	Indicates that the current value is either equal to or higher than the set alarm limits.
NIBP Mean Low Alarm Violation	Indicates that the current value is either equal to or lower than the set alarm limits.
Measuring	The NIBP measurement is in process once the cuff begins to inflate.
Deflate	The measurement stopped and the cuff deflates.
Retry – Pump Higher	The measurement failed due to a reason other than inadequate cuff inflation pressure or hardware overpressure, and a retry is being attempted.
Cuff Inflation Pressure Failure; Retry	The measurement failed because of inadequate cuff inflation pressure and a retry is being attempted.
Unable to Measure	The system was unsuccessful in capturing the NIBP measurement. This message times out with the NIBP data and is based on the NIBP timeout.
Measurement Stopped	The measurement ceased before it finished taking the measurement.
Ready to Begin a Measurement	The monitor is ready to take an NIBP measurement.
Cuff Overpressure	The hardware overpressure limit was exceeded.
Check Calibration	Software detected that the overpressure transducer is out of calibration.
Press Start NIBP to Clear Overpressure	The NIBP cuff pressure exceeded the maximum pressure allowed for a given patient size.
Measurement Failed; Retry	The NIBP measurement was unsuccessful and must be retried.

14.5.6 NIBP List Tile Layout

The NIBP list tile displays the four (4) most recent measurements, with the most recent measurement at the top of the list. The NIBP list tile displays:

1. Tile name
2. Message area
3. Measurement time
4. Systolic value
5. Diastolic value
6. Unit of measure
7. Mean value
8. Interval

NOTE: When the background color of an NIBP value is highlighted (as shown in FIGURE 14-5), this indicates that the value violated an alarm threshold causing an alarm. The color corresponds to the alarm priority.

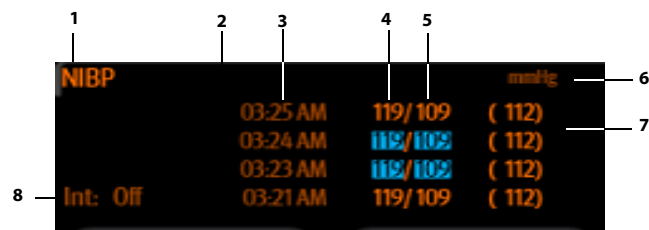

FIGURE 14-5 Example NIBP List Tile

14.6 NIBP Troubleshooting

The NIBP tile message area displays messages indicating the current state of the NIBP parameter. If there is more than one message to display, the messages scroll.

MESSAGE/PROBLEM	REASON	SOLUTION
Dashes "--" display in place of numerics.	Measurement is invalid.	Check sensor placement, move as necessary. Switch limb/notify physician.
Double beep tone heard	An NIBP Start button is selected when an NIBP measurement is currently in progress.	Complete the current measurement before selecting the NIBP Start button.
	The NIBP cuff is still deflating when the NIBP Start button is selected.	Wait for the cuff to deflate before selecting the NIBP Start button.
Unable to obtain a BP	Patient movement	Wait until patient is calm or gently hold limb.
	Cuff or hose NOT attached / leaking	Check all connections.
	HR irregular / arrhythmia present	Check patient and notify physician.
	Blood pressure is out of range.	Check patient and verify BP with manual method.
Reading too high or too low	Improper cuff size / brand	Measure patient limb. Use only properly sized approved accessories.
	Incorrect cuff size	Measure patient limb, use correct cuff.
The Start NIBP and NIBP Stat are disabled in the NIBP dialog.	Patient movement	Wait until patient is calm or gently hold limb.
	NIBP or NIBP list tile not configured to display.	Refer to "Configuring Display Presets" on page 3-3 for instructions on modifying the preset.
	There is an NIBP measurement in progress.	Wait until the measurement is complete.
	The NIBP cuff is deflating.	Wait until the cuff deflates before attempting to begin another measurement.

Pulse Oximetry (SpO₂)

Introduction	15-2
SpO2 Dialog	15-3
Measuring SpO2.....	15-7
SpO2 Tile Layouts	15-9
Performance Considerations	15-13
SpO2 Troubleshooting	15-14

15.1 Introduction

This chapter describes the SpO₂ function in detail including monitoring an SpO₂ measurement, configuring alarm limits, waveform color, and waveform speed.

Pulse oximetry is a continuous and non-invasive measurement of the amount of oxygen attached to the hemoglobin in red blood cells. SpO₂ is an estimation of arterial oxygen saturation. The **V 12/V 21** comes standard with Nellcor® SpO₂ or Masimo SpO₂ which measures the SpO₂ high and low limits.

Patient Sizes

Intended patient types: Adult, Pediatric, Neonate.

VPS Connector

The VPS module supports one (1) SpO₂ connector. Refer to "Taking an SpO₂ Measurement" on page 15-7 for additional information.

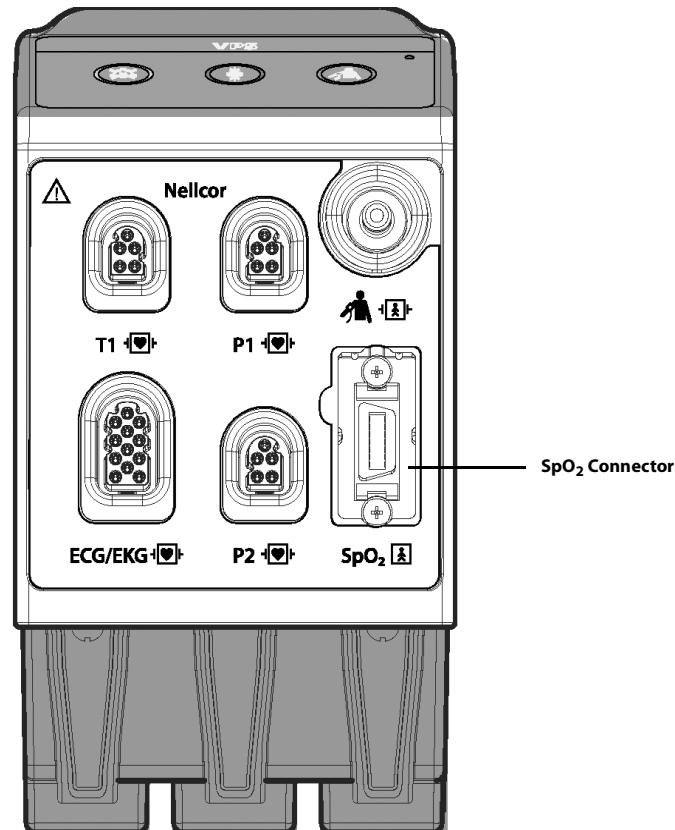

FIGURE 15-1 Example Nellcor VPS SpO₂ Connector

Display Setup

To see the SpO₂ values, SpO₂ must be configured to display on the Main Screen. Refer to "Display Options Dialog" on page 3-2 for additional information.

15.2 SpO₂ Dialog

The **SpO₂** dialog (as shown in FIGURE 15-2) contains an **Alarms** tab, **Setup** tab, and a **Waveform** tab. A description of each tab follows.

15.2.1 Navigating to the SpO₂ Dialog

- Select the SpO₂ digital or waveform tile.

OR

1. Select the **Setup** tab from the Navigation Area.
2. Select the **Parameters** button.
3. Select the **SpO₂** button.

The **SpO₂** dialog displays (as shown in FIGURE 15-2).

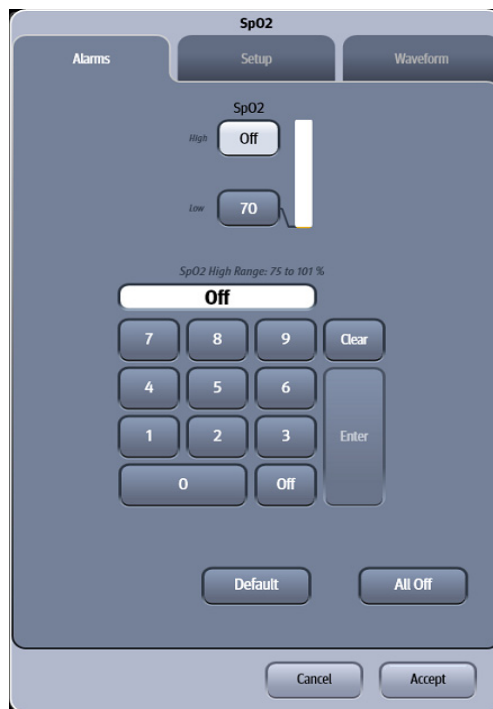

FIGURE 15-2 Example SpO₂ Dialog (Alarms tab)

15.2.2 Configuring SpO₂ Alarm Limits

Refer to "Configuring Alarm Limits" on page 8-2 for additional information.

15.2.3 Configuring the SpO₂ Parameter Setup

1. Select the SpO₂ digital or waveform tile.
2. Select the **Setup** tab (as shown in FIGURE 15-3).

NOTE: The current parameter setting displays in bold to the right of the each button.



FIGURE 15-3 Example Masimo SpO₂ Dialog (Setup Tab)

3. Select the buttons described in TABLE 15-1 to configure the tab.

TABLE 15-1

FUNCTION	DESCRIPTION	SETTINGS*
Color (Nellcor and Masimo)	Configures the SpO ₂ parameter and waveform color.	16 distinct colors Default color is cyan .
Sat-Seconds (Nellcor only)	Calculates the duration of the event multiplied by the number of percentage points that SpO ₂ falls outside of the saturation alarm threshold. This technology also features a safety precaution. When three (3) SPO ₂ alarm violations occur within 60 seconds, a priority 2 alarm will trigger even if the Sat-Seconds limit has not been reached.	Off , 10 sec, 25 sec, 50 sec, and 100 sec.
Avg. Mode (Nellcor only)	Configures how quickly the reported SpO ₂ value responds to changes in the patient's saturation.	Normal , Fast
Display PI (perfusion index) (Masimo only)	Configures whether there will be a perfusion rate displayed in the digital tile. The perfusion index allows clinicians to assess the pulse strength at the monitoring site for optimal sensor placement.	On , Off

* *The factory default configuration settings are in bold.*

TABLE 15-1 (Continued)

FUNCTION	DESCRIPTION	SETTINGS*
Sensitivity Mode (Masimo only)	Choose the sensitivity mode depending upon signal quality and patient motion. High This mode should be used for the sickest patients, where obtaining a reading is most difficult. Maximum Sensitivity is designed to interpret and display data for even the weakest of signals. This mode is recommended during procedures and when clinician and patient contact is continuous. Normal This mode provides the best combination of sensitivity and probe off detection performance. This mode is recommended for the majority of patients. APOD (Adaptive Probe Off Detection) This mode is the least sensitive in picking up a reading on patients with low perfusion but has the best detection for probe-off conditions. This mode is useful for patients that are at particular risk of the sensor becoming detached (pediatric, combative, etc.)	High, Normal, APOD
Post Avg. Time (Masimo only)	Configures the alarm delay.	2-4 sec, 4-6 sec, 8 sec , 10 sec, 12 sec, 14 sec, 16 sec
Fast Sat (Masimo only)	Configures whether there will be a turned on or off. FastSat enables rapid tracking of arterial oxygen saturation changes.	On , Off

* *The factory default configuration settings are in bold.*

4. Select the **Cancel** or **Accept** button.
 - The **Cancel** button closes the dialog without saving the settings.
 - The **Accept** button saves the settings and closes the dialog.

15.2.4 Configuring the SpO₂ Waveform

1. Select the SpO₂ digital or waveform tile.
2. Select the **Waveform** tab (as shown in FIGURE 15-4).

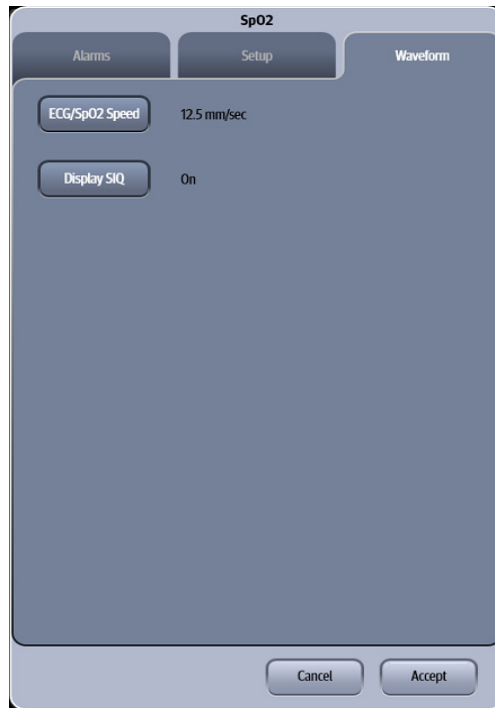

FIGURE 15-4 Example Nellcor SpO₂ Dialog (Waveform Tab)

3. Select the buttons described in TABLE 15-2 to configure the tab.

TABLE 15-2

FUNCTION	DESCRIPTION	SETTINGS*
ECG/SpO2 Speed	Configures the SpO ₂ pleth waveform and ECG waveform speed.	6.25 mm/sec, 12.5 mm/sec, 25 mm/sec , 50 mm/sec
Display SIQ (Masimo only)	Configures whether the SIQ displays in the SpO ₂ waveform tile. SIQ measures the signal quality.	On , Off

* *The factory default configuration settings are in bold.*

4. Select the **Cancel** or **Accept** button.
 - The **Cancel** button closes the dialog without saving the settings.
 - The **Accept** button saves the settings and closes the dialog.

15.3 Measuring SpO₂

15.3.1 Taking an SpO₂ Measurement

1. Select the appropriate sensor for the patient.
2. Attach the SpO₂ sensor to the patient's finger or other appropriate site.
3. Attach the SpO₂ patient cable to the sensor and plug the other end of the patient cable into the SpO₂ connector (as shown in FIGURE 15-1 on page 15-2).
4. The SpO₂ measurement displays when the **V 12/V 21** detects that the sensor is connected to the patient. A pleth waveform displays to the left of the SpO₂ digital tile, provided the SpO₂ parameter is part of the Display Setup.

CAUTION: Tissue damage or inaccurate measurements may be caused by incorrect SpO₂ sensor application or use, such as wrapping too tightly, applying supplemental tape, failing to inspect the sensor site periodically, or failing to position appropriately. Carefully read the sensor directions for use, the V 12/V 21 Operating Instructions, and all precautionary information before use.

CAUTION: Inaccurate SpO₂ measurements may be caused by:

- Incorrect sensor application or use
- Significant levels of dysfunctional hemoglobins, (e.g., carboxyhemoglobin or methemoglobin)
- Intra-vascular dyes such as indocyanine green or methylene blue
- Exposure to excessive illumination such as surgical lamps (especially ones with a xenon light source), bilirubin lamps, fluorescent lights, infrared heating lamps, or excessive ambient light. In such cases, cover the sensor site with opaque material
- Venous pulsations
- Electro-surgical interference
- Placement of a sensor on an extremity that has a blood pressure cuff, arterial catheter, or intra-vascular line
- Nail polish or fungus

CAUTION: Prolonged and continuous monitoring may increase the risk of skin erosion and pressure necrosis at the site of the sensor. Check the SpO₂ sensor site frequently to ensure proper positioning, alignment and skin integrity at least every eight (8) hours; with the Adult and Pediatric reusable finger sensor, check every four (4) hours; for neonates and patients of poor perfusion or with skin sensitive to light, check every 2 - 3 hours; more frequent examinations may be required for different patients. Change the sensor site if signs of circulatory compromise occur.

CAUTION: Many patients suffer from poor peripheral perfusion due to hypothermia, hypovolemia, severe vasoconstriction, reduced cardiac output, etc. These symptoms may cause a loss in vital sign readings.

CAUTION: When cleaning SpO₂ sensors, do not use excessive amounts of liquid. Wipe the sensor surface with a soft cloth, dampened with cleaning solution. Do not attempt to sterilize.

15.3.2 Nellcor[®] SpO₂

CAUTION: When equipped with Nellcor[®] SpO₂, use only Nellcor oxygen transducers including Nellcor Oxisensor[®] and OxiMax[®] patient dedicated adhesive sensors. Use of other oxygen transducers may cause improper oximeter performance.

Nellcor Sensors

Nellcor provides a family of sensors suitable for a wide variety of clinical settings and patients. Specific sensors have been developed for neonates, infants, children, and adults. Durasensor[®] and/ OxiMax[®] oxygen transducers are sterile adhesive sensors with optical components mounted on adhesive tape. Oxiband[®] oxygen transducers and the Duraform[®] oxygen transducer system are reusable sensors that are applied with disposable adhesive. The Durasensor DS-100A Adult Digit Oxygen Transducer is a reusable sensor with its optical components mounted in a plastic casing. The Nellcor RS-10 and Max-Fast[®] oxygen transducers are adhesive sensors for application on the forehead or temples.

Packaging of sterile sensors ensure sterile conditions until opened or damaged or until expiration date is reached.

NOTE: Consideration should be given to the disposal of packaging waste.

To order all Nellcor accessories and sensors call 1-888-744-1414.

Selecting a Nellcor Sensor

Sensors are designed for specific sites on patients with designated weight ranges. To select the appropriate sensor, consider the patient's weight, level of activity, adequacy of perfusion, which sensor sites are available, whether sterility is required, and the anticipated duration of monitoring.

15.3.3 Masimo SpO₂

V 12/V 21 monitors equipped with Masimo SET SpO₂ allow the user to adjust sensitivity and SpO₂ avg time. Choose the sensitivity mode depending upon signal quality and patient motion. In most cases, the normal setting is appropriate. If patient motion is limited, use the high sensitivity mode. Choose the average time based on the a number of seconds.

NOTE: Refer to TABLE 15-1 on page 15-4.

CAUTION: When equipped with Masimo SET[®] SpO₂, use only Masimo SET Oxygen Transducers including Masimo SET LNOP[®] and LNCS[®] Patient Dedicated Adhesive Sensors and Masimo SET PC Series Patient Cables. Use of other oxygen transducers may cause improper oximeter performance.

Masimo SET Sensors

Masimo SET provides a family of sensors suitable for a wide variety of clinical settings and patients. Specific sensors have been developed for neonates, infants, children, and adults. All sensors are indicated for continuous non-invasive monitoring of arterial oxygen saturation (SpO₂) and pulse rate, all sensors are non-sterile and usable during patient movement.

The Adult Reusable Finger Sensors can also be used for spot check applications if needed. All sensors are intended for single-patient use only unless indicated as "reusable."

15.4 SpO₂ Tile Layouts

The SpO₂ parameter is shown in a digital tile and a waveform tile format.

15.4.1 SpO₂ Digital Tile Layout

The SpO₂ digital tile displays:

1. Message area
2. Pulse rate (PR) label
3. PR value
4. PR unit of measure
5. Nellcor Sat-Seconds icon (pie-chart)
6. SpO₂ unit of measure
7. SpO₂ value
8. High and low alarm limits
9. Masimo perfusion index value (as shown in FIGURE 15-6)

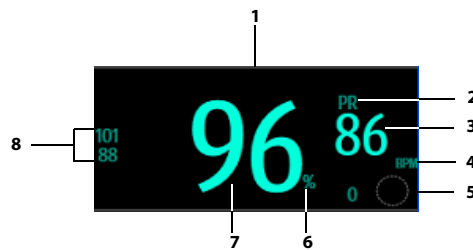

FIGURE 15-5 Example Nellcor SpO₂ Digital Tile

About the Nellcor Sat-Seconds Icon

Sat-seconds is used to control oximetry nuisance alarms.

The display rules of Sat-Seconds icon (as shown in FIGURE 15-5):

- Displays when the Sat-Seconds setting is activated.
- Indicates the current Sat-Seconds value beside the icon.
- Indicates the current status of the alarm graphically within the pie-chart icon.
- Fills in a clockwise direction when the monitor detects the SpO₂ value is outside the set alarm limits.
- Empties in a counter-clockwise direction when the SpO₂ reading falls within the set alarm limits.

About the Masimo Perfusion Index Indicator



FIGURE 15-6 Example Masimo SpO₂ Digital Tile

- Displays when the PI setting is activated
- Indicates the current PI value beside the PI label
- Displays invalid data as "--"
- Displays the PI resolution as 0.01% - 9.99% when $0 < PI < 10\%$.
- Displays the PI resolution as 10.0% - 20.0% when $20\% \geq PI \geq 10\%$.

15.4.2 About the SpO₂ Tile

- The SpO₂ tile displays in units of % with a resolution of 1%.
- If the SpO₂ measurement or PR is invalid, "--" displays in place of digits.
- If the elapsed time of the current measurement meets or exceeds the configured timeout value, "--" displays in place of the SpO₂ values.
- The SpO₂ PR value display in units of BPM with a resolution of 1 BPM.

15.4.3 SpO₂ Alarms

Refer to the "Gases Tab" on page 8-8 for additional information.

15.4.4 Message Area

The message area provides information about the current state of the SpO₂ parameter. If there is more than one message to display, the messages scroll.

MESSAGE	DETAILS
SpO ₂ High Alarm Violation	Indicates that the current value is either equal to or higher than the set alarm limits.
SpO ₂ Low Alarm Violation	Indicates that the current value is either equal to or lower than the set alarm limits.
No Sensor	Indicates that the SpO ₂ sensor or SpO ₂ cable was removed or there is no SpO ₂ sensor present at power up.
Board Failure	Indicates that the SpO ₂ board malfunctioned.
Interference	Indicates that noise is detected on the pulse signal preventing pulse separation from the noise.
Pulse Search	Indicates that the hardware settings are being adjusted in order to separate a pulse waveform.
Sensor Failure	Indicates that the sensor failed.
Sensor Off	Indicates that the sensor is off the patient.
Communication Error	Indicates that the VPS module is having problems communicating with the SpO ₂ board.

Nellcor Only Messages

MESSAGE	DETAILS
No Pulse	The Nellcor status indicates no detectable pulse is measured and all other measurement conditions are normal.
Check Sensor	Indicates that a faulty sensor was detected.
Sat-Seconds	The Nellcor status indicates that a Sat-Seconds alarm is active. Sat-Seconds limit controls the time that the % SpO ₂ level may fall below the alarm limit before an audible alarm sounds.
Motion alarm message	The Nellcor status indicates that a motion is detected.

Masimo Only Messages

MESSAGE	DETAILS
Unrecognized Sensor	Indicates that the Masimo board does not recognize the sensor.
Too Much Light	Indicates that there is too much ambient light to take a measurement.
Low Perfusion	Indicates that the patient's perfusion is low.
Defective Sensor	Indicates that a faulty sensor was detected.

15.4.5 SpO₂ Waveform Tile Layout

The SpO₂ waveform tile displays:

1. Tile name
2. Pleth waveform
3. Signal Index Quality (SIQ)

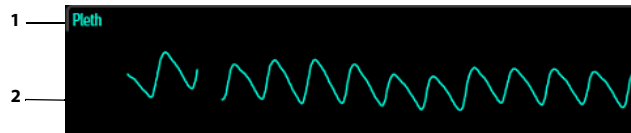

FIGURE 15-7 Example Nellcor SpO₂ Waveform Tile

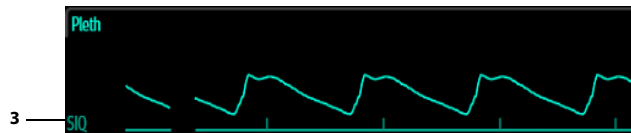

FIGURE 15-8 Example Masimo SpO₂ Waveform Tile (SIQ enabled)

15.4.6 About the SpO₂ Waveform Tile

- Displays in the configured SpO₂ color.
- Provides scrolling, real-time waveform data.
- Scrolls the waveform in the configured sweep speed.
- Automatically scales the SpO₂ waveform data area to maximize the vertical height of the Pleth waveform for the data range.
- If using Masimo SpO₂, the Signal Quality Index (SIQ) may display below the waveform if enabled.

NOTE: Refer to **TABLE 15-2** on page 15-6 for additional information.

15.5 Performance Considerations

To ensure optimal performance, use an appropriate sensor, apply it as directed and observe all warnings and cautions.

If excessive ambient light is present, cover the sensor site with opaque material. Failure to do so may result in inaccurate measurements. Light sources that can affect performance include surgical lights, especially those with a xenon light source, bilirubin lamps, fluorescent lights, infrared heating lamps, and direct sunlight.

When unable to get a reading, or the reading is inaccurate, consider the following:

- If your patient is poorly perfused, try applying the sensor to another site - such as a different finger or toe.
- Check that the sensor is properly aligned.
- In electrosurgery, make sure sensor is not too close to ESU devices or cables.
- Check to make sure the site area is clean/non-greasy. Clean site and sensor if needed.

CAUTION: A functional tester cannot be used to assess the accuracy of the pulse oximeter probe or a pulse oximeter monitor.

NOTE: If the supply mains is interrupted during SpO₂ monitoring, the V 12 switches power to battery backup if at least one battery is installed and charged. If power has been completely interrupted, SpO₂ monitoring continues when the supply mains is restored or a fully charged battery is installed, and power has been recycled to the monitor.

15.6 SpO₂ Troubleshooting

The SpO₂ tile message area displays messages indicating the current state of the SpO₂ parameter. If there is more than one message to display, the messages scroll.

MESSAGE/PROBLEM	REASON	SOLUTION
Dashes "--" display in place of numerics.	Measurement is invalid.	Check sensor placement, move as necessary. Switch limb/notify physician.
Do not see SpO ₂ parameter tiles in display.	Parameter not configured to display.	Refer to "Display Options Dialog" on page 3-2 for additional information.
Unable to obtain SpO ₂ reading	Patient has poor perfusion.	Switch limbs/notify physician.
	Sensor not on patient.	Reapply sensor.
	Cables loose / not connected.	Check connections, switch cable.
	Ambient light.	Switch limbs and cover sensor with opaque material.
No SpO ₂ waveform	Waveform not selected to display.	Refer to "Display Options Dialog" on page 3-2 for additional information.
	Cable or sensor not plugged in.	Check cable and sensor.
Low amplitude SpO ₂ signal	SpO ₂ sensor on same limb as cuff.	Check sensor placement, move as necessary.
	Patient has poor perfusion.	Switch limb/notify physician.

16.0

ST

Introduction	16-2
ST Dialog	16-2
ST Tile Layouts.....	16-9
ST Troubleshooting	16-13

16.1 Introduction

This chapter describes the ST parameter in detail including how to configure ST alarm limits, enable/disable ST analysis, adjust the ST ISO, J points, and review the ST waveforms for each active ECG lead. Monitoring ST is optional and needs to be enabled for analysis to begin.

The **V 12/V 21** calculates ST values and calls an alarm can be set for either single lead alarm or dual lead alarm. The ST single lead alarm initiates when one ST lead exceeds the defined alarm parameters. The ST dual lead alarm initiates when two ST leads exceeds the defined alarm parameters.

Patient Sizes

Intended patient types: Adult and Pediatric.

VPS

The VPS module supports the ST parameter through the ECG parameter.

Display Setup

To see the ST values, ST must be configured to display on the Main Screen. Refer to "Display Options Dialog" on page 3-2 for additional information.

16.2 ST Dialog

The **ST** dialog (as shown in FIGURE 16-1) contains an **Alarm** tab, **Setup** tab, **Adjust** tab, and a **Review** tab. A description of each tab follows.

16.2.1 Navigating to the ST Dialog

- Select the ST tile.

OR

1. Select the **Setup** tab from the Navigation Area.
2. Select the **Parameters** button.
3. Select the **ST** button.
The **ST** dialog displays (as shown in FIGURE 16-1).

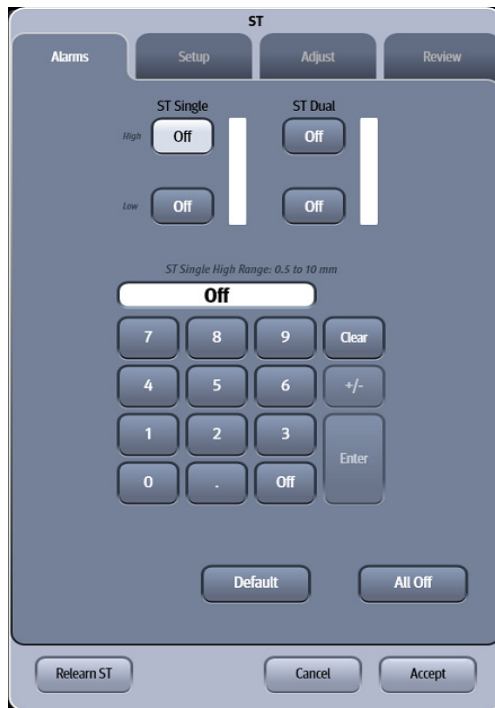

FIGURE 16-1 Example ST Dialog (Alarms Tab)

16.2.2 Configuring ST Alarms Limits

Refer to "Configuring Alarm Limits" on page 8-2 for additional information.

16.2.3 Configuring the ST Parameter

1. Select the ST tile.
2. Select the **Setup** tab (as shown in FIGURE 16-2).

NOTE: The current parameter setting displays in bold to the right of the each button.

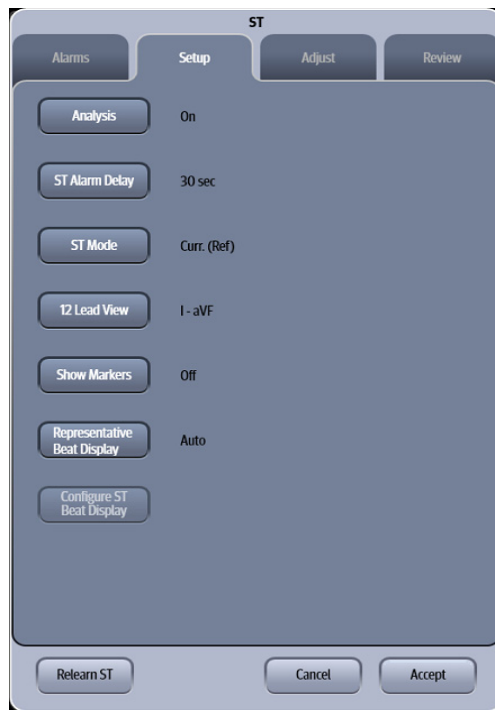

FIGURE 16-2 Example ST Dialog (Setup Tab)

3. Select the buttons described in TABLE 16-1 to configure the tab.

TABLE 16-1

BUTTON	DESCRIPTION / COMMENTS	CHOICES*
Analysis	Enables or disables ST analysis.	On, Off
ST Alarm Delay	Configures the delay time before calling an ST alarm.	30 seconds , 45 seconds, 1 minute, 90 seconds, 2 minutes, and 3 minutes
ST Mode	Configures whether Current and Reference digital data display in the ST Real-Time tile, or if only the Current digital data appears in the ST Real-Time tile.	Current , Curr.(Ref)
12 Lead View	When using a 12-lead cable type, configures which of the 12-leads are viewable in the tile.	1-aVF , V1-V6
Show Markers	When displaying the ST Rep Beat tile, this configures whether or not the ISO, J/ST points are shown in the tile	On, Off

* *The factory default configuration settings are in bold.*

TABLE 16-1 (Continued)

BUTTON	DESCRIPTION / COMMENTS	CHOICES*
Representative Beat Display	When using a cable type other than 3-lead, and using Auto mode, the leads display based on their deviation. The most deviated beat displays at the top, followed by second most deviated in the middle, followed by the third most deviated at the bottom. When using the Manual mode, the leads display according to the beat number selected in the Configure ST Beat Display option. Beat one displays as the top beat, beat two as the middle, and beat three at the bottom. NOTE: Switching leadsets or discharging a patient automatically reverts to the default of Auto.	Auto (which includes the 3 most deviated leads), Manual
Configure ST Beat Display	This button is only enabled when the Representative Beat Display is set to Manual. This configures which beats display in the ST Rep Beat tile.	Varies depending on the current lead set in use.

* The factory default configuration settings are in bold.

4. Select the **Cancel** or **Accept** button.
 - The **Cancel** button closes the dialog without saving the settings.
 - The **Accept** button saves the settings and closes the dialog.

16.2.4 Adjusting the ISO and J/ST Points

NOTE: When connected to a central monitoring system (i.e., central station), adjustments to ISO and J/ST points at the V 12/V 21 bedside monitor are updated at the central station if ST is enabled. Refer to the central station operating instructions for additional information.

1. Select the ST tile.
2. Select the **Adjust** tab (as shown in FIGURE 16-3).

NOTE: The current parameter setting displays in bold to the right of each button.

NOTE: When using a cable type other than 3-lead cable, the ST Adjust dialog displays two (2) valid representative beats as shown in FIGURE 16-3.

NOTE: When using a 3-lead cable, only one (1) representative beat displays.

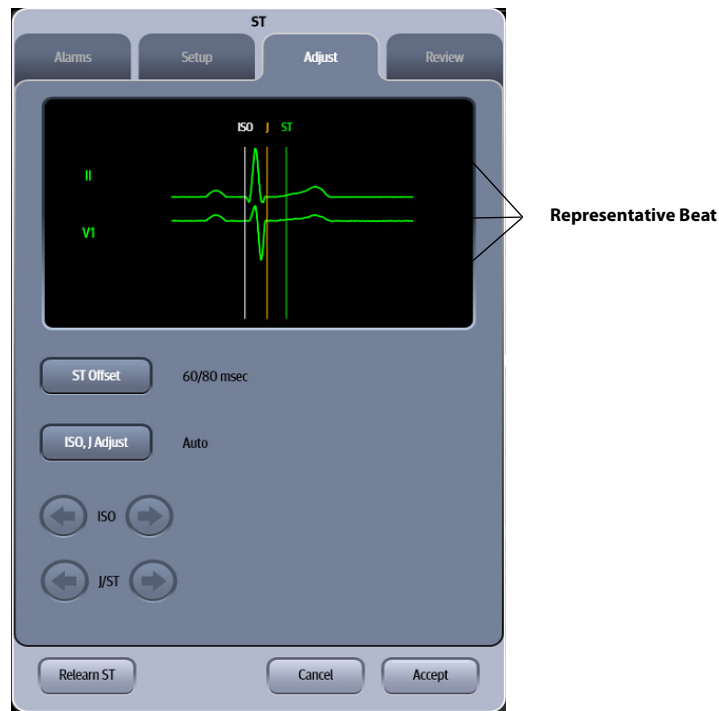

FIGURE 16-3 Example ST Dialog other than 3-lead (Adjust Tab)

3. Adjust the parameter using the tab buttons described in TABLE 16-2.

TABLE 16-2

BUTTON	DESCRIPTION / COMMENTS	OPTIONS*
ST Offset	Based on the msec setting selected, moves the ST point further or closer to the J point in the ST template.	60/80 msec , 40 msec, 60 msec, 80 msec
ISO, J Adjust	Selecting Auto fixes the ISO and J/ST points. Selecting Manual allows the clinician to manually adjust ISO and J/ST points.	Auto , Manual
NOTE: To adjust the ISO, J/ST points manually, the ISO, J Adjust must be set to Manual.		
ISO left arrow	If ISO, J Adjust is set to manual, the button adjusts the ISO reference line to the left.	
ISO right arrow	If ISO, J Adjust is set to manual, the button adjusts the ISO reference line right.	
J/ST left arrow	If ISO, J Adjust is set to manual, the button adjusts the J and ST reference lines left.	
J/ST right arrow	If ISO, J Adjust is set to manual, the button adjusts the J and ST reference lines right.	

* *The factory default configuration settings are in bold.*

4. Select **Accept** or **Cancel**.

- The **Accept** button saves the settings and closes the dialog.
- The **Cancel** button closes the dialog without saving the settings

16.2.5 Reviewing ST Points

1. Select the ST tile.
2. Select the **Review** tab.

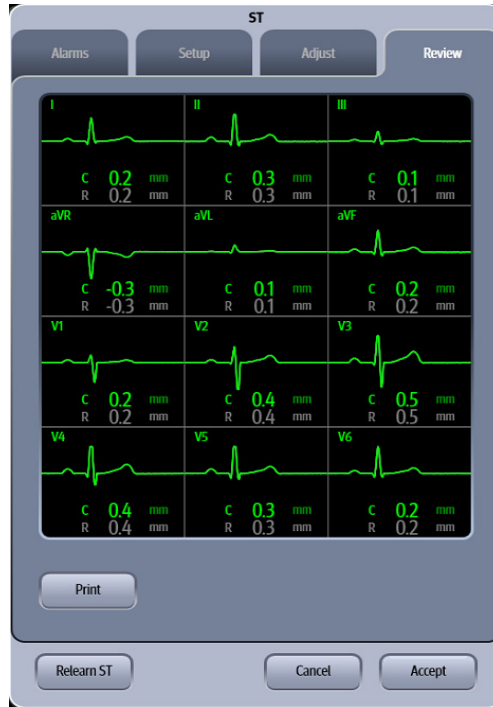

FIGURE 16-4 Example ST Dialog (Review Tab)

3. Select **Accept** or **Cancel**.
 - The **Accept** button saves the settings and closes the dialog.
 - The **Cancel** button closes the dialog without saving the settings

16.2.6 ST Relearning

NOTE: Selecting the **Relearn ST** button initiates the learning process for ST analysis.

The **V 12/V 21** initiates the learning process for ST or Arrhythmia analysis after one of the following:

- Unit power-up
- Return to normal monitoring from **Standby** mode
- After enabling ST or Arrhythmia analysis
- The lead has been changed in ECG 1 waveform (3 lead only)
- After selecting the **Relearn** button in the **ST**, **ECG**, or **Arrhythmia** tab.

Selecting the **Relearn** button is recommended after one or more of the following:

- ECG electrodes have been repositioned
- Eight hours have passed since the last relearn
- After significant changes to the patient QRS complex

- A clinician has observed clinically questionable arrhythmia calls
- Initiate a relearn if learning occurred during a leads off condition.
- The ECG lead set is manually changed at the bedside monitor.

16.3 ST Tile Layouts

The ST parameter is shown in a digital tile and a ST Rep (Representative) Beat format.

16.3.1 ST Digital Tile Layout

The ST digital tile displays:

1. Tile name
2. Message area
3. Units of measure
4. Lead identifier
5. Current and reference values

	I	II	III	aVR	aVL	aVF	V
C	0.2	0.3	0.1	-0.3	0.1	0.2	0.2
R	0.2	0.3	0.1	-0.3	0.1	0.2	0.2

FIGURE 16-5 Example 5-Lead ST Digital Tile

	I	II	III
C	-	0.3	-
R	-	0.3	-

FIGURE 16-6 Example 3-Lead Digital Tile

	I	II	III	aVR	aVL	aVF	Vx	Vy
C	0.3	0.4	0.1	-0.4	0.1	0.3	0.2	0.4
R	0.3	0.4	0.1	-0.4	0.1	0.3	0.2	0.4

FIGURE 16-7 Example 6-Lead Digital Tile

	I	II	III	aVR	aVL	aVF
C	0.2	0.3	0.1	-0.3	0.1	0.2
R	0.2	0.3	0.1	-0.3	0.1	0.2

FIGURE 16-8 Example 12-Lead Digital Half Tile

	I	II	III	aVR	aVL	aVF	V1	V2	V3	V4	V5	V6
Curr. (mm)	0.2	0.3	0.1	-0.3	0.1	0.2	0.2	0.2	0.4	0.5	0.3	0.4
Ref. (mm)	0.2	0.3	0.1	-0.3	0.1	0.2	0.2	0.2	0.4	0.5	0.3	0.4

FIGURE 16-9 Example 12-Lead Digital Full Tile

16.3.2 About the ST Tile

- Displays reference data when configured to include reference data in the **Setup** tab.
- Supports 3-lead, 5-lead, 6-lead, and 12-lead ECG configurations.
- When using a 3-lead set, one of vector I, II, or III display.
- When using a 5-lead set, vectors I, II, III, aVR, aVL, aVF, and V display in that order.
- When using a 6-lead set, vectors I, II, III, aVR, aVL, aVF, and Vx, and Vy display in that order.
- When using a 12-lead set, vectors I, II, III, aVR, aVL, and aVF display, in that order, when configured to display non-chest leads.
- When using a 12-lead set, vectors V1, V2, V3, V4, V5, and V6 display, in that order, when configured to display chest leads.
- When using a 12-lead set, vectors I, II, III, aVR, aVL, aVF, V1, V2, V3, V4, V5, and V6 display, in that order, when configured to display in expanded mode.

16.3.3 Message Area

The message area provides information about the current state of the ST parameter. If there is more than one message to display, the messages scroll.

MESSAGE	DETAILS
ST Single Alarm Violation	Indicates that the current value is either equal to, higher, or lower than the set alarm limits.
ST Dual Alarm Violation	Indicates that the current value is either equal to, higher, or lower than the set alarm limits.

16.3.4 ST Rep Beat Tile

The ST Rep (Representative) Beat tile displays the beats of the most deviated leads or the three selected leads.

The ST Rep Beat tile displays:

1. Tile name
2. Representative beat
3. Lead identifier
4. Current and reference values
5. Unit of measure
6. Current and reference labels
7. ST markers (ISO, J/ST)
8. Scale label

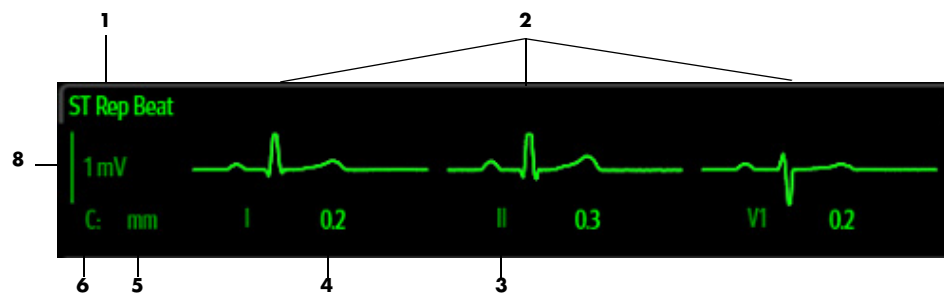

FIGURE 16-10 Example ST Rep Tile Layout (without Markers)



FIGURE 16-11 Example ST Rep Tile Layout (with Markers)

16.3.5 About the ST Rep Beat Tile

- The current numerics field indicates the most recent reading for each lead.
- The reference numerics field indicates the initial reading for each lead.
- The ST beat layout displays one (1) ST beat for 3-lead cable set.
- The ST beat layout displays three (3) ST beats for all cable sets excluding 3-lead.
- When the Representative Beat Display button (in the ST Setup tab) is set to Auto, the left most beat in the tile is the most deviated lead, with the second most deviated in the middle, followed by the third most deviated lead to the far right.
- When the Representative Beat Display button (in the ST Setup tab) is set to Manual, the left most beat in the tile is beat 1, followed by beat 2 in the middle, followed by beat 3 to the far right.

16.3.6 ST Alarms

Refer to the "Factory Default Alarm Limits" on page 8-4 for additional information.

16.4 ST Troubleshooting

The ST tile message area displays messages indicating the current state of the ST parameter. If there is more than one message to display, the messages scroll.

MESSAGE/PROBLEM	REASON	SOLUTION
Do not see ST parameter tiles in display.	Parameter not configured to display.	Refer to "Display Options Dialog" on page 3-2 for additional information.
Ref (reference) values not displaying	ST Mode is set to Current.	Change ST Mode from Current to Curr. (Ref). Refer to "Configuring the ST Parameter" on page 16-3 for additional information.
ST is configured to display in Main Screen but no ST values display in ST tiles.	ST Analysis is disabled.	Enable ST Analysis. Refer to "Configuring the ST Parameter" on page 16-3 for additional information.
ISO and J/ST arrow buttons are disabled in the ST dialog Adjust tab.	The ISO, J Adjust setting is configured for Auto.	Change the ISO, J Adjust setting to Manual. Refer to "Adjusting the ISO and J/ST Points" on page 16-5 for additional information.
The ST dialogs Relearn ST button is disabled.	ST Analysis is disabled.	Enable ST Analysis. Refer to "Configuring the ST Parameter" on page 16-3 for additional information.

This page intentionally left blank.

CO₂ Monitoring (Optional)

Introduction	17-2
CO2 Dialog	17-2
CO2 Tile Layouts	17-9
CO2 Troubleshooting	17-12

17.1 Introduction

This chapter describes the CO₂ parameter in detail, including monitoring CO₂, configuring alarm limits, and configuring the CO₂ parameter.

The **V 12/V 21** displays the ET CO₂ numeric, the Insp CO₂ numerics, and the CO₂ waveform when the CO₂ is being measured.

Patient Sizes

Intended patient types: Adult, Pediatric, Neonate.

CO₂ Module Connector

The VPS module does not include the CO₂ parameter. The CO₂ parameter is available as a separate module (as shown in FIGURE 17-1). Refer to "Taking a CO₂ Measurement" on page 17-7 for additional information.

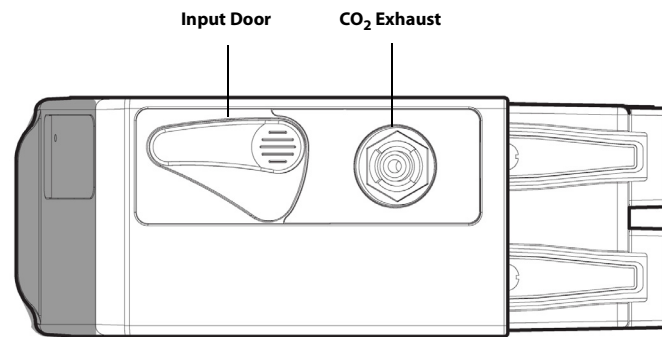

FIGURE 17-1 Example CO₂ Module Connector

Display Setup

To see the CO₂ values, CO₂ must be configured to display on the Main Screen. Refer to "Display Options Dialog" on page 3-2 for additional information.

17.2 CO₂ Dialog

The **CO₂** dialog (as shown in FIGURE 17-2) contains an **Alarms** tab, **Setup** tab, **Waveform** tab, and a **Calibrate** tab. A description of each tab follows.

17.2.1 Navigating to the CO₂ Dialog

- Select the CO₂ digital or waveform tile.

OR

1. Select the **Setup** tab from the Navigation Area.
2. Select the **Parameters** button.
3. Select the **CO₂** button.

The **CO₂** dialog displays (as shown in FIGURE 17-2).

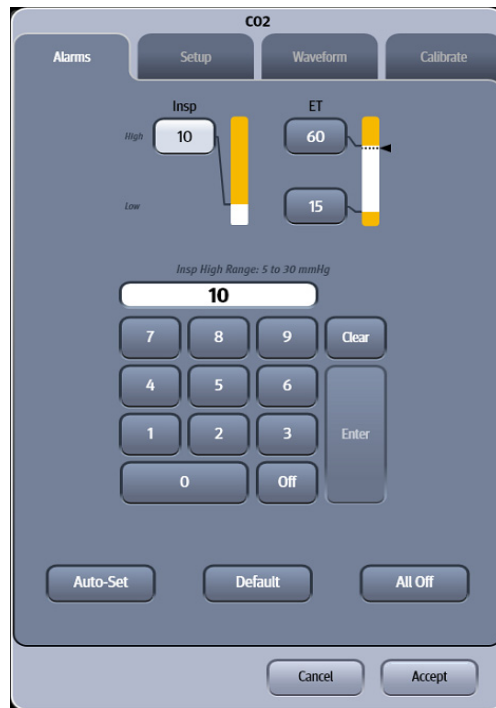

FIGURE 17-2 Example CO₂ Dialog (Alarms tab)

17.2.2 Configuring CO₂ Alarm Limits

Refer to "Configuring Alarm Limits" on page 8-2 for additional information.

17.2.3 Configuring the CO₂ Parameter Setup

1. Select the CO₂ digital or waveform tile.
2. Select the **Setup** tab (as shown in FIGURE 17-3).

NOTE: The current parameter setting displays in bold to the right of each button.

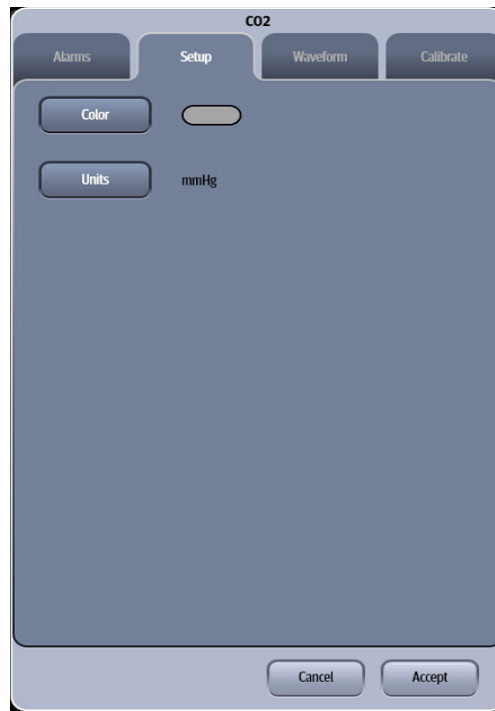

FIGURE 17-3 Example CO₂ Dialog (Setup Tab)

3. Select the buttons described in TABLE 17-1 to configure the tab.

TABLE 17-1

FUNCTION	DESCRIPTION	SETTINGS*
Color	Configures the CO ₂ parameter and waveform color.	16 distinct colors Default color is gray .
Units	Configures the units of measure for the CO ₂ parameter.	mmHg , %, kPa

* *The factory default configuration settings are in bold.*

4. Select the **Cancel** or **Accept** button.
 - The **Cancel** button closes the dialog without saving the settings.
 - The **Accept** button saves the settings and closes the dialog.

17.2.4 Configuring the CO₂ Waveform

1. Select the CO₂ digital or waveform tile.
2. Select the **Waveform** tab (as shown in FIGURE 17-4).

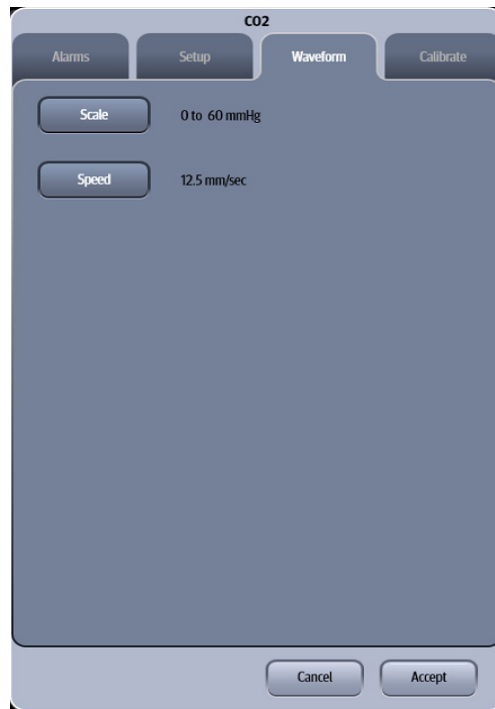

FIGURE 17-4 Example CO₂ Dialog (Waveform Tab)

3. Select the buttons described in TABLE 17-2 to configure the tab.

TABLE 17-2

FUNCTION	DESCRIPTION	SETTINGS*
Scale	Configures the CO ₂ waveform size or height.	0 to 40 mmHg, 0 to 60 mmHg 0 to 100 mmHg when CO ₂ units configured for mmHg 0% to 5%, 0% to 7.5% , 0% to 10% when CO ₂ units configured for % 0 to 5 kPa, 0 to 7.5 kPa , 0 to 10 kPa when CO ₂ units configured for kPa
Speed	Configures the waveform sweep speed.	3.125 mm/sec., 6.25 mm/sec., 12.5 mm/sec. , 25 mm/sec

* *The factory default configuration settings are in bold.*

4. Select the **Cancel** or **Accept** button.
- The **Cancel** button closes the dialog without saving the settings.
 - The **Accept** button saves the settings and closes the dialog.

17.2.5 Calibrating the CO₂ Module

Calibration is required when it has been more than one (1) year from the time of the last successful calibration or whenever the readings appear to be in error. The date of the last successful calibration displays in the CO₂ Calibration dialog.

NOTE: For maximum accuracy during calibration, a 20 minute warm-up time is recommended.

Tools required:

- Gas cylinder
- T-shape connector
- Tubing



FIGURE 17-5 Example CO₂ Dialog (Calibrate Tab)

1. Select the CO₂ digital or waveform tile. The CO₂ dialog displays (as shown in FIGURE 17-5).
2. Select the **Calibrate** tab.
3. Connect the gas cylinder with the tubing using a T-connector (as shown in FIGURE 17-6). Check the airway to ensure there are no leaks.

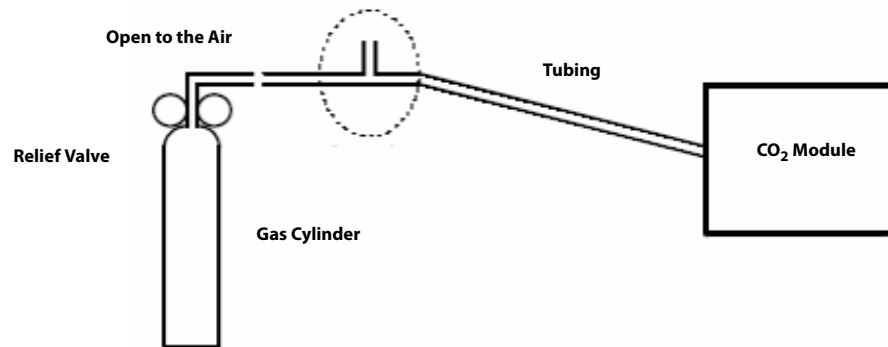

FIGURE 17-6

4. Open the relief valve to vent calibration gas, (P/N 0075-00-0033-01) and ensure that there is an excess gas flow through the T-shape connector to air and CO₂ reading is displayed during the calibration.
5. After the measured CO₂ concentration becomes stable, select **Start** to calibrate the CO₂ module, the message **Calibrating, continue to apply 5% CO₂** appears in the Calibration dialog. When the calibration completes, the message changes to Calculating, calibration gas can be removed. Turn off the button on the canister, and remove the connector.
6. After a moment, the message changes to **Calibration Completed Successfully CO₂**. The date and time of the successful calibration displays in the Calibration dialog.

NOTE: If no gas is being delivered, or the mixture does not contain 5% CO₂, the message "Calibration error. Caused by no gas or wrong gas concentration" will appear. In this case, perform another calibration.

7. Select the **Cancel** or **Accept** button.
 - The **Cancel** button closes the dialog without saving the settings.
 - The **Accept** button saves the settings and closes the dialog.

17.2.6 Taking a CO₂ Measurement

NOTE: When the caution message **Occlusion** displays, indicating that the **FilterLine** which is attached to the handheld monitor is blocked, the monitor's CO₂ pump stops pumping the patient's breath into the monitor for testing. First disconnect and reconnect the Filterline. If the message still displays, disconnect and replace the Filterline. Once a working Filterline is attached to the bedside monitor, the pump automatically resumes operations.

NOTE: During nebulization or suction for intubated patients, in order to avoid moisture buildup and sampling line occlusion, remove the sample line luer connector from the monitor.

1. Select the appropriate tubing for the patient.

NOTE: Replace the sampling line according to hospital protocol or when a blockage is indicated by the device. Excessive patient secretions or a build-up of liquids in the airway tubing may occlude the sampling line, requiring more frequent replacement.

2. Open CO₂ input door on the CO₂ module and connect the sensor. Connect the opposite end to the patient.

NOTE: **Ensure all tubing connections are secure.**

NOTE: **Consideration should be given to the disposal of packaging waste and calibration gases.**

3. After a warm-up period, the CO₂ waveform and digital CO₂ value display in the CO₂ tile.

17.2.7 CO₂ Sensors

Microstream-Oridion Medical and miniMediCO₂ module Microstream CO₂ modules provide **Expired CO₂**, **Inspired CO₂** and **Respiration Rate** monitoring utilizing a small lumen FilterLine[®]. Microstream capnography is accomplished via a nasal cannula (non-intubated) or through an adapter set for use in a breathing circuit (intubated). Microstream and can be used on adult, pediatric and neonatal patients.

NOTE: **When monitoring an anesthetized patient in an operating room environment, connection from the exhaust port of the V 12/V 21 to the hospital's waste gas scavenging system is recommended to prevent exposure of hospital personnel to the patient's respiratory sample.**

17.3 CO₂ Tile Layouts

The CO₂ parameter is shown in a digital tile and a waveform tile format

17.3.1 CO₂ Digital Tile Layout

The CO₂ digital tile displays:

1. Inspired CO₂ value
2. Message area
3. ET CO₂ value
4. CO₂ unit of measure
5. Resp unit of measure
6. Resp value
7. Source
8. High and low alarm limits



FIGURE 17-7 Example CO₂ Digital Tile

17.3.2 About the CO₂ Digital Tile

- If a CO₂ measurement is invalid, "--" displays in place of digits.
- The CO₂ tile displays all values in units of mmHg with a resolution of 1 mmHg when displayed in mmHg.
- The CO₂ tile displays all values in units of percent (%) with a resolution of 0.1% when displayed in percent.
- The CO₂ tile displays all values in units of kPa with a resolution of 0.1 kPa when displayed in kPa.

17.3.3 CO₂ Alarms

Refer to the "Gases Tab" on page 8-8 for additional information.

17.3.4 Message Area

The message area provides information about the current state of the CO₂ parameter. If there is more than one message to display, the messages scroll.

MESSAGE*	DETAILS
Inspired CO2 High Alarm Violation	Indicates that the current value is either equal to or higher than the set alarm limits.
ET CO2 High Alarm Violation	Indicates that the current value is either equal to or higher than the set alarm limits.
ET CO2 Low Alarm Violation	Indicates that the current value is either equal to or lower than the set alarm limits.
Resp High Alarm Violation	Indicates that the current value is either equal to or higher than the set alarm limits.
Resp Low Alarm Violation	Indicates that the current value is either equal to or lower than the set alarm limits.
Apnea Alarms	Displays during episodes of apnea.
NOTE: The Apnea alarm takes priority over the Low Respiration alarm.	
Filterline Disconnected	Filterline is disconnected from the monitor.
Warming Up	CO ₂ Operating lamp has not yet reached its operating temperature.
Auto Zero in Progress	CO ₂ module is performing zeroing out the values.
CO2 Failure	CO ₂ subsystem failed.
Check Flow Rate	CO ₂ flow rate is either low or high.
Occlusion	CO ₂ hardware indicates the filterline is blocked.
Purge	CO ₂ detects a fluid obstruction and attempts to purge by temporarily increasing the flow rate.
CO2 Not Calibrated	CO ₂ hardware indicates module is not calibrated.

17.3.5 CO₂ Waveform Tile Layout

The CO₂ waveform tile displays:

1. Tile name
2. CO₂ waveform
3. Waveform scale
4. Unit of measure

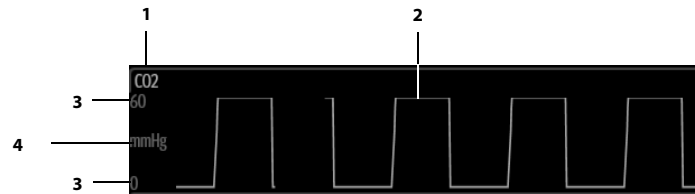

FIGURE 17-8 Example CO₂ Waveform Tile

17.3.6 About the CO₂ Waveform Tile

- The CO₂ waveform tile displays the waveform and the wave gain setting in the configured CO₂ color.
- Provides a scrolling, real-time waveform and an erase bar to provide a time indicator of oldest and new data.
- The CO₂ waveform tile rails the top most value when the waveform exceeds the upper scale limit for real-time waveforms.
- The CO₂ waveform tile rails the bottom most value when the waveform exceeds the lower scale limit for real-time waveforms.
- The CO₂ waveform tile displays the waveform at the configured waveform sweep speed.

17.3.7 Message Area

No messages display in the CO₂ waveform tile message area.

17.4 CO₂ Troubleshooting

The CO₂ tile message area displays messages indicating the current state of the CO₂ parameter. If there is more than one message to display, the messages scroll.

ISSUE	REASON	SOLUTION
Do not see CO ₂ parameter tiles in display.	Parameter not configured to display.	Refer to "Display Options Dialog" on page 3-2 for additional information.
"- -" displays in place of numerics.	Measurement is invalid.	Filter may be disconnected. Check patient.

Cardiac Output (CO) (Optional)

Introduction	18-2
Cardiac Output Dialog	18-2
Measuring CO	18-6
CO Digital Tile Layout	18-10
CO Troubleshooting	18-12

18.1 Introduction

This chapter describes the CO parameter in detail, including describing how to configure CO alarm limits, monitor CO, and configure the CO parameter settings (for example, height, weight and auto start).

Cardiac Output (CO) is the amount of blood ejected from the left ventricle each minute, expressed in liters per minute (l/min). Cardiac Index (CI) is the Cardiac Output divided by the patient's body surface area.

Patient Sizes

Intended patient types: Adult and Pediatric. The CO module is not available for Neonate patients.

CO Module Connector

The VPS module does not include the CO parameter. The CO parameter is available as a separate module (as shown in FIGURE 18-1). Refer to "Taking CO Measurements" on page 18-6 for additional information.

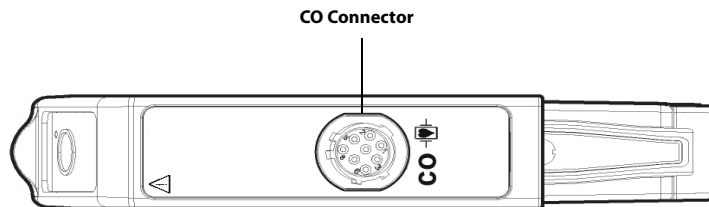

FIGURE 18-1 Example CO Module Connector

Display Setup

To see the CO/CI values, CO must be configured to display on the Main Screen. Refer to "Display Options Dialog" on page 3-2 for additional information.

18.2 Cardiac Output Dialog

The Cardiac Output dialog (as shown in FIGURE 18-2) contains an **Alarms** tab and **Setup** tab. A description of each tab follows.

18.2.1 Navigating to the Cardiac Output Dialog

- Select the CO digital tile.

OR

1. Select the **Setup** tab from the Navigation Area.
2. Select the **Parameters** button.
3. Select the **CO** button.

The Cardiac Output dialog displays (as shown in FIGURE 18-2).

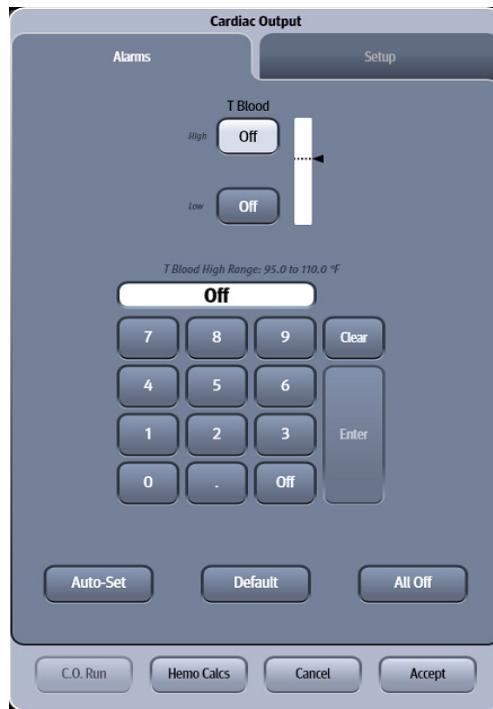

FIGURE 18-2 Example Cardiac Output Dialog (Alarms tab)

18.2.2 Configuring T Blood Alarm Limits

There are no alarm limits settings for Cardiac Output. The alarm limits are for blood temperature or T Blood. Refer to "Configuring Alarm Limits" on page 8-2 for additional information.

18.2.3 Configuring the CO Parameter

1. Select the CO digital tile.
2. Select the **Setup** tab (as shown in FIGURE 18-3).

NOTE: The current parameter setting displays in bold to the right of each button.

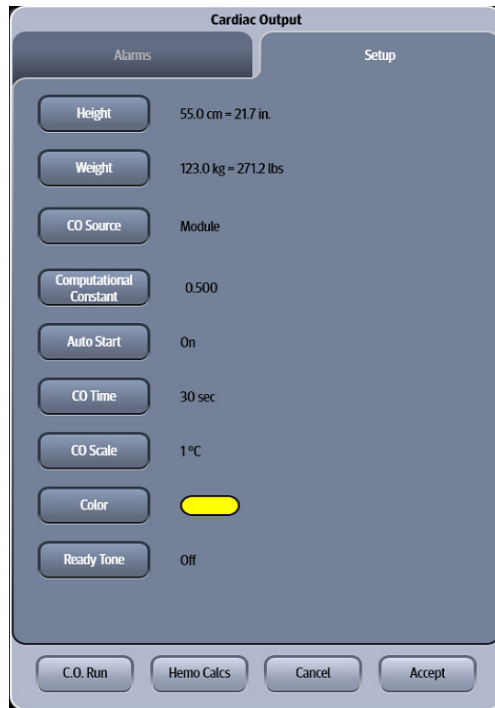

FIGURE 18-3 Example Cardiac Output Dialog (Setup Tab)

3. Select the buttons described in TABLE 18-1 to configure the tab.

TABLE 18-1

FUNCTION	DESCRIPTION	SETTINGS*
Height	Opens the digital keypad to enter the patient's height.	Unspecified
Weight	Opens the digital keypad to enter the patient's weight.	Unspecified
NOTE: Enter the patient's height and weight to calculate the Cardiac Index (CI). The cardiac index cannot be calculated without it.		
CO Source	Configures the CO source.	Auto, Module, and External
NOTE: In Auto Start mode, if both a CO module is present and an external CO device, the external CO device takes priority over the CO module.		
Computational Constant	Verify the correct computation is used based on the PA manufacturers instructions.	0.001 to 1.000 in steps of 0.001 Default: 0.500

* *The factory default configuration settings are in bold.*

TABLE 18-1

FUNCTION	DESCRIPTION	SETTINGS*
Auto Start	When Auto Start is enabled, the monitor automatically takes the CO measurement after establishing a baseline blood temperature. In this mode, it is not necessary to select the Start CO button in the CO Run dialog. When Auto Start is disabled, the clinician must manually select the Start CO button in the CO Run dialog in order for the monitor to begin a CO Run.	On, Off
CO Time	Configures the time scale in the CO Run window.	30 seconds , 60 seconds
CO Scale	Configures the temperature scale in the CO Run window.	0.5 °C, 1°C , 2 °C, 4 °C
Color	Configures the color of the digital data in the CO digital tile.	16 distinct colors Factory default color is yellow .
Ready Tone	Provides an audible indication that the monitor is ready to begin a CO run. This allows the clinician to know a CO run can be started without actively viewing the monitor.	On, Off

* *The factory default configuration settings are in bold.*

4. Select the **Cancel** or **Accept** button.
 - The **Cancel** button closes the dialog without saving the settings.
 - The **Accept** button saves the settings and closes the dialog.

18.3 Measuring CO

18.3.1 Optimizing CO Measurements

1. From the PA catheter package insert, verify the correct computation constant for the catheter type, injectate volume, and injectate temperature. Change the computation constant if it is different than the monitor's factory default of 0.500.
2. Verify proper PA catheter positioning.
3. Purge system of air.
4. Use correct injectate port.

18.3.2 Auto and Manual CO Measurements

In **Auto Start** mode (when **Auto Start** is set to **On**), the monitor automatically takes the CO measurement after establishing a baseline blood temperature. In this mode, it is not necessary to select the **Start CO** button in the CO Run dialog. After a bolus injection, the **V 12/V 21** computes the CO and is ready to start another bolus injection.

In **Manual** mode (when **Auto Start** is set to **Off**), the monitor takes the CO measurement after selecting the **Start CO** button in the CO Run dialog. After a bolus injection, the **V 12/V 21** computes the CO and is ready to start another bolus injection.

18.3.3 Taking CO Measurements

1. Connect the CO cable to the CO connector in the CO module.
2. If not previously done, follow the steps in the "Configuring the CO Parameter" on page 18-3 or skip to following step.
3. Select the CO digital tile.
4. Select the **Setup** tab.
5. Enter the Height, Weight, and CO Source.
6. Select the **C.O. Run** button.
The Cardiac Output dialog displays (shown in FIGURE 18-4).

NOTE: **CCO measurements take precedence over CO measurements. If you are using both CO and CCO, and want to take a CO measurement, change the CO Source to Module and then run the measurement. To reengage CCO as the priority measurement, change the CO Source to Auto.**

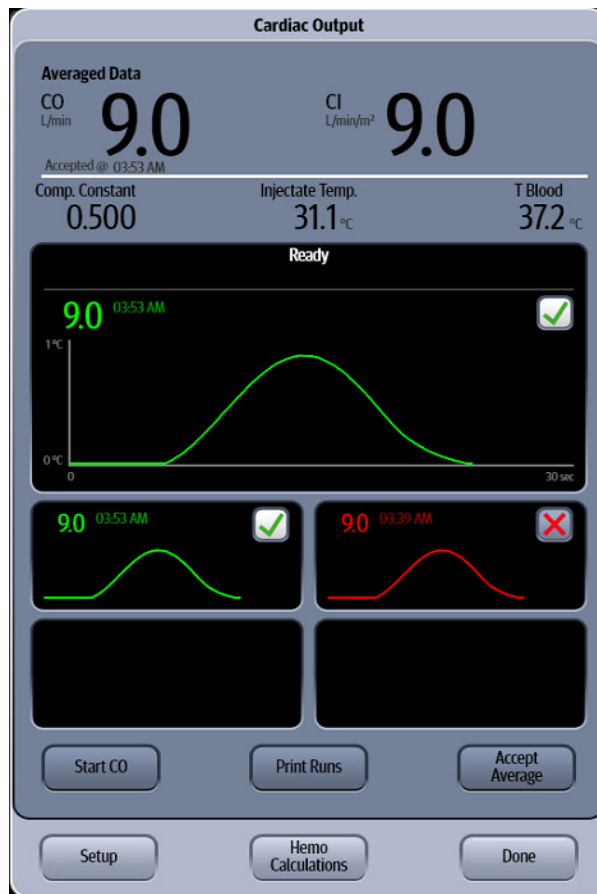

FIGURE 18-4 Example CO Run dialog

7. Start the measurement:
 - If Auto Start is set to **On**, the measurement automatically begins after establishing a baseline blood temperature.
 - If Auto Start is set to **Off**, prepare the injectate, then select the **Start CO** button.

NOTE: The **Start CO** button changes to **Stop CO** once it is selected.



8. Once injecting the bolus, the CO curve appears, and the CO measurement displays.

NOTE: If a measurement is compromised, as indicated by an Irregular Curve or error alert message, the curve displays in red and a red  displays in the box (as shown in FIGURE 18-4).

9. Note the injectate temperature and verify that the correct computation constant was selected.
10. Perform subsequent cardiac output runs as needed.

NOTE: Any run with an invalid CO value is excluded from the averaged CO value.

11. Once a sufficient number of CO runs are complete, select the **Accept Average** button to calculate the averaged data.

NOTE: Runs containing green waveform data and a  in the upper right corner of the run indicate that the measurement was included in the average. Runs containing red waveform data and a red  in the upper right corner of the run indicate that the measurement was not included in the average.

12. Optional - select the **Print Runs** button to print the CO run(s) to the thermal printer.

NOTE: If there is no thermal printer installed, the CO runs will not print.

13. Optional - select the **Hemo Calculations** button to open the Hemodynamics dialog and perform a calculation.

NOTE: Refer to "Hemodynamics Dialog" on page 21-2 for additional information.

14. Select the **Done** button.

18.3.3.1 About the Cardiac Output Dialog

- The Cardiac Output dialog displays one (1) current run and four (4) historical runs.
- The averaged CO/CI values are updated as runs are excluded and included.
- Runs in error are not included in the CO average.
- Only runs containing valid CO values are included in the average.
- Once a CO average is accepted, it cannot be edited.

18.3.3.2 Cardiac Output Dialog Messages

- There are three types of CO messages: error, alert, and procedural prompts.
- Error messages and alert messages display at the completion of a CO run.
- Error messages have priority over alert messages.
- If multiple alert messages occur at the same time, the messages will alternate every two (2) seconds.
- Only one procedural prompt displays at a time.

NOTE: Refer to "CO Troubleshooting" on page 18-12 for assistance in resolving these issues.

MESSAGE CATEGORY	MESSAGE TYPE
Error	Signal Under Range
Alert	Noisy Baseline
	Irregular Curve
	Delayed Injection
	Injectate Temperature Error
Procedural Prompts	Check Catheter
	Injectate Temperature Out of Range
	Please Wait
	Inject Now
	Measuring

MESSAGE CATEGORY	MESSAGE TYPE
	Ready
	Inject When Ready

18.4 CO Digital Tile Layout

The CO digital tile displays:

1. CO/CI tile label
2. Message area
3. CI value
4. High and low alarm limits
5. Units of measure
6. TBlood value
7. TBlood label
8. CO timestamp
9. CO source
10. CO value

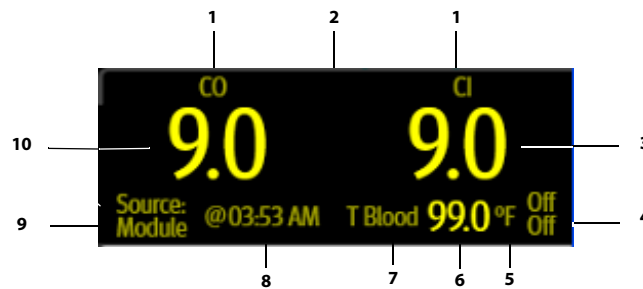

FIGURE 18-5 Example CO Digital Tile

18.4.1 About the CO Tile

CO and CI Parameter

- The CO parameter displays CO in units of l/min with a resolution of 0.1 l/min.
- The CI parameter displays CI in units of l/min/m² with a resolution of 0.1 l/min/m².
- If the CO/CI measurement is invalid, "--" displays in place of digits.
- The CO tile displays a timestamp.

NOTE: The timestamp only displays after accepting a CO average.

TBlood Parameter

- The TBlood parameter displays TBlood in the configured units of measure, with a resolution of 0.1°C when the unit of measure is Celsius and 0.1°F when the unit of measure is Fahrenheit.
- If the TBlood measurement is invalid, "--" displays in place of digitals.

18.4.2 CO Alarms

Refer to the "Temp Tab" on page 8-6 for additional information.

18.4.3 Message Area

The message area provides information about the current state of the CO function. If there is more than one message to display, the messages scroll.

MESSAGE	DETAILS
TBlood High Alarm Violation	Indicates that the current value is either equal to or higher than the set alarm limits.
TBlood Low Alarm Violation	Indicates that the current value is either equal to or lower than the set alarm limits.
Check Vigilance	Indicates that there is an error condition at the external device that may have an impact on the CO data displayed at the V 12/V 21 .

NOTE: **This message only displays when the CO Source is set to Auto or External.**

18.5 CO Troubleshooting

The CO tile message area displays messages indicating the current state of the CO parameter. If there is more than one message to display, the messages scroll.

MESSAGE/PROBLEM	REASON	SOLUTION
Do not see CO parameter tiles in display.	Parameter not configured to display.	Refer to "Display Options Dialog" on page 3-2 for additional information.
CO value higher / lower than expected	Computation constant incorrect for PA catheter type, injectate temperature, and injectate volume.	Check computation constant and enter correct data.
	Catheter may be kinked or not in proper position.	Notify physician.
C.O. Run button disabled	CO module not seated properly.	Re-seat the CO module.
	CCO and CO modules engaged.	To take a CO measurement, change the CO Source to Module.
	Patient's height and weight not entered.	Enter the patient's height and weight.
No measurement/ Unable to measure	Unstable temperature.	Check injectate temperature.
	No temperature or temperature out of range.	Flush PA catheter.
	Time elapsed for measurement.	Discard bolus fluid. Check patient. Wait for Ready or Inject when Ready message to appear. Rebolus when ready.
CO Signal Under Range	Appears if the CO curve is not sufficient for a CO calculation or if a curve is not detected within thirty (30) seconds.	Rebolus if necessary
CO Out of Range	Appears if the CO is out of the measurable range (0.2 l/min to 20.0 l/min). Computation constant incorrect for PA catheter type, injectate temperature, and injectate volume.	Check computation constant and enter correct data. Rebolus when ready.
Irregular curve	Improper injection procedure.	Check hospital policy, inject in a smooth and fluid bolus.
	Catheter may be kinked or not in proper position.	Notify physician.
	Patient movement during injection.	Have patient lay still during bolus procedure.
	Measurement displayed if CO curve has multiple peaks, failure to return to baseline or irregularities in curve.	Rebolus when ready
Delayed Injection	Appears if the time between the start of the CO measurement and the onset of the temperature change is more than fifteen (15) seconds	Rebolus when ready.
		Ensure that the CO bolus is initiated within 15 seconds Check the temperature of the injectate

MESSAGE/PROBLEM	REASON	SOLUTION
Injectate Temp Error	Appears when the temperature of the injectate is too warm (>27°C) or the difference between the injectate and the blood temperature is <8°C.	Check injectate fluid, insure fluid is not under warm lights, near a warming blanket or another warm source.
Noisy Baseline	Cardiac Output waveform baseline is unstable.	Rebolus when ready.
Measuring	Displays once an injection is detected during the process of a CO run.	Wait until measurement completes before continuing.
Injectate Temp. Out of Range	Displays when the temperature of the injectate is too warm (>27°C) or the difference between the injectate and the blood temperature is <8°C.	Check injectate fluid, insure fluid is not under warm lights, near a warming blanket or over-chilled in the ice bath.
Inject When Ready	Displays if Auto Start is enabled, stable temperatures are detected	Bolus when ready.
Ready	Displays if Auto Start is not enabled, and stable temperatures are detected	Press Start CO when ready.
Inject Now	Displays once Start CO has been pressed, before bolus is initiated	Bolus when ready.
Please Wait	Displays after fluid bolus is initiated and Cardiac Output is being calculated	Wait until message disappears.

This page intentionally left blank.

Reports

Introduction	19-2
Print Setup.....	19-2
Print Queue.....	19-7
Internal Recorder (Optional)	19-8
Laser Printer Reports	19-9
Printing Troubleshooting	19-46

19.1 Introduction

This chapter describes the **V 12/V 21** reports and provides instructions on how to generate them from the laser printer and thermal printer module.

Patient Sizes

Intended patient types for all these reports are Adult, Pediatric, and Neonate except when specified.

19.2 Print Setup

The Print Setup dialog controls which waveforms print in the waveform reports (for example, Waveform Report, Event Detail Report). It also controls how often a waveform report prints when configured for interval printing, and whether the report will print to the laser or thermal printer.

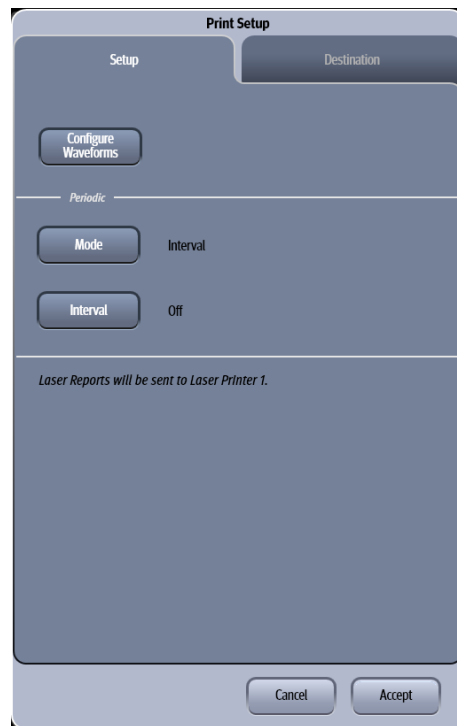

FIGURE 19-1 Example Print Setup Dialog

19.2.1 Navigating to the Print Setup Dialog

1. Select the **Print** tab from the Navigation Area.
2. Select the **Print Setup** button.
The Print Setup dialog displays (as shown in FIGURE 19-1).

19.2.2 Configuring the Print Setup

1. Select the **Print** tab from the Navigation Area.
2. Select the **Print Setup** button.
3. Select the buttons described in TABLE 19-1 to configure the tab.

TABLE 19-1

BUTTON	DESCRIPTION / COMMENTS	CHOICES*
Configure Waveforms	Selects which waveforms print and in which order the waveforms print in the waveform reports.	ECG 1, ECG II, ECG III, ECG aVR, ECG aVF, ECG aVL, ECG V/Vx/V1, ECG Vy/V2, ECG V3, ECG V4, ECG V5, ECG V6, SpO2, Resp, CO2, IBP1-8. Refer to "Configuring the Waveforms to Print" on page 19-4 for additional information.
Mode	Determines if the reports are printed by a set interval or by the clock.	Interval , Clock
Interval	Determines how often a waveform report will automatically be printed.	Off , 30 min, 1hr, 2hrs, 4hrs, 8hrs, 12hrs
NOTE: The Interval setting does not limit the ability to print on demand or interfere with the Print on Alarm feature.		

* *The factory default configuration settings are in bold.*

4. Select the **Cancel** or **Accept** button.
 - The **Cancel** button closes the dialog without saving the settings.
 - The **Accept** button saves the settings and closes the dialog.

19.2.3 Configuring the Waveforms to Print

1. Select the **Print** tab from the Navigation Area.
2. Select the **Print Setup** button.
3. Select the **Configure Waveforms** button.
The Waveform Configuration dialog displays (as shown in FIGURE 19-2).

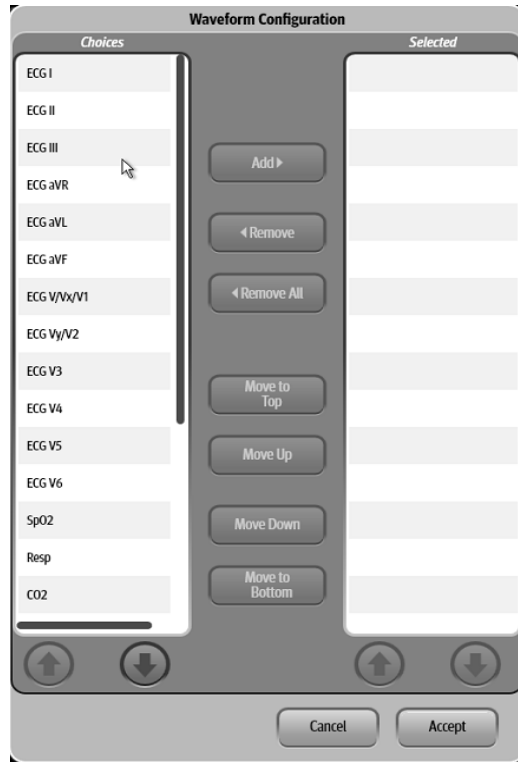



FIGURE 19-2 Example Waveform Configuration Dialog

4. Navigate in this dialog by using the buttons described in TABLE 19-2.

TABLE 19-2

BUTTON	DESCRIPTION
Add	Adds the highlighted parameter(s) to the Selected list (located on the right side of the dialog).
	NOTE: Multiple parameters may be highlighted in the list before selecting the button.
Remove	Removes the highlighted parameter(s) from the Selected list and moves them to the Choices list.
Remove All	Removes all the selected parameters from the Selected list and moves them to the Choices list.
Move to Top	Moves the selected parameter to the top position in the Selected list.
Move Up	Moves the selected parameter up one position in the Selected list.

TABLE 19-2

BUTTON	DESCRIPTION
Move Down	Moves the selected parameter from the Selected list down one position.
Move to Bottom	Moves the selected parameter to the bottom position in the Selected list.
	Scrolls up the Choices or Selected lists.
	Scrolls down the Choices or Selected lists.

5. Continue to select the **Cancel** or **Accept** button to return to the Main display.
 - The **Cancel** button closes the dialog without saving the settings.
 - The **Accept** button saves the settings and closes the dialog.

19.2.4 Configuring the Print Destination

1. Select the **Print** tab from the Navigation Area.
2. Select the **Print Setup** button.
3. Select the **Destination** tab.
The Destination tab displays (shown in FIGURE 19-3)

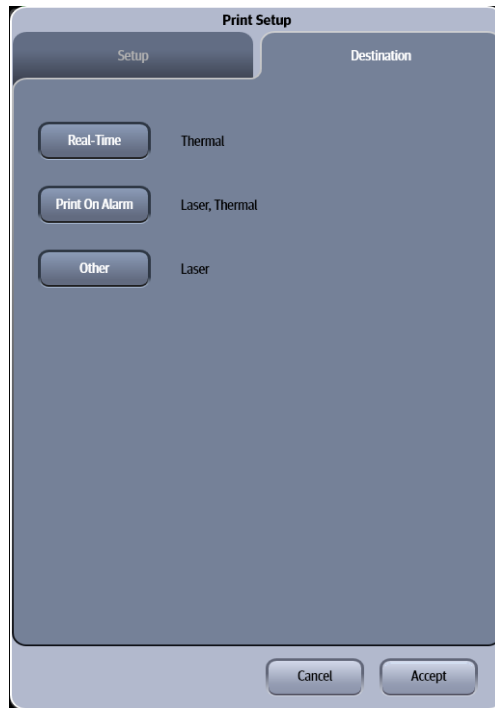

FIGURE 19-3 Example Print Setup Dialog (Destination Tab)

4. Select the buttons described in TABLE 19-3 to configure the tab.

TABLE 19-3

BUTTON	DESCRIPTION / COMMENTS	CHOICES*
Real-Time	Determines where the waveform and strip reports print.	Laser, Thermal , or Laser, Thermal
Print On Alarm	Determines where the report prints if the Print on Alarm option is enabled in the Alarm Responses tab.	Laser, Thermal, or Laser, Thermal
Other	Determines where the historical reports and miscellaneous reports (for example, Drug Calculations Report and Hemodynamic Calculations Report) print.	Laser , Thermal, or Laser, Thermal

* The factory default configuration settings are in bold.

5. Select the **Cancel** or **Accept** button.
- The **Cancel** button closes the dialog without saving the settings.
 - The **Accept** button saves the settings and closes the dialog.

19.3 Print Queue

The Print Queue dialog displays all the current print requests. From this dialog, view all print requests and delete current print requests.

NOTE: The print queue displays the 10 most recent print requests.

19.3.1 Navigating to the Print Queue Dialog

1. Select the **Print** tab from the Navigation Area.
2. Select the **Print Queue** button.
The Print Queue dialog displays (as shown in FIGURE 19-4).

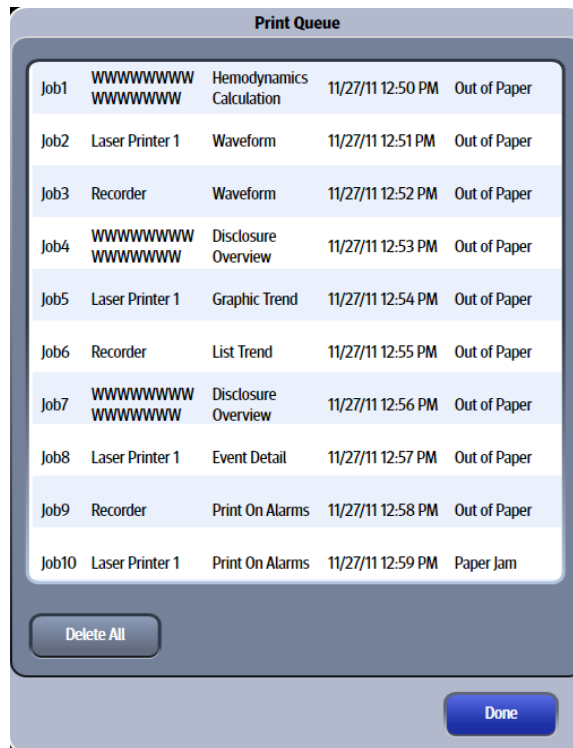

FIGURE 19-4 Example Print Queue Dialog

19.3.2 Deleting all Print Requests

1. Select the **Print** tab from the Navigation Area.
2. Select the **Print Queue** button.

NOTE: The **Delete All** button is only enabled if there are print requests in the queue.

3. Select the **Delete All** button.
All the print requests are deleted from the queue.
4. Select the **Done** button.

19.4 Internal Recorder (Optional)

The **V 12/V 21** thermal printer is a strip chart recorder with an integral paper spool. The recorder uses only Mindray thermal paper P/N 0683-00-0422-10 (box of 10) or P/N 0683-00-0422-01 (single roll).

NOTE: Refer to "Installing the Thermal Recorder Paper" on page 4-27 for additional information.

NOTE: All grid patterns and data are printed by the recorder.

The following reports are available from the recorder:

- ECG Strip
- List Trend Strip
- Disclosure Detail Strip
- Event List Strip
- Event Detail Strip
- Print on Alarm Strip
- ST Strip
- Drug Calculation Strip
- Hemodynamic Calculations Strip
- Quick Trend Strip
- CO Strip
- Continuous ECG Strip
- Graphic Trend Strip

19.4.1 Printing to the Thermal Recorder

Once the print destination is defined, follow the printing directions in the Laser Printer Reports section to print any (with the exception of the ECG Strip) of the strips to the thermal printer.

NOTE: Refer to "Configuring the Print Destination" on page 19-5 for additional information.

19.4.2 Printing an ECG Strip

To print a single strip

- Press the  button on the thermal recorder to print an ECG strip.
Optional - press the button a second time to stop printing.

To print continuous strips

1. Select **Print** from the Navigation Area.
2. Select the **Continuous** button.
The strips begin to print to the thermal printer and the **Continuous** button changes to **Abort Continuous**.
3. Select the **Abort** button to stop the printing.

19.5 Laser Printer Reports

19.5.1 Waveform Report

NOTE: Contact your System Administrator to find out where the laser printer is setup on the network.

NOTE: This report contains waveforms. To configure which waveforms print in the report, refer to "Configuring the Waveforms to Print" on page 19-4.

NOTE: This report may also be printed from the thermal printer. Refer to "Configuring the Print Destination" on page 19-5 for additional information.

The Waveform Report (as shown in FIGURE 19-5) prints 10 seconds of the configured waveforms plus all the other parameters being monitored at the time the report was initiated. A marker (shown as a triangle ▼) displays above the waveform grid indicating the date and time the data was recorded. This report includes a header, waveform information, digital parameter values, and a footer.

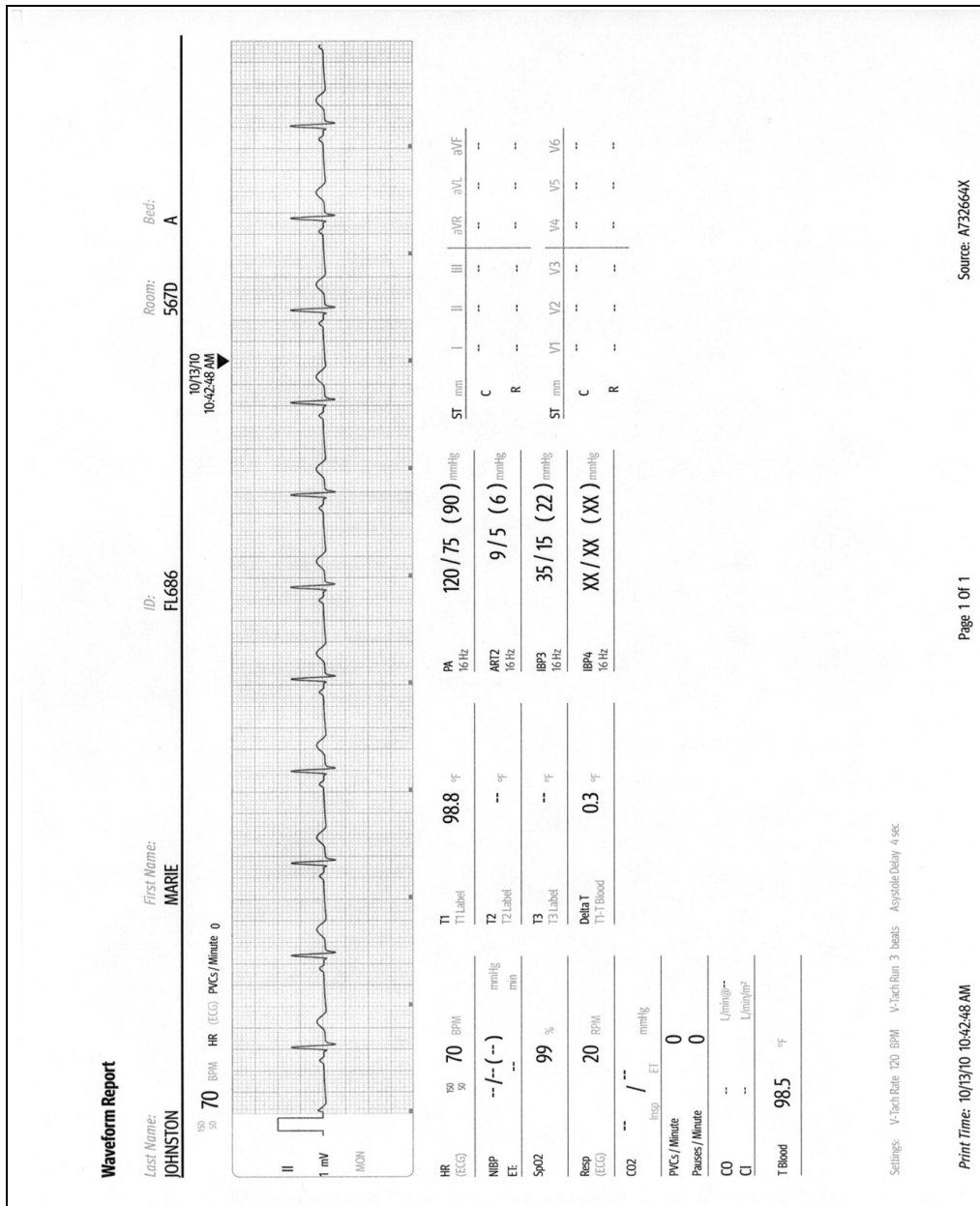

FIGURE 19-5 Example Waveform Report (Laser Printer Output)

19.5.1.1 Printing a Waveform Report

1. Select the **Strip** button in the Navigation Area. A pop-up menu displays.
2. Select Waveform to print the Waveform Report. The report prints.

19.5.2 12 Lead Report

The 12 Lead Report includes two formats: Standard Report and Median Complexes and Matrix Report.

19.5.2.1 Standard Report

The 12 Lead Report (as shown in FIGURE 19-6) provides 12 leads of ECG data for the selected patient. This report includes a header, waveform data, and a footer. The header provides the information for the selected patient, the measured parameter values and the selected QTc formulas, and critical value interpretation results.

For additional information about critical value and diagnosis, refer to the **Glasgow Program Physician's Guide** (P/N 046-004985-00)

NOTE: The ECG Cable Type must be set for 12 Lead. Refer to "Configuring ECG Setup" on page 9-5 for additional information.

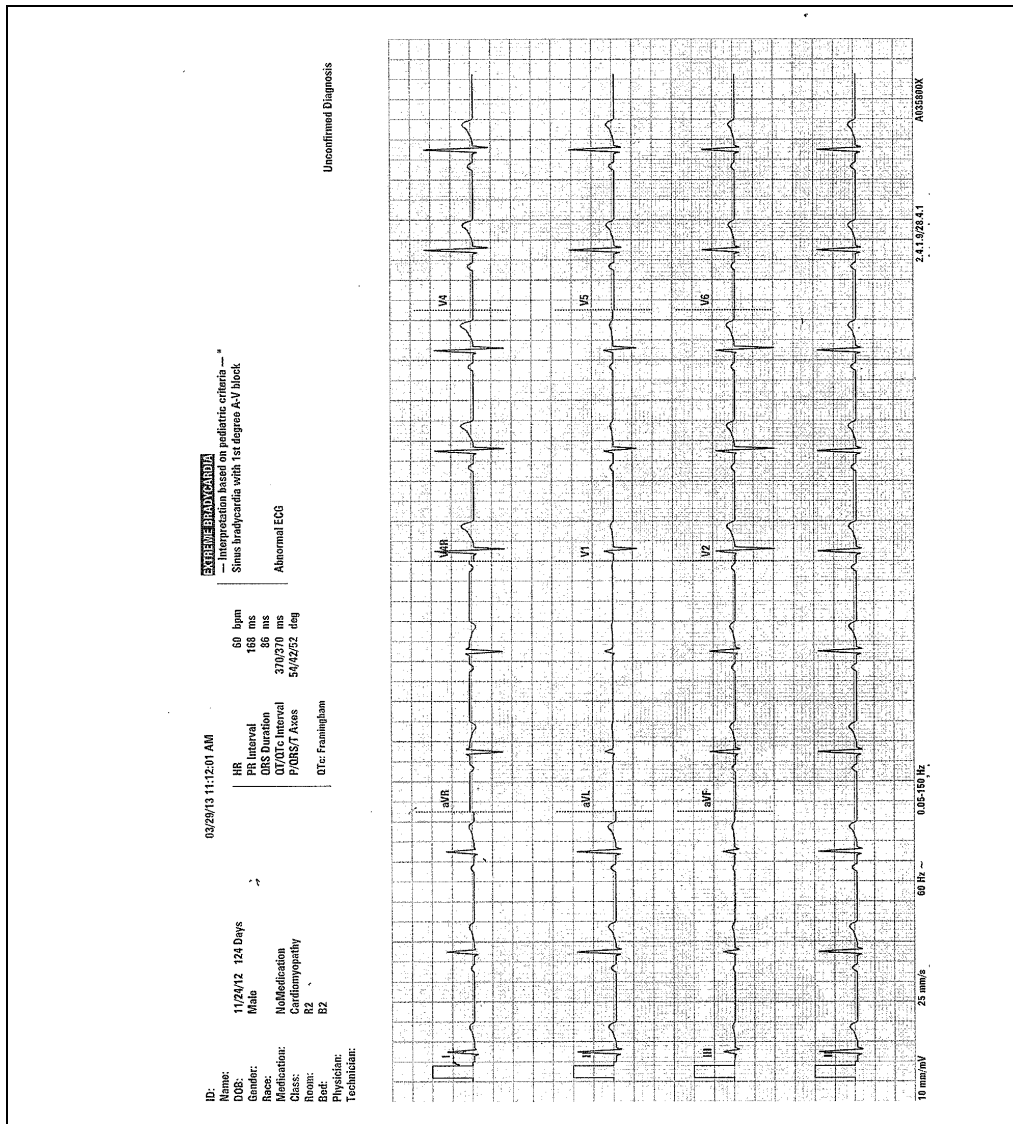

FIGURE 19-6 Example 12 Lead Standard Report (Laser Printer Output)

Printing the Standard Report

1. Select the **Procedures** tab from the Navigation Area.
2. Select the **12 Lead** button.
3. Select the **Advanced** tab.
4. Select **Standard** from the **Report Format** button.
5. Select the **Print 12 Lead** button.
The report prints.

NOTE: If the ECG Management system is configured On, the 12 Lead interpretation as XML format will be exported to the specified file path. Refer to "Configuring ECG Management Setup" on page 25-13 for additional information.

NOTE: If there are any errors detected while exporting the 12 Lead Interpretation, the system displays a confirmation dialog.

19.5.2.2 Median Complexes and Matrix Report

This report includes three pages: the Standard page, the Median Complexes page, and the Measurement Matrix page (as shown FIGURE 19-6, FIGURE 19-7, and FIGURE 19-8).

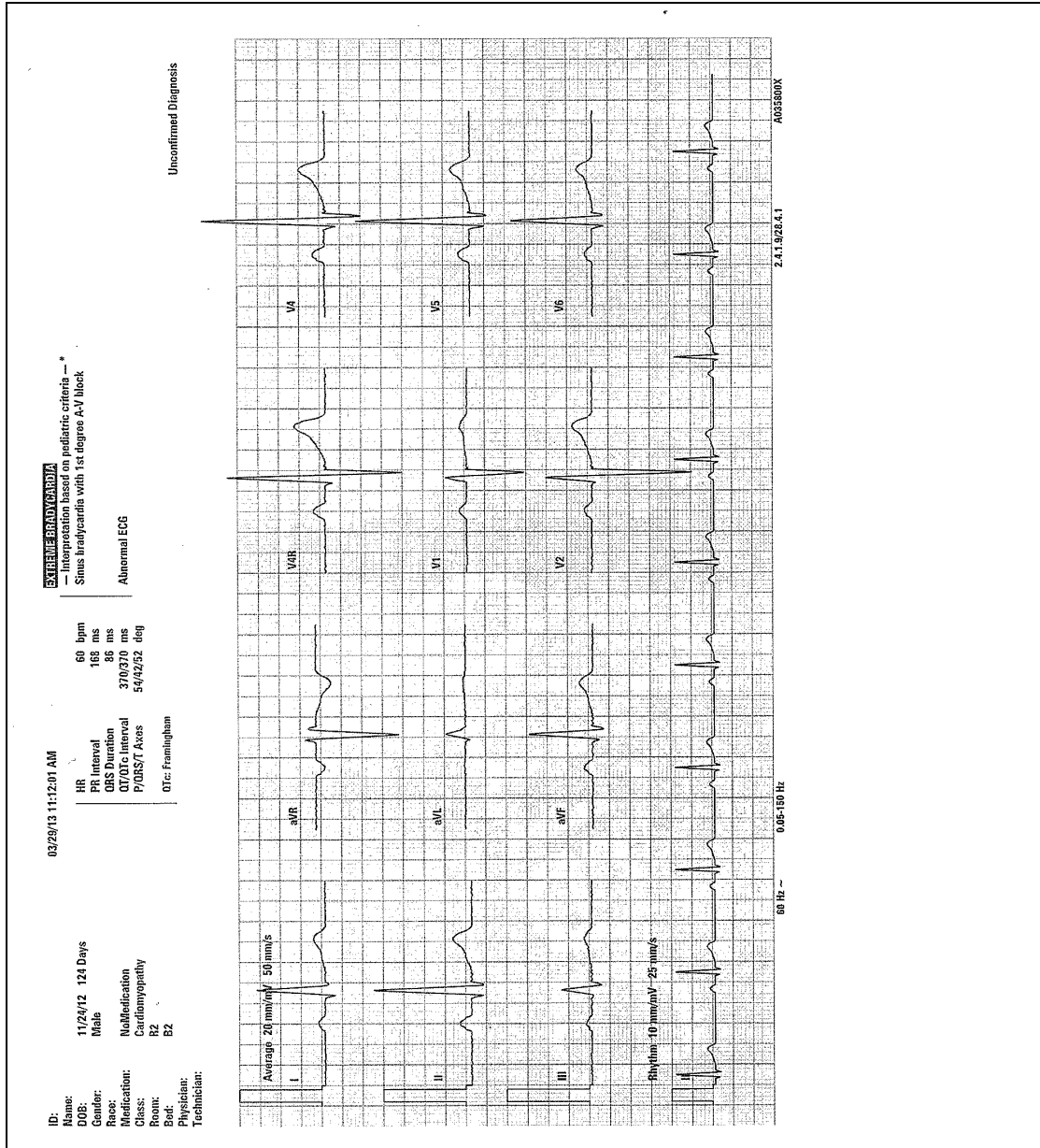

FIGURE 19-7 Example 12 Lead Median Complexes and Matrix Report (Median Complexes page)

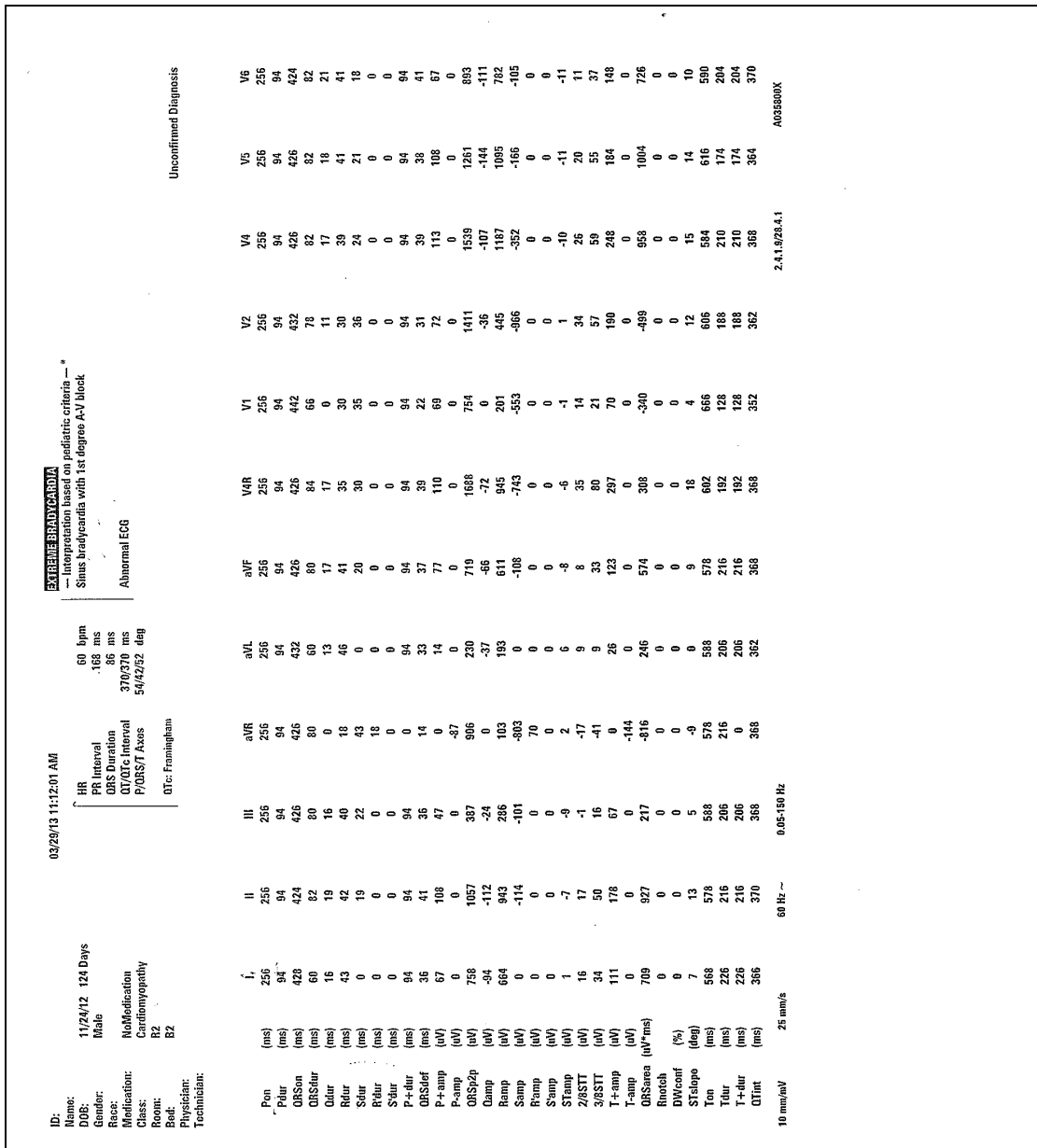

FIGURE 19-8 Example 12 Lead Median Complexes and Matrix Report (Measurement Matrix page)

Printing the Median Complexes and Matrix Report

1. Select the **Procedures** tab from the Navigation Area.
2. Select the **12 Lead** button.
3. Select the **Advanced** tab.
4. Select **Median Complexes and Matrix** from the **Report Format** button.
5. Select the **Print 12 Lead** button.
The report prints.

19.5.3 List Trend Report

The List Trend Report (as shown in FIGURE 19-9) shows a patient's historical trended digital data for a 1, 2, 4, 8, 12 or 24 hour time period. This report includes a header, trend records, and a footer.

NOTE: This report may also be printed from the thermal printer. Refer to "Configuring the Print Destination" on page 19-5 for additional information.

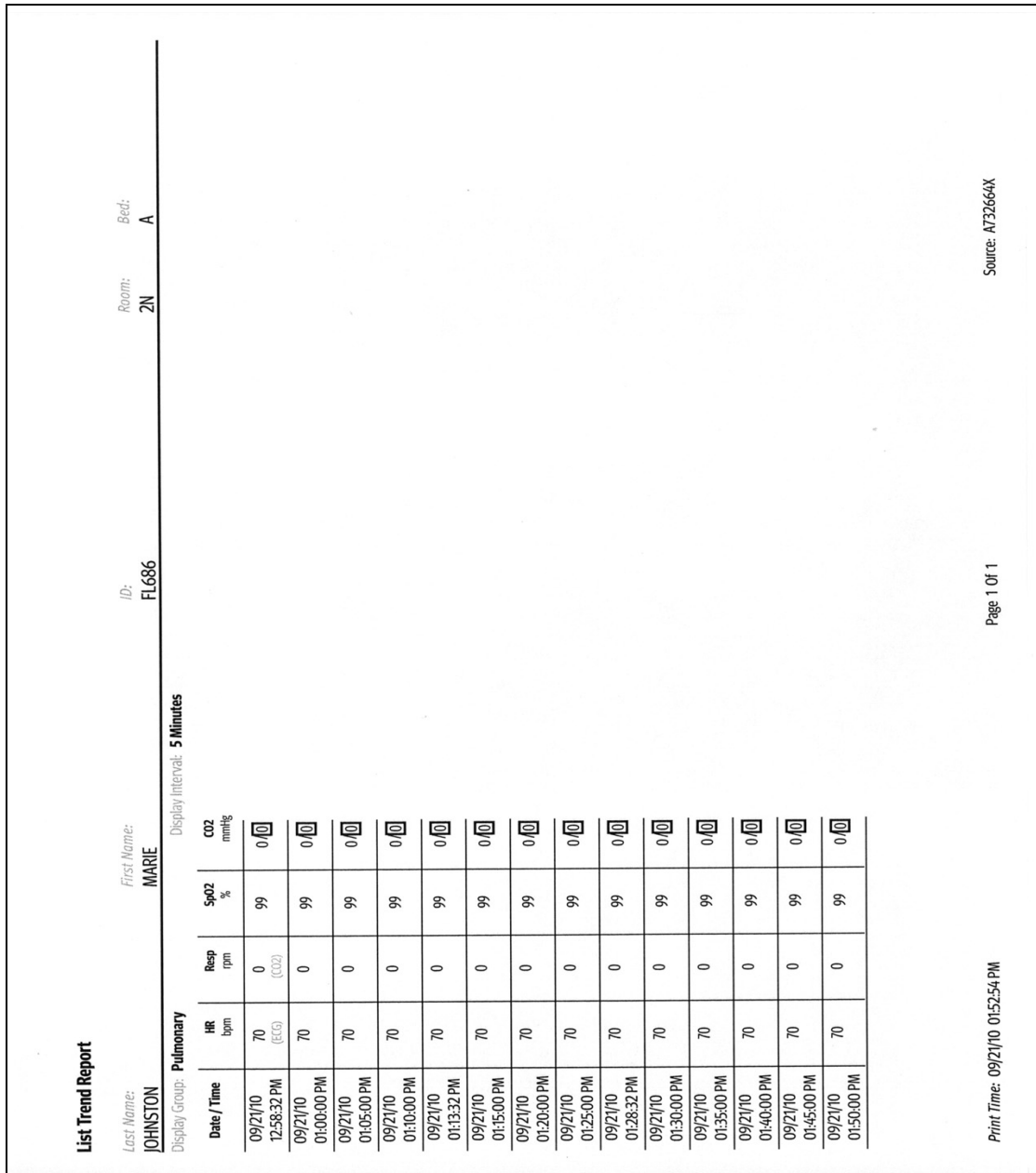

FIGURE 19-9 Example List Trend Report (Laser Printer Output)

19.5.3.1 Printing the List Trend Report

1. Select the **History** button from the Navigation Area.
2. Select the **List Trend** tab.
3. Navigate to the desired time.
4. Select the **Print** button.
5. Select a time interval.

NOTE: Refer to "Printing from the Historical Dialogs" on page 20-22 for additional information.

6. Select the **Accept** button.
The report prints.
7. Select the **Done** button.

19.5.4 Disclosure Overview Report

The Disclosure Overview Report (as shown in FIGURE 19-10) prints a maximum of 60 minutes of compressed ECG data on each page. Each waveform is one (1) minute in length. The heart rate prints the averaged heart rate for the last second of the strip at the end of the strip. This report includes a header, disclosure data, and a footer.

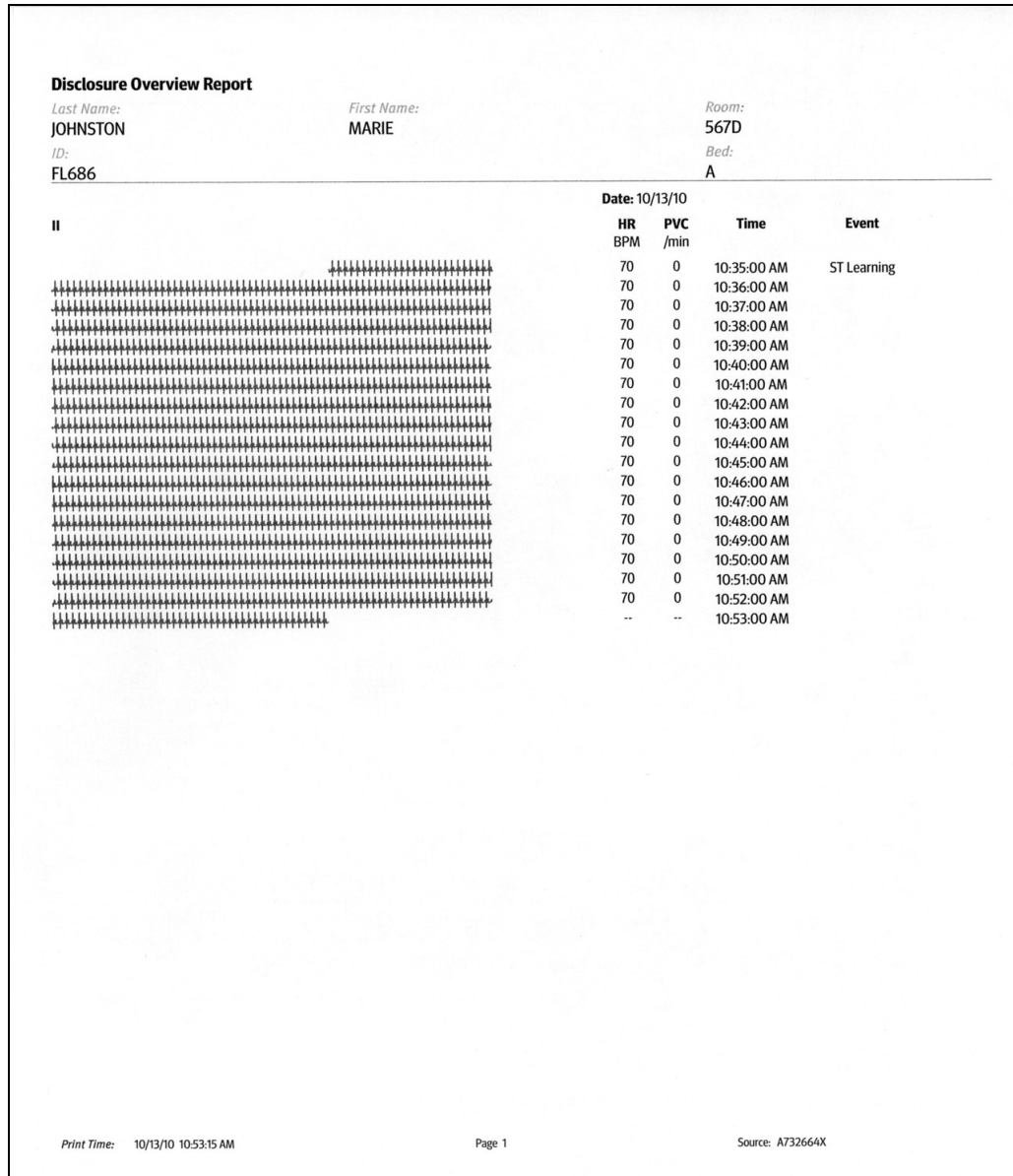

FIGURE 19-10 Example Disclosure Overview Report (Laser Printer Output)

19.5.4.1 Printing the Disclosure Overview Report

1. Select the **History** button from the Navigation Area.
2. Select the **Full Disclosure** tab.
3. Navigate to the desired time.
4. Select the **Print** button.
5. Select a time interval.

NOTE: Refer to "Printing from the Historical Dialogs" on page 20-22 for additional information.

6. Select the **Accept** button.
The report prints.
7. Select the **Done** button.

19.5.5 Disclosure Detail Report

The Disclosure Detail Report (as shown in FIGURE 19-11 and FIGURE 19-12) shows the detail for the specific area of disclosure data. A marker (shown as a triangle ▼) displays above the waveform grid indicating the date and time the data was recorded. This report includes a header, parameter detail, and a footer.

NOTE: This report may also be printed from the thermal printer. Refer to "Configuring the Print Destination" on page 19-5 for additional information.

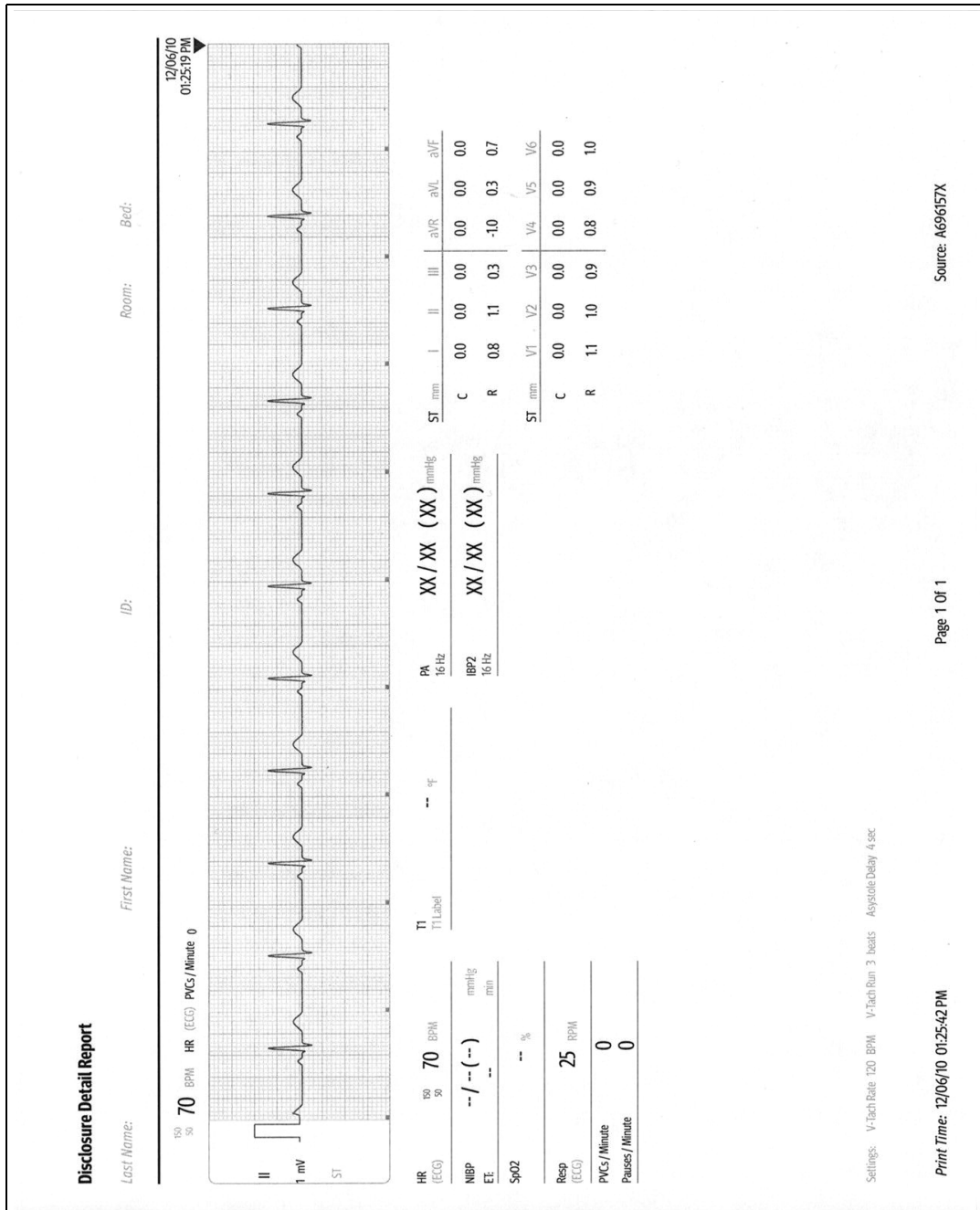

FIGURE 19-11 Example Disclosure Detail Report (Page 1) (Laser Printer Output)

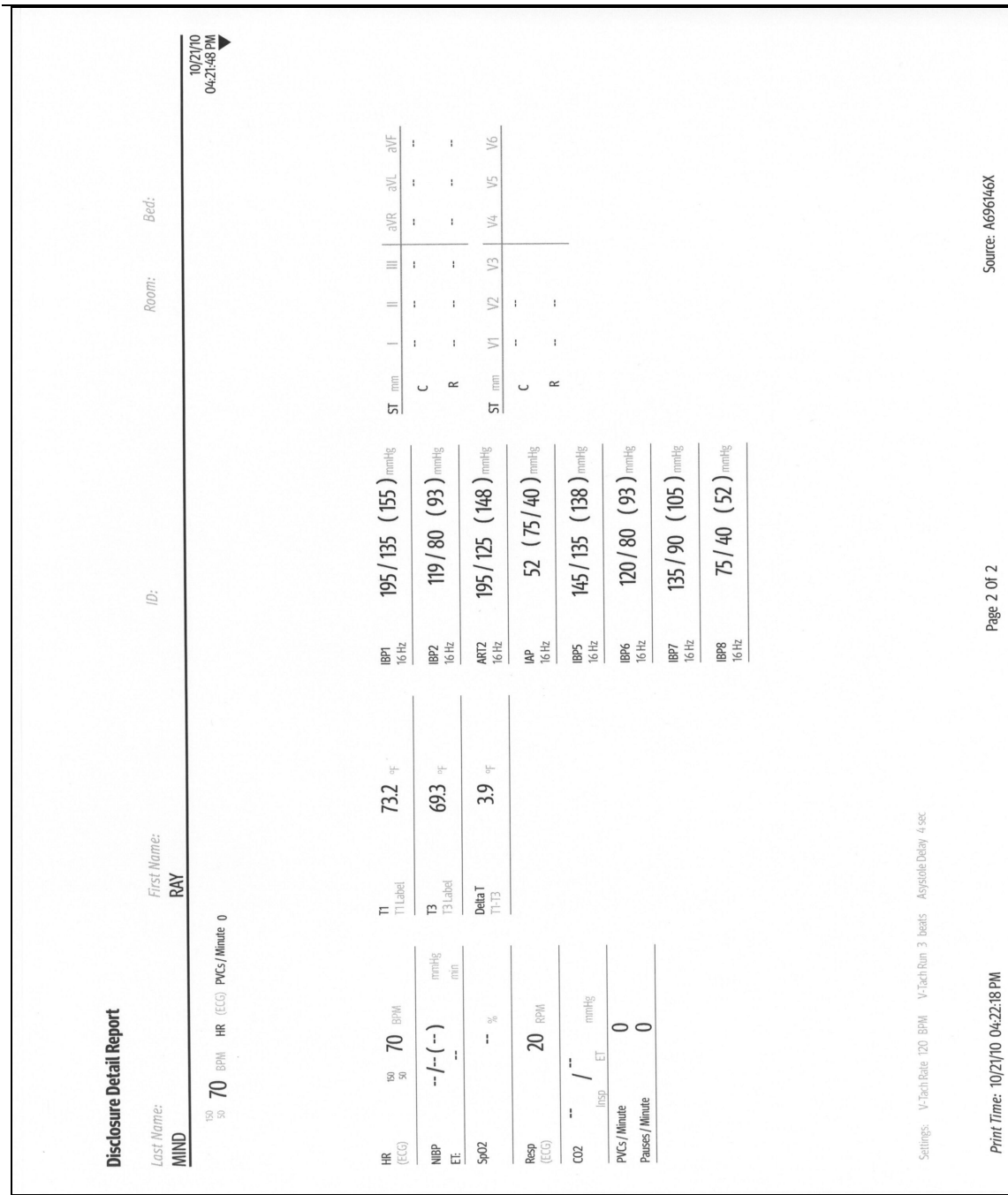

FIGURE 19-12 Example Disclosure Detail Report (Page 2) (Laser Printer Output)

19.5.5.1 Printing the Disclosure Detail Report

NOTE: This report contains waveforms. To configure which waveforms print in the report, refer to "Configuring the Waveforms to Print" on page 19-4.

1. Select the **History** button from the Navigation Area.
2. Select the **Full Disclosure** tab.
3. Navigate to the desired time.
4. Select the **Views** button.
5. Select **Detail**.
6. Select the **Print** button.
The report prints.
7. Select the **Done** button.

19.5.6 Event List Report

The Event List Report (as shown in FIGURE 19-13) shows a patient's historical physiological, system and technical alarm events for a 1, 2, 4, 8, 12 and 24 hour time period. This report includes a header, event records, and a footer.

NOTE: This report may also be printed from the thermal printer. Refer to "Configuring the Print Destination" on page 19-5 for additional information.

Event List Report																	
Last Name: JOHNSTON		First Name: MARIE		ID: FL686		Room: 2N		Bed: A									
Total Events: 1000				Displayed Events: 4				Event Filters: ET CO2 Low Alarm Violation									
Date / Time	Event	HR bpm	PVC /min	NIBP mmHg	SpO2 %	Resp rpm	CO2 mmHg	IBP1 mmHg	IBP2 mmHg	IBP3 mmHg	IBP4 mmHg	IBP5 mmHg	IBP6 mmHg	IBP7 mmHg	IBP8 mmHg	ART mmHg	ART2 mmHg
09/21/10 01:43:21 PM	ET CO2 Low Limit: 15	70 (ECG)	0	- / - (-)	99	0 (CO2)	0/0	- / - (-)	- / - (-)	120 / 80 (93)	75 / 40 (52)	XX / XX (XX)	XX / XX (XX)	XX / XX (XX)	XX / XX (XX)	119 / 80 (93)	124 / 85 (98)
09/21/10 01:23:09 PM	ET CO2 Low Limit: 15	70	0	- / - (-)	99	0	0/0	- / - (-)	- / - (-)	120 / 80 (93)	75 / 40 (52)	XX / XX (XX)	XX / XX (XX)	XX / XX (XX)	XX / XX (XX)	119 / 80 (93)	124 / 85 (98)
09/21/10 12:26:57 PM	ET CO2 Low Limit: 15	70	0	- / - (-)	99	0	0/0	- / - (-)	- / - (-)	120 / 80 (93)	75 / 40 (52)	XX / XX (XX)	XX / XX (XX)	XX / XX (XX)	XX / XX (XX)	119 / 79 (92)	124 / 84 (97)
09/21/10 12:16:02 PM	ET CO2 Low Limit: 15	70	0	- / - (-)	99	9	0/15	- / - (-)	- / - (-)	120 / 80 (93)	75 / 40 (52)	XX / XX (XX)	XX / XX (XX)	XX / XX (XX)	XX / XX (XX)	119 / 79 (92)	124 / 85 (98)

Source: A732664X

Page 1 Of 3

Print Time: 09/21/10 01:57:07 PM

FIGURE 19-13 Example Event List Report (only Page 1 shown) (Laser Printer Output)

19.5.6.1 Printing the Event List Report

1. Select the **History** button from the Navigation Area.
2. Select the **Events** tab.
3. Optional - create an event filter.

NOTE: Refer to "Applying/Removing an Events Filter" on page 20-8 for additional information.

4. Select the **Print** button.
5. Select a time interval.

NOTE: Refer to "Printing from the Historical Dialogs" on page 20-22 for additional information.

6. Select the **Accept** button.
The report prints.
7. Select the **Done** button.

19.5.7 Event Detail Report

The Event Detail Report (as shown in FIGURE 19-14 and FIGURE 19-15) shows all of a patient's historical digital data and 20 seconds of waveform data for a selected event. A marker (shown as a triangle ▼) displays above the waveform grid indicating the date and time the data was recorded. This report includes a header, digital data, waveform data, and a footer.

NOTE: This report may also be printed from the thermal printer. Refer to "Configuring the Print Destination" on page 19-5 for additional information.

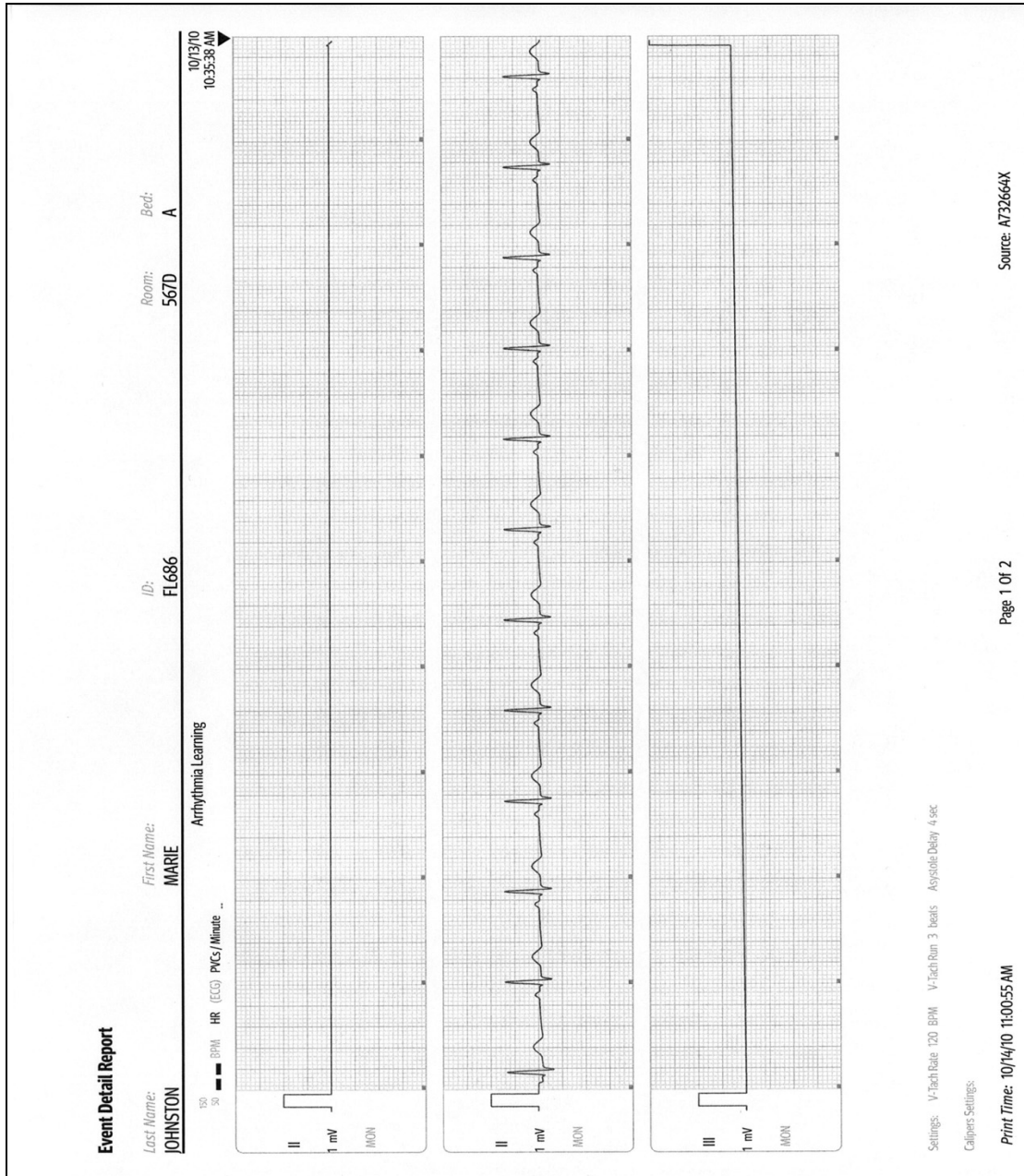

FIGURE 19-14 Example Event Detail Report (Page 1) (Laser Printer Output)

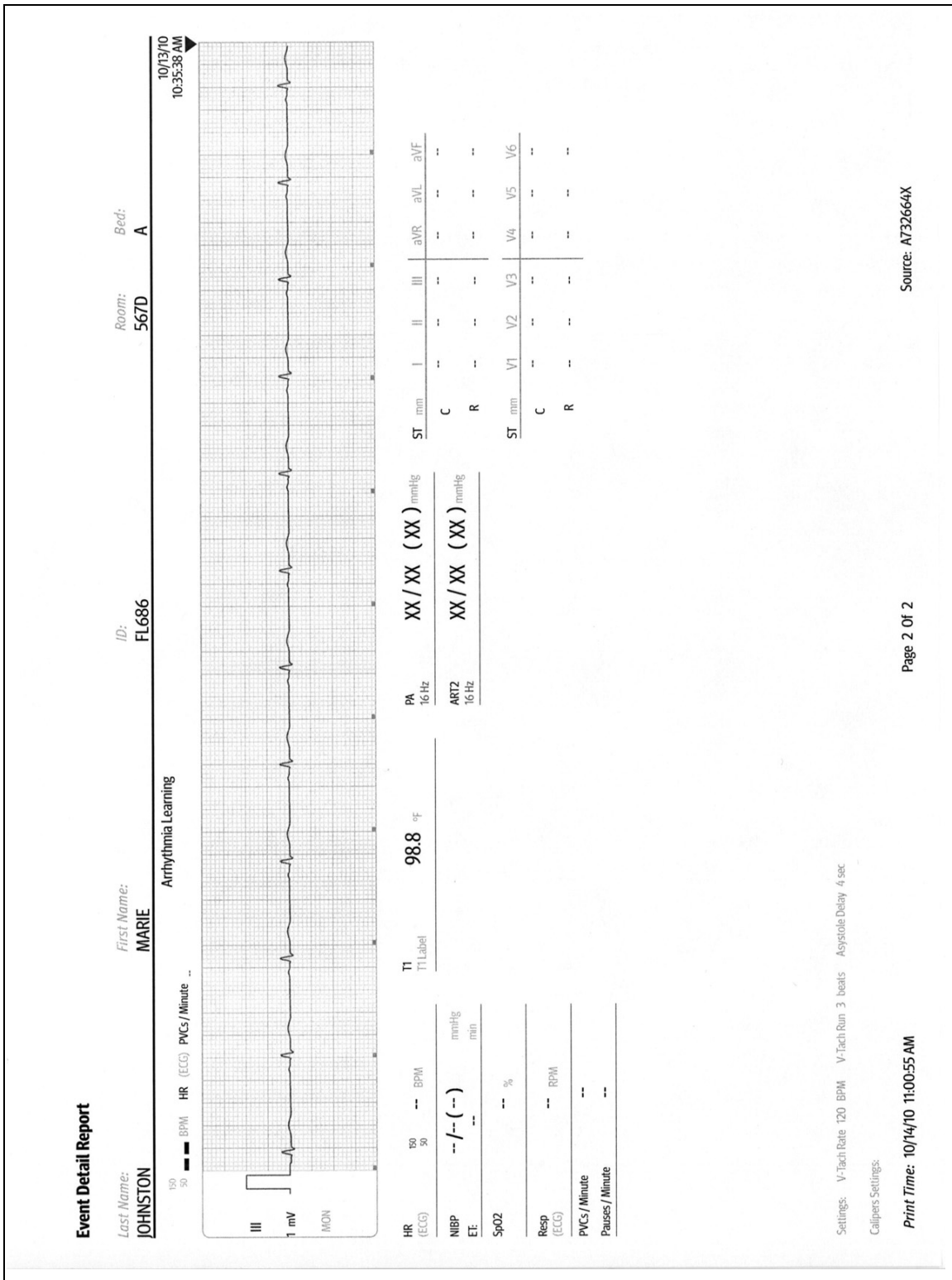

FIGURE 19-15 Example Event Detail Report (Page 2) (Laser Printer Output)

19.5.7.1 Printing the Event Detail Report

NOTE: This report contains waveforms. To configure which waveforms print in the report, refer to "Configuring the Waveforms to Print" on page 19-4.

1. Select the **History** button from the Navigation Area.
2. Select the **Events** tab.
3. Navigate to the desired event, then select it.
4. Select the **Views** button.
5. Select **Detail**.
6. Select the **Print** button.
The report print.
7. Select the **Done** button.

NOTE: Refer to "Events Tab" on page 20-7 for additional information.

19.5.8 Graphic Trend Report

The Graphic Trend Report (as shown in FIGURE 19-16 and FIGURE 19-17) displays the trends in a graphical format. This report includes a header, digital data, graphic data, and a footer.

NOTE: This report may also be printed from the thermal printer. Refer to "Configuring the Print Destination" on page 19-5 for additional information.

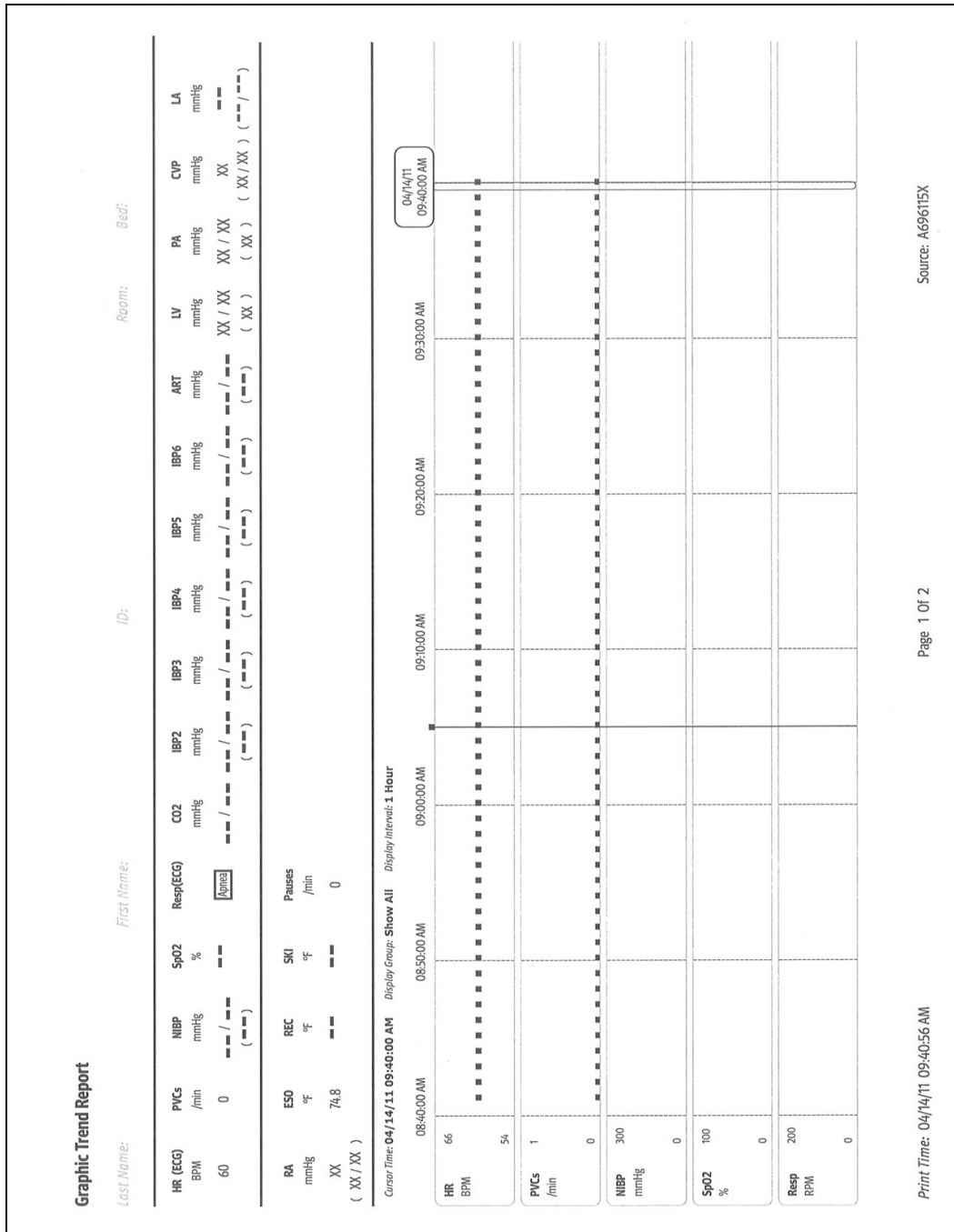

FIGURE 19-16 Example Graphic Trend Report (Page 1) (Laser Printer Output)

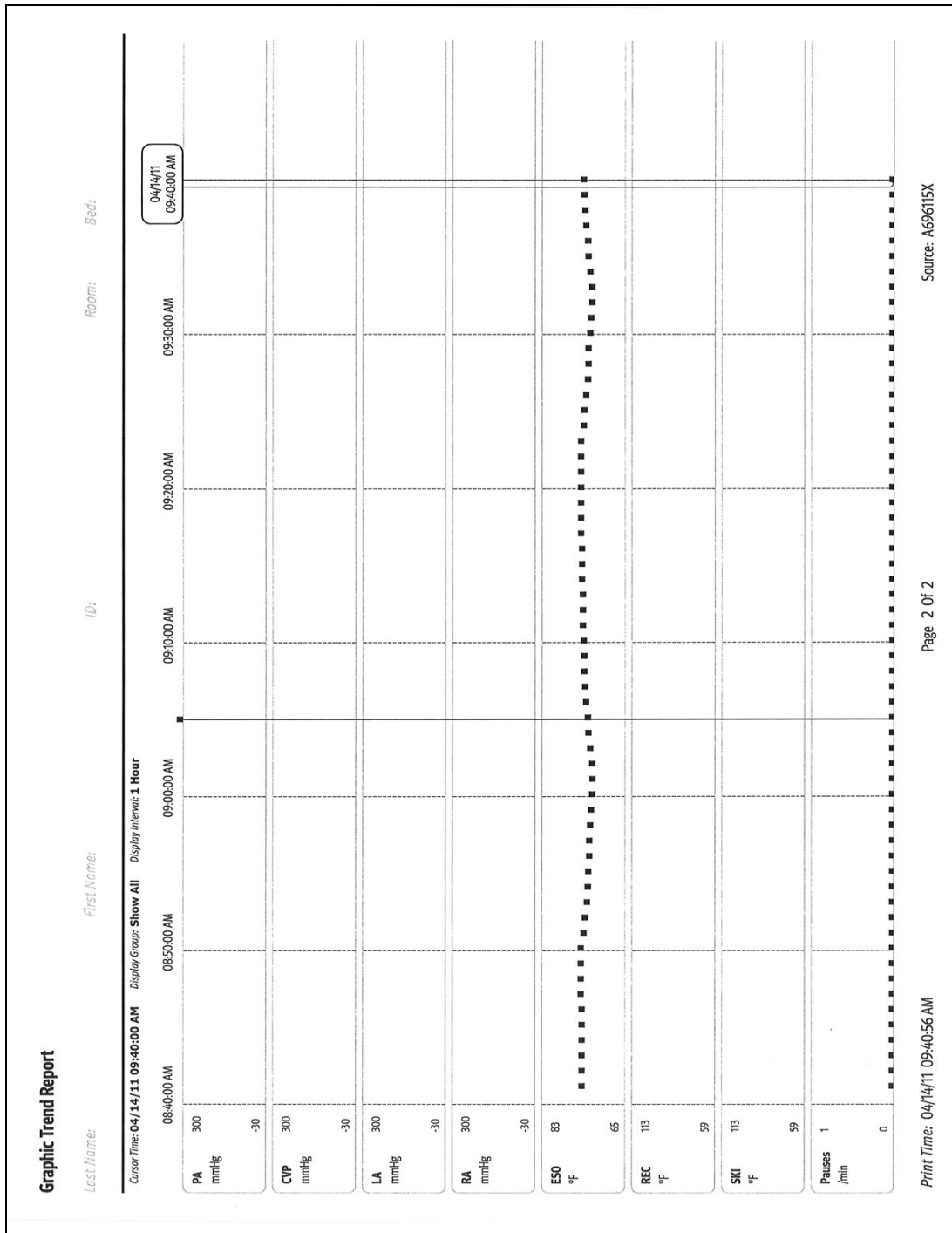

FIGURE 19-17 Example Graphic Trend Report (Page 2) (Laser Printer Output)

19.5.8.1 Printing the Graphic Trend Report

1. Select the **History** button from the Navigation Area.
2. Select the **Graphic Trends** tab.
3. Navigate to the desired time.
4. Select the **Print** button.
5. Select a time interval.

NOTE: Refer to "Printing from the Historical Dialogs" on page 20-22 for additional information.

6. Select the **Accept** button.
The report prints.
7. Select the **Done** button.

19.5.9 Print On Alarm Report

The Print On Alarm report automatically prints when the parameter's Print on Alarm alarm response setting is configured to On. A marker (shown as a triangle ▼) displays above the waveform grid indicating the date and time the data was recorded. This report includes a header, waveform data, and a footer.

NOTE: Refer to "Alarm Responses" on page 8-12 for additional information.

NOTE: This report may also be printed from the thermal printer. Refer to "Configuring the Print Destination" on page 19-5 for additional information.

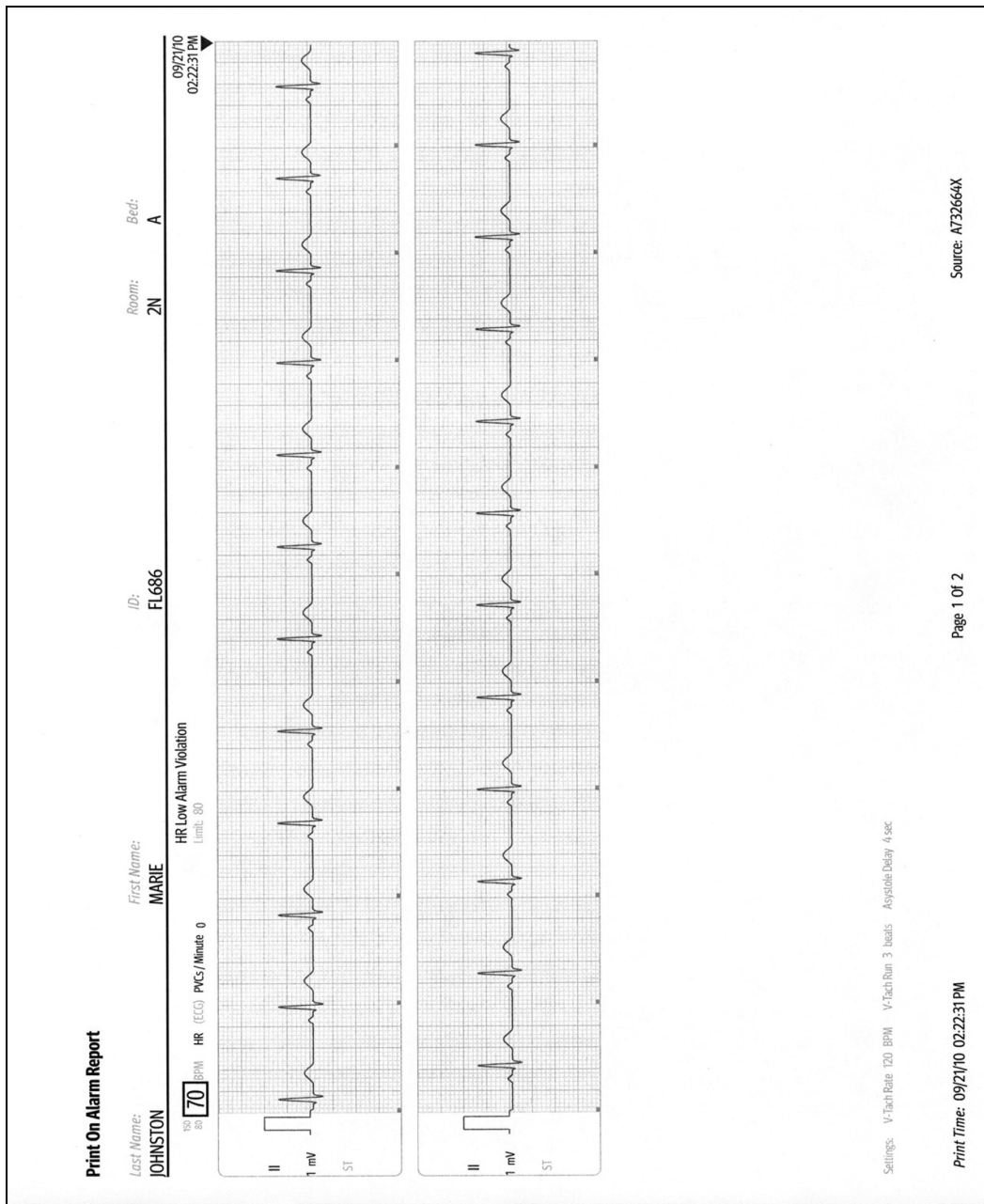

FIGURE 19-18 Example Print On Alarm Report (Laser Printer Output)

19.5.9.1 Printing the Print on Alarm Report

Refer to "Understanding Alarm Response Settings" on page 8-13 and "Configuring Alarm Response Settings" on page 8-13 for additional information.

19.5.10 ST Report

The ST Report (as shown in FIGURE 19-19 and FIGURE 19-20) includes current and reference digital values with the associated ST templates. This report includes a header, ST data, and a footer.

NOTE: This report may also be printed from the thermal printer. Refer to "Configuring the Print Destination" on page 19-5 for additional information.

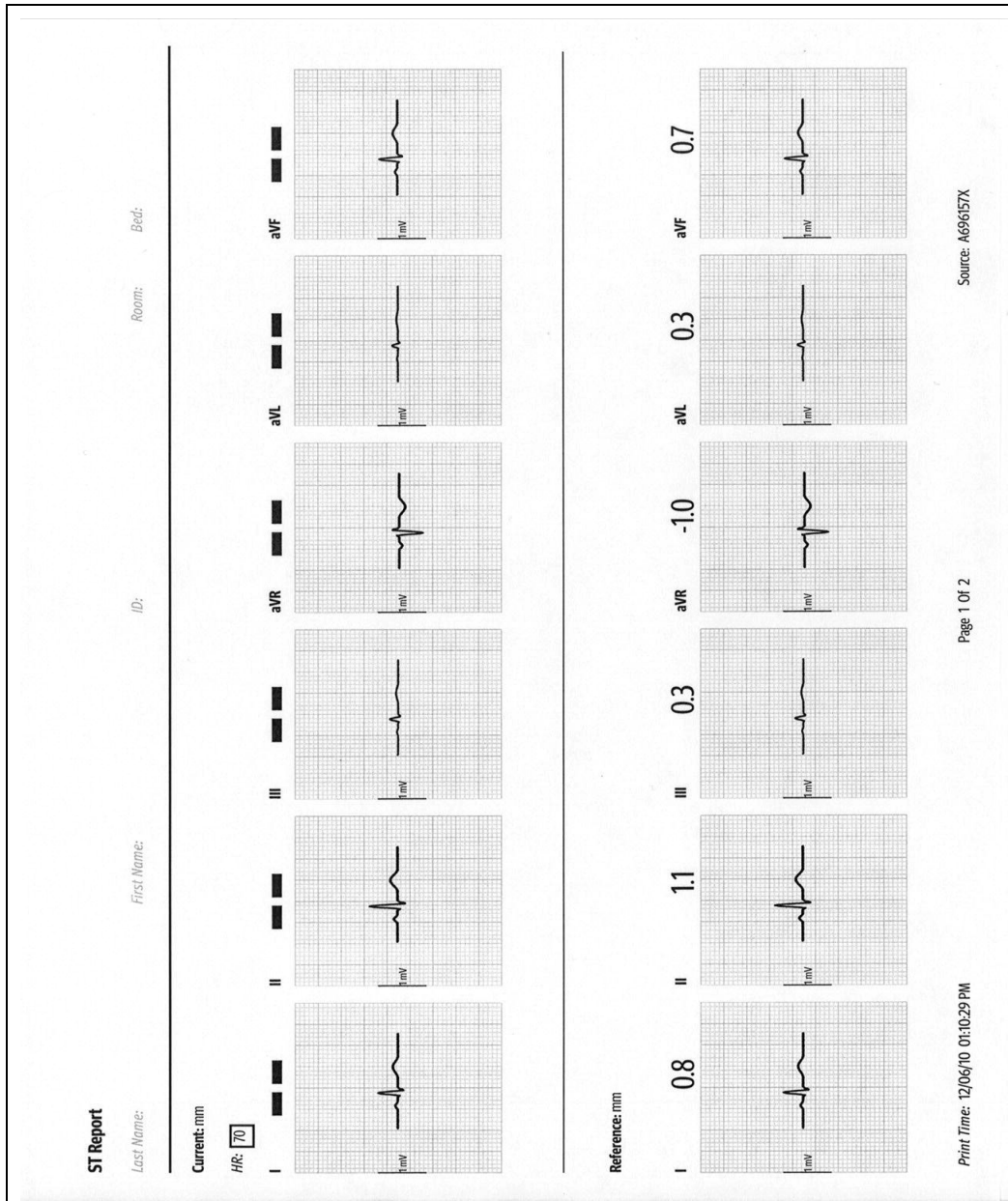

FIGURE 19-19 Example ST Report (Page 1) (Laser Printer Output)

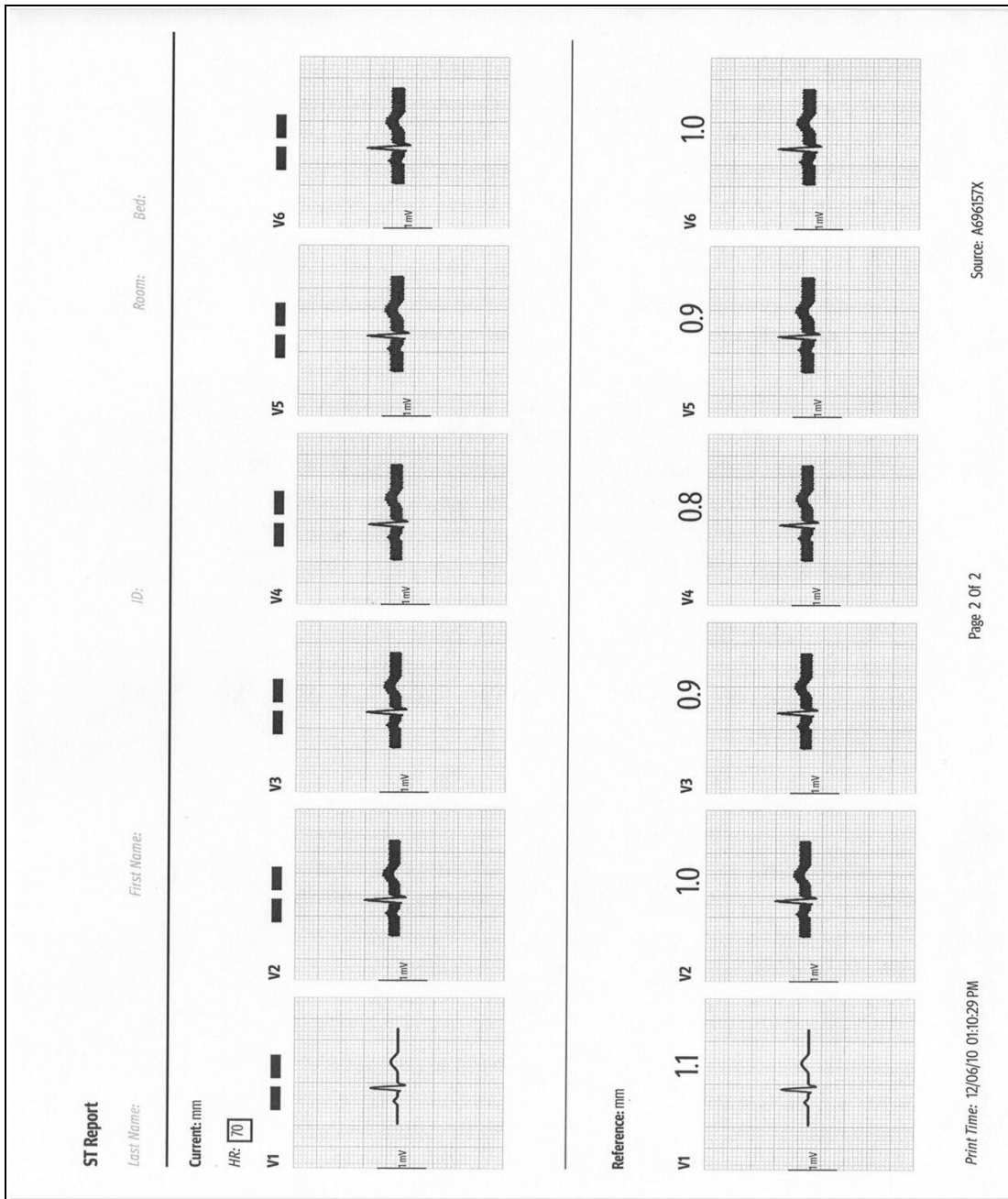

FIGURE 19-20 Example ST Report (Page 2) (Laser Printer Output)

19.5.10.1 Printing the ST Report

1. Select the ST tile.
2. Select the **Review** tab.
3. Select the **Print** button.
The report prints.

OR

1. Select the **Setup** tab from the Navigation Area.
2. Select the **Parameters** button.
3. Select the **ST** button.
4. Select the **Review** tab.
5. Select the **Print** button.
The report prints.

NOTE: Refer to "ST" on page 16-1 for additional information.

19.5.11 PAWP Report

The PAWP Report (as shown in FIGURE 19-21) includes all the waveforms contained in the PAWP dialog: ECG, ART2, PA, CO₂ plus all the other parameters being monitored during the PAWP measurement. This report includes a header, PAWP data, and a footer.

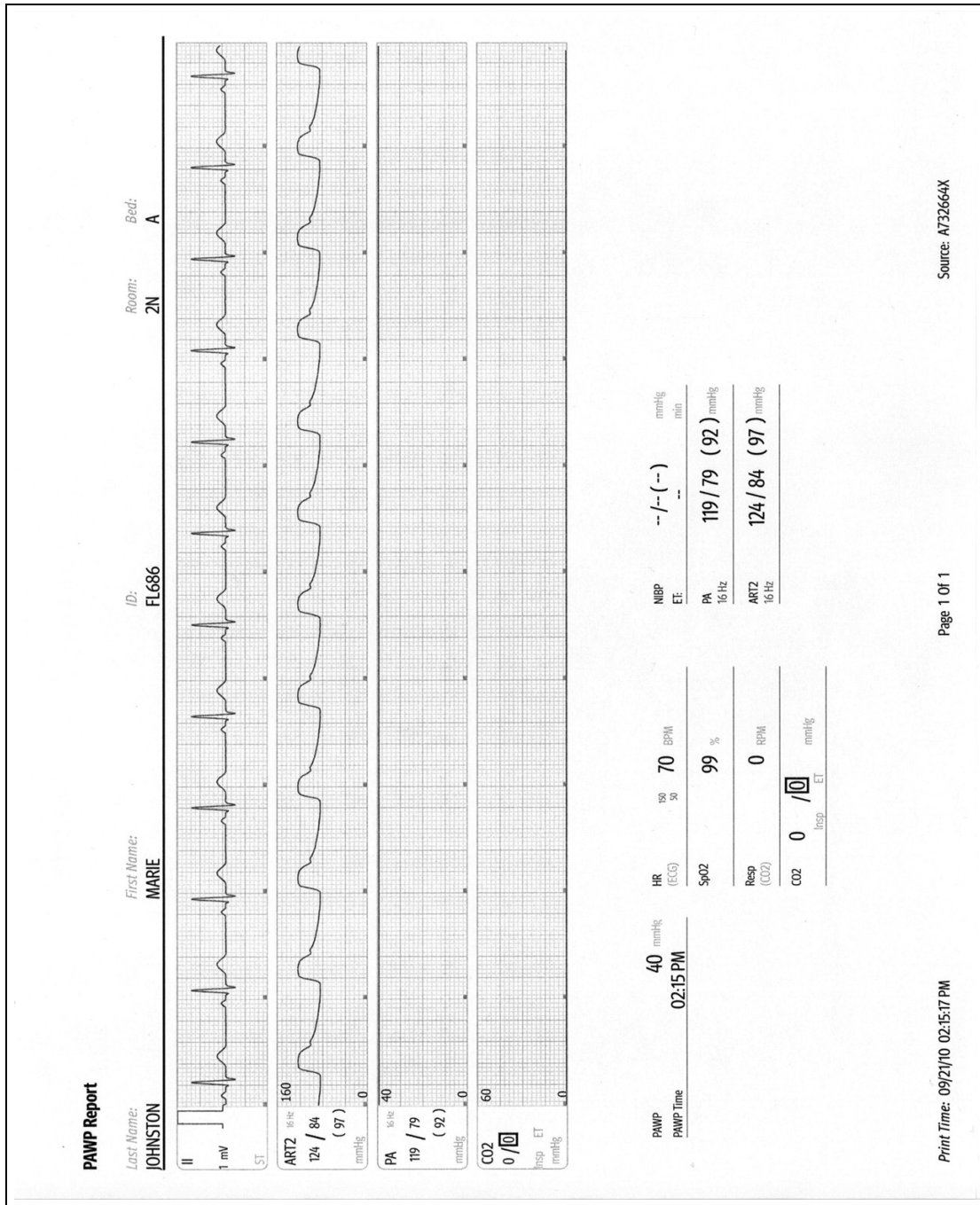

FIGURE 19-21 Example PAWP Report (Laser Printer Output)

19.5.11.1 Printing the PAWP Report

1. Select the PA tile.
2. Select the **PAWP** button.
3. Select the **Measure** button.
4. Select **Accept PAWP** button.
5. Select the **Print PAWP** button.
The report prints.

OR

1. Select the **Procedures** tab from the Navigation Area.
2. Select the **PAWP** button.
3. Select **Accept PAWP** button.
4. Select the **Print PAWP** button.
The report prints.
5. Select the **Done** button.

NOTE: Refer to "Pulmonary Artery Wedge Pressure (PAWP)" on page 11-17 for additional information.

19.5.12 Drug Calculations Report

The Drug Calculator Report (as shown in FIGURE 19-22) shows a detailed printout of specific drug information and drug infusion rates. This report includes a header, drug dosage and drug infusion rate information, and a footer.

NOTE: This report may also be printed from the thermal printer. Refer to "Configuring the Print Destination" on page 19-5 for additional information.

Drug Calculation Report			
<i>Last Name:</i>		<i>First Name:</i>	
<i>ID:</i>		<i>Room:</i>	
<i>Bed:</i>			
Drug Name :	Aminophylline/Theophylline	Date / Time :	04/14/11 10:31:10 AM
Drug Amount :	500.0 mg	Dose :	10.00 mg/kg/min
Drug Concentration :	1.0 mg/ml	Infusion Rate :	--
Solution Volume :	500 ml	Weight:	440.9 lbs = 200.0 kg

Dose mg/kg/min	Infusion Rate ml/hr	Dose mg/kg/min	Infusion Rate ml/hr
1.00	--	16.00	--
2.00	--	17.00	--
3.00	--	18.00	--
4.00	--	19.00	--
5.00	--	20.00	--
6.00	--	21.00	--
7.00	--	22.00	--
8.00	--	23.00	--
9.00	--	24.00	--
10.00	--	25.00	--
11.00	--	26.00	--
12.00	--	27.00	--
13.00	--	28.00	--
14.00	--	29.00	--
15.00	--	30.00	--

<i>Print Time:</i> 04/14/11 11:04:46 AM	<i>Page</i> 1 Of 1	<i>Source:</i> A69615X
---	--------------------	------------------------

FIGURE 19-22 Example Drug Calculation Report (Laser Printer Output)

19.5.12.1 Printing the Drug Calculations Report

1. Select the **Tools** tab from the Navigation Area.
2. Select the **Calculators** button.
3. Select the **Drug** button.
4. Select a drug from the **Previous Calculations** list at the top of the dialog box.
5. Select the **Titration Table** tab.
6. Select the **Print** button.
The report prints.

NOTE: **To enable the Print button, there must be at least one calculation in the table.**

7. Select the **Done** button.

NOTE: **Refer to "Drug Calculations" on page 21-7 for additional information.**

19.5.13 Hemodynamic Calculation Report

The Hemodynamic Calculations Report (as shown in FIGURE 19-23) prints the set of values used to determine the hemodynamic status of the patient. The report includes header information, hemodynamic calculations, and a footer.

NOTE: This report may also be printed from the thermal printer. Refer to "Configuring the Print Destination" on page 19-5 for additional information.

Hemodynamic Calculation Report				
<i>Last Name:</i>		<i>First Name:</i>		<i>Room:</i>
JOHNSTON		MARIE		2N
<i>ID:</i>				<i>Bed:</i>
FL686				A
<i>Date:</i>	09/21/10	09/21/10	09/21/10	
<i>Time:</i>	01:58:41 PM	01:59:46 PM	02:00:06 PM	
CO	--	15.0 *	15.0 *	L/min
CO Time	--	01:59 PM	01:59 PM	
CI	--	7.1 *	7.1 *	L/min/m ²
HR	70	70	70	bpm
MAP	92	92	92	mmHg
MAP Source	ART	ART	ART	
ART Diastolic	79	79	79	mmHg
Mean PA	--	200 *	200 *	mmHg
PAWP	--	15 *	15 *	mmHg
PAWP Time	--	01:59 PM	01:59 PM	
CVP	--	36 *	36 *	mmHg
RA	--	--	--	mmHg
BSA	2.1	2.1	2.1	m ²
SV	--	214 *	214 *	mL
SVI	--	101.9 *	101.9 *	mL/m ²
SVR	--	299 *	299 *	dyne-sec/cm5
SVRI	--	628 *	628 *	dyne-sec/cm5/m ²
PVR	--	986 *	986 *	dyne-sec/cm5
PVRI	--	--	--	dyne-sec/cm5/m ²
LCW	--	18.8 *	18.8 *	kg-m
LCWI	--	9.0 *	9.0 *	kg-m/m ²
RCW	--	40.8 *	40.8 *	kg-m
RCWI	--	19.4 *	19.4 *	kg-m/m ²
LVSW	--	224 *	224 *	g-m
LVSWI	--	107 *	107 *	g-m/m ²
RVSW	--	--	--	g-m
RVSWI	--	--	--	g-m/m ²
CoPP	--	64 *	64 *	mmHg
EF	--	56 *	56 *	%
EDV	--	382 *	382 *	mL
EDVI	--	--	--	mL/m ²
ESV	--	168 *	168 *	mL
ESVI	--	80.0 *	80.0 *	mL/m ²

Print Time: 09/21/10 02:00:09 PM Page 1 Of 1 Source: A732664X

FIGURE 19-23 Example Hemodynamic Calculations Report (Laser Printer Output)

19.5.13.1 Printing the Hemodynamic Calculation Report

1. Select the **Tools** tab from the Navigation Area.
2. Select the **Calculators** button.
3. Select the **Hemo Calculations** button.
4. Select the **Print** button.
The report prints.

NOTE: **To enable the Print button, there must be at least one calculation in the log.**

5. Select the **Done** button.
6. Select the **Done** button.

19.5.14 Quick Trend Report

The Quick Trend Report (as shown in FIGURE 19-24) shows a detailed printout of the Quick Trends list in the History tab. This report includes a header, quick trend data (HR, SpO₂, NIBP), and a footer.

NOTE: This report may also be printed from the thermal printer. Refer to "Configuring the Print Destination" on page 19-5 for additional information.

Quick Trend Report		Last Name: JOHNSTON		First Name: MARIE		ID: FL686		Room: 2N		Bed: A	
Date / Time	HR bpm	SpO ₂ %	NIBP mmHg								
09/21/10 12:12:28 PM	70 (ECG)	99	121 / 82 (97)								
09/21/10 12:28:34 PM	70	99	122 / 81 (96)								
09/21/10 12:43:32 PM	70	99	120 / 83 (98)								
09/21/10 12:58:32 PM	70	99	120 / 81 (96)								
09/21/10 01:13:32 PM	70	99	121 / 81 (95)								
09/21/10 01:28:32 PM	70	99	120 / 83 (97)								

Source: A732664X

Page 1 Of 1

Print Time: 09/21/10 01:54:44 PM

FIGURE 19-24 Example Quick Trend Report (Laser Printer Output)

19.5.14.1 Printing the Quick Trend Report

1. Select the **History** button from the Navigation Area.
By default, the **Quick Trends** tab is selected.
2. Select the **Print** button.
The report prints.

19.5.15 System Settings Report

The System Settings Report (as shown in FIGURE 19-25 and FIGURE 19-26) prints every parameter by patient size. In addition, it prints the unit of measure, high and low alarm limits, alarm priority, arrhythmia settings, and the alarm response settings. The report includes a header, system settings information, and a footer.

System Settings Report							
<i>Department:</i>		<i>Room: 2N</i>			<i>Bed: A</i>		
Parameter	Units	Adult Alarm Settings					
		High Limit	Low Limit	Priority	Print On Alarm	SaveToEvent	Nurse Call
HR	BPM	150	50	Medium	Off	On	Off
ST Single	mm	Off	Off	Medium	Off	On	Off
ST Dual	mm	Off	Off	Medium	Off	On	Off
SpO2	%	101	88	Medium	Off	On	Off
Resp	RPM	Off	Off	Low	Off	On	Off
Apnea				High	Off	On	Off
NIBP Sys	mmHg	Off	Off	Low	Off	On	Off
NIBP Dia	mmHg	Off	Off	Low	Off	On	Off
NIBP Mean	mmHg	Off	Off	Low	Off	On	Off
IBP1 Sys	mmHg	Off	Off	Low	Off	On	Off
IBP1 Dia	mmHg	Off	Off	Low	Off	On	Off
IBP1 Mean	mmHg	Off	Off	Low	Off	On	Off
IBP2 Sys	mmHg	Off	Off	Low	Off	On	Off
IBP2 Dia	mmHg	Off	Off	Low	Off	On	Off
IBP2 Mean	mmHg	Off	Off	Low	Off	On	Off
IBP3 Sys	mmHg	Off	Off	Low	Off	On	Off
IBP3 Dia	mmHg	Off	Off	Low	Off	On	Off
IBP3 Mean	mmHg	Off	Off	Low	Off	On	Off
IBP4 Sys	mmHg	Off	Off	Low	Off	On	Off
IBP4 Dia	mmHg	Off	Off	Low	Off	On	Off
IBP4 Mean	mmHg	Off	Off	Low	Off	On	Off
IBP5 Sys	mmHg	Off	Off	Low	Off	On	Off
IBP5 Dia	mmHg	Off	Off	Low	Off	On	Off
IBP5 Mean	mmHg	Off	Off	Low	Off	On	Off
IBP6 Sys	mmHg	Off	Off	Low	Off	On	Off
IBP6 Dia	mmHg	Off	Off	Low	Off	On	Off
IBP6 Mean	mmHg	Off	Off	Low	Off	On	Off
IBP7 Sys	mmHg	Off	Off	Low	Off	On	Off
IBP7 Dia	mmHg	Off	Off	Low	Off	On	Off
IBP7 Mean	mmHg	Off	Off	Low	Off	On	Off
IBP8 Sys	mmHg	Off	Off	Low	Off	On	Off
IBP8 Dia	mmHg	Off	Off	Low	Off	On	Off
IBP8 Mean	mmHg	Off	Off	Low	Off	On	Off
ART Sys	mmHg	Off	Off	Low	Off	On	Off
ART Dia	mmHg	Off	Off	Low	Off	On	Off
ART Mean	mmHg	Off	Off	Low	Off	On	Off

Print Time: 09/21/10 02:21:51 PM *Page 1 Of 19* *Source: A732664X*

FIGURE 19-25 Example System Settings Report (Page 1) (Laser Printer Output)

System Settings Report							
<i>Department:</i>		<i>Room: 2N</i>			<i>Bed: A</i>		
Neonate Alarm Settings							
Parameter	Units	High Limit	Low Limit	Priority	Print On Alarm	SaveToEvent	Nurse Call
LA Sys	mmHg	Off	Off	Low	Off	On	Off
LA Dia	mmHg	Off	Off	Low	Off	On	Off
LA Mean	mmHg	Off	Off	Low	Off	On	Off
RA Sys	mmHg	Off	Off	Low	Off	On	Off
RA Dia	mmHg	Off	Off	Low	Off	On	Off
RA Mean	mmHg	Off	Off	Low	Off	On	Off
CO2 ET	%	10.0	2.0	Medium	Off	On	Off
CO2 Insp	%	1.0		Medium	Off	On	Off
CO2 ET	mmHg	60	15	Medium	Off	On	Off
CO2 Insp	mmHg	10		Medium	Off	On	Off
CO2 ET	kPa	10.0	2.0	Medium	Off	On	Off
CO2 Insp	kPa	1.0		Medium	Off	On	Off
Temp1	°C	Off	Off	Low	Off	On	Off
Temp1	°F	Off	Off	Low	Off	On	Off
Temp2	°C	Off	Off	Low	Off	On	Off
Temp2	°F	Off	Off	Low	Off	On	Off
Temp3	°C	Off	Off	Low	Off	On	Off
Temp3	°F	Off	Off	Low	Off	On	Off
T Blood	°C	Off	Off	Low	Off	On	Off
T Blood	°F	Off	Off	Low	Off	On	Off
ΔT	°C	Off	Off	Low	Off	On	Off
ΔT	°F	Off	Off	Low	Off	On	Off
Adult Arrhythmia Alarm Settings							
Arrhythmia	On/Off	Priority	Audio Response	Print On Alarm	SaveToEvent	Nurse Call	
Asystole	On	High		Off	On	Off	
Ventricular Tachycardia	On	High		Off	On	Off	
Ventricular Fibrillation	On	High		Off	On	Off	
Bradycardia	Off	High	On	Off	On	Off	
R-On-T PVC	Off	Medium	On	Off	On	Off	
Pause	Off	Medium	On	Off	On	Off	
Pauses / Minute	Off	Medium	On	Off	On	Off	
Bigeminy	Off	Low	On	Off	On	Off	

Print Time: 09/21/10 02:21:51 PM

Page 7 Of 19

Source: A732664X

FIGURE 19-26 Example System Settings Report (Page 2) (Laser Printer Output)

19.5.15.1 Printing the System Settings Report

1. Select the **Setup** tab from the Navigation Area.
2. Select the **System** button.
3. Enter the password.
The System dialog opens.
4. Select the **System** tab.
5. Select the **Print System Settings** button.
The report prints.
6. Select the **Accept** button.

19.6 Printing Troubleshooting

MESSAGE/PROBLEM	REASON	SOLUTION
Printer overheats	Printer has not had ample time to recover between print requests.	Do not use printer again until temperature reduces.
Printer paper jam	Paper is stuck in printer.	Try to clear jam. If unable to clear jam, contact service personnel.

History Dialogs

Introduction	20-2
Trends.....	20-2
Events Tab.....	20-7
Full Disclosure	20-13
History Dialog Common Functions.....	20-16
Historical Events	20-25
Troubleshooting	20-30

20.1 Introduction

The History dialog provides access to a patient's historical physiological data. The **History** dialog (as shown in FIGURE 20-1) contains a **Quick Trends** tab, **List Trends** tab, **Graphic Trends** tab, **Events**, and **Full Disclosure** tab. A description of each tab follows.

Patient Sizes

Intended patient types: Adult, Pediatric, Neonate.

20.2 Trends

The History dialog contains Quick Trends, List Trends, and Graphic Trends.

20.2.1 Navigating to the Quick Trends Tab

- Select the **History** button from the Navigation Area.
The History dialog displays (as shown in FIGURE 20-1) with the Quick Trends tab selected.

Date/Time	09/21/10 12:12 PM	09/21/10 12:28 PM	09/21/10 12:43 PM	09/21/10 12:58 PM	09/21/10 01:13 PM	09/21/10 01:28 PM	09/23/10 10:36 AM	09/23/10 10:42 AM	09/23/10 10:43 AM	09/23/10 10:44 AM	09/23/10 10:45 AM	09/23/10 10:46 AM
HR bpm	70	70	70	70	70	70	70	70	70	70	70	70
SpO2 %	99	99	99	99	99	99	99	99	99	99	99	99
NIBP mmHg	121/82 (97)	122/81 (96)	120/83 (98)	120/81 (96)	121/81 (95)	120/83 (97)	120/81 (96)	120/81 (97)	120/82 (96)	120/80 (95)	117/79 (94)	118/77 (96)

FIGURE 20-1 Example History Dialog (Quick Trends Tab)

20.2.2 About Quick Trends

The Quick Trends tab allows the user to view an abbreviated tabular listing of HR, SpO₂ and NIBP data only and includes the date and time the trend recorded. Data will not collect in the Quick Trends list until an NIBP measurement is taken. Each time an NIBP measurement is taken, the list updates. The list can only display a maximum of nine (9) records at one time. Once the tenth NIBP measurement is taken, the first measurement is removed from the Quick Trends list but **not** from the List Trends list.

20.2.3 List Trends

The List Trends display allows the user to view a tabular list of stored patient vital signs. Trend data automatically displays in one minute intervals unless an alternate Trend Display interval is selected.

NOTE: Refer to "Configuring a Display Interval" on page 20-16 for additional information.

Selecting the **List Trends** tab before the first measurement is taken will display an empty list. An NIBP, CO/CI, or PAWP measurement must be taken before the list will populate. All previously collected parameter data displays, even if the parameter is not currently being monitored.

20.2.4 Navigating to the List Trends Tab

1. Select the **History** button from the Navigation Area.
The History dialog displays (as shown in FIGURE 20-1).
2. Select the **List Trends** tab (as shown in FIGURE 20-2).

NOTE: The Display Interval in FIGURE 20-2 is configured for one (1) minute intervals. Refer to "Configuring a Display Interval" on page 20-16 for more information.

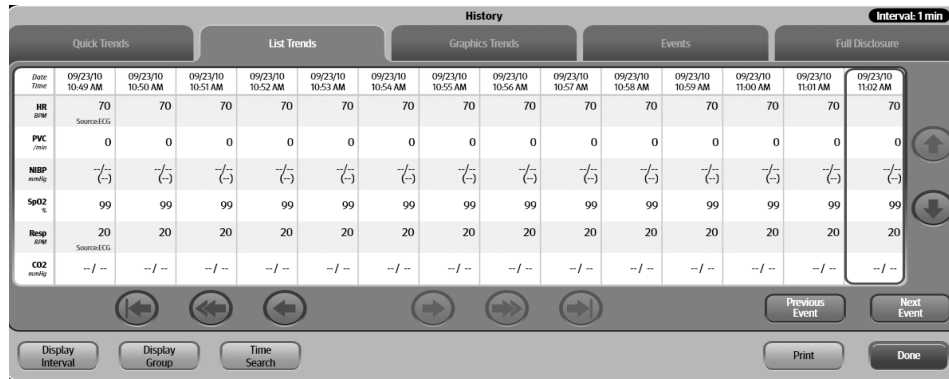

FIGURE 20-2 Example History Dialog (List Trends Tab)

20.2.5 About the List Trends Tab

- List Trends displays the time and date on the horizontal axis and it is always visible.
- List Trends displays the parameter data on the vertical axis and it is always visible.
- List Trends always displays the Heart Rate (HR) parameter in the top row.
- List Trends displays the trend records in descending order, beginning with the most recent on the right side of the grid.
- List Trends displays any currently monitored parameter or previously monitored parameter that is configured to display.

20.2.6 Navigating in the List Trends Tab

The dialog navigation buttons are described in TABLE 20-1.

NOTE: When a navigation button becomes disabled, this indicates that there is no more data available or the end of the data range was reached.

TABLE 20-1









BUTTON	FUNCTION
	Moves the cursor to the oldest record from its current position.
	Moves the cursor one page back from its current position.

TABLE 20-1

BUTTON	FUNCTION
	Moves the cursor one record back from its current position.
	Moves the cursor one record forward from its current position.
	Moves the cursor one page forward from its current position.
	Moves the cursor to the newest record from its current position.
Previous Event	Moves the cursor to the previous event from its current position.
Next Event	Moves the cursor to the next event from its current position.
	Moves the cursor up one parameter from its current position.
	Moves the cursor down one parameter from its current position.

20.2.7 Configuring a List Trends Display Interval

Refer to "Configuring a Display Interval" on page 20-16 for additional information.

20.2.8 Configuring a List Trends Display Group

Refer to "Configuring a Display Group" on page 20-17 for additional information.

20.2.9 Configuring a List Trends Time Search

Refer to "Configuring a Time Search" on page 20-19 for additional information.

20.2.10 Printing from the List Trends Tab

Refer to "Printing from the Historical Dialogs" on page 20-22 for additional information.

20.2.11 Graphic Trends

The **Graphic Trend** display allows the user to view a graphic summary of stored patient vital signs.

20.2.12 Navigating to the Graphic Trends Tab

1. Select the **History** button from the Navigation Area.
2. Select the **Graphic Trends** tab (as shown in FIGURE 20-3).

NOTE: The display interval in FIGURE 20-3 is configured for one (1) hour. Refer to "Configuring a Display Interval" on page 20-16 for more information.

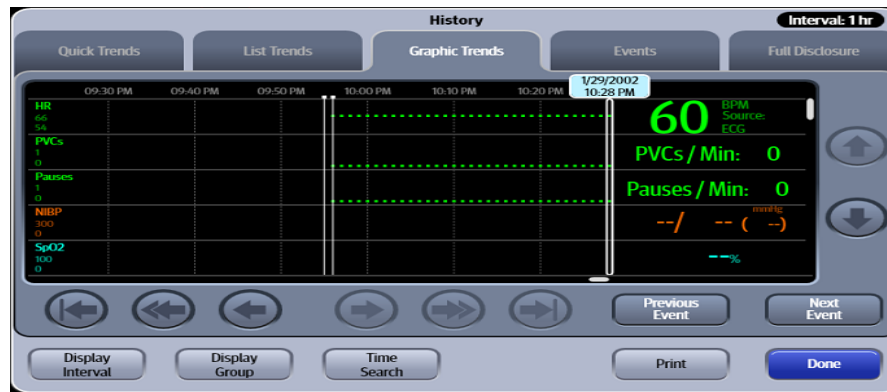

FIGURE 20-3 Example History Dialog (Graphic Trends Tab)

20.2.13 About the Graphic Trends Tab

- The Graphic Trends area displays a trend digital tile adjacent to each trend graph.
- The Graphic Trends area always displays the heart rate (HR) as the first trend graph and it is fixed in the top row position.
- The Graphic Trends area displays the trend data in the time range specified in the Display Interval.
- The Graphic Trends provides a trend cursor which moves around the historical data based on which navigation button is selected.
- The Graphic Trends area displays the date and time of the trend cursor.
- The Graphic Trends area displays a blank tile when no trend data is available for the configured parameter.
- The Graphic Trends horizontal scale is automatically scaled to present the entire waveform at the maximum height.
- The Graphic Trends area displays a vertical event marker line for each historical event. The event marker line extends from the top of the trend graph to the bottom.
 - The event marker contains the event date and time and the event message.
 - The event marker line displays in the color corresponding to the priority of the event.
 - The event marker lines displays the event with the highest priority when multiple events occur at the same time.

20.2.14 Viewing Event Detail from Graphic Trends

1. Select the **History** button from the Navigation Area.
2. Select the **Graphic Trends** tab.
3. Position the trend cursor on an event by selecting the **Previous Event** or **Next Event** buttons. The cursor advances to the next event. Beside the cursor is an event message tag. For example, **Arrhythmia Relearn**.
4. Select the event message bubble.
The event opens in the **Events** tab where the event details display.

NOTE: Refer to "Events Tab" on page 20-7 for additional information.

20.2.15 Navigating in the Graphic Trends Tab

The navigation buttons in the Graphic Trends tab are the same as described in the List Trends tab. Refer to "Navigating in the List Trends Tab" on page 20-3 for additional information.

20.2.16 Configuring a Graphic Trends Display Interval

Refer to "Configuring a Display Interval" on page 20-16 for additional information.

20.2.17 Configuring a Graphic Trends Display Group

Refer to "Configuring a Display Group" on page 20-17 for additional information.

20.2.18 Configuring a Graphic Trends Time Search

Refer to "Configuring a Time Search" on page 20-19 for additional information.

20.2.19 Printing from Graphic Trends

Refer to "Printing from the Historical Dialogs" on page 20-22 for additional information.

20.3 Events Tab

The Events tab lists all the patient's events. View events in a list format or a detail format. Both views are outlined in this section. Events can be physiological indicating that a patient's physiological alarm thresholds have been violated or technical indicating that a specific technical issue has occurred. Some events are saved to the events database.

NOTE: For a list of the specific events saved to the events database, refer to "Historical Events" on page 20-25.

20.3.1 Navigating to the Events Tab

1. Select the **History** button from the Navigation Area.
2. Select the **Event** tab.
The Events - List view displays (as shown in FIGURE 20-4).

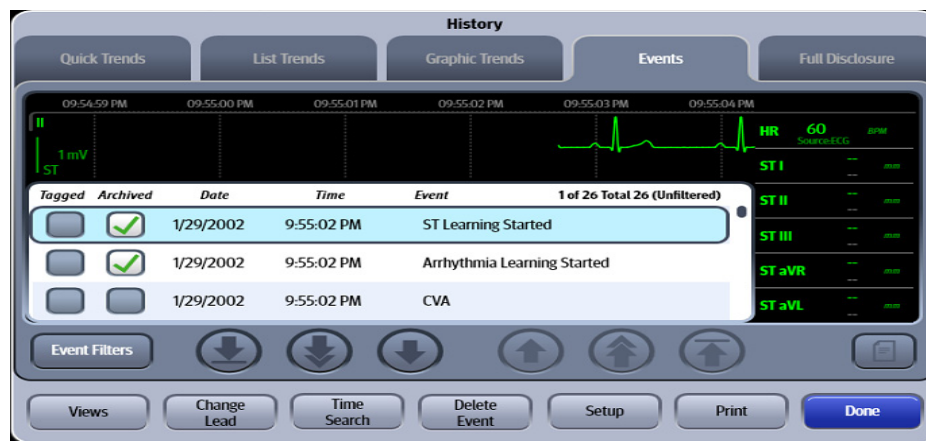

FIGURE 20-4 Example History Dialog (Events Tab List View)

20.3.2 Events - List View

20.3.3 About the Events - List View Tab







The Events - List View:

- Displays the total number of events stored in the events database.
- Displays if an event filter is in place.
- Displays the date and time for each event record.
- Displays the cursor location.
- Displays a minimum of three (3) rows without requiring scrolling.
- Displays event digital tiles to the right of the grid. The digital tiles correspond to the selected event.
- Displays the event waveform above the grid. The waveform corresponds to the selected event.

20.3.4 Navigating in the Events - List View

Navigate in this dialog by using the buttons described in TABLE 20-2.

TABLE 20-2

BUTTON	FUNCTION
	Moves the cursor to the oldest record from its current position.
	Moves the cursor one page forward from its current position.
	Moves the cursor one record forward from its current position.
	Moves the cursor up one record from its current position.
	Moves the cursor one page backward from its current position.
	Moves the cursor to the newest record from its current position.

20.3.5 Applying/Removing an Events Filter

Use event filters to help focus on a particular event type. Use an event filter based on the event type and/or the event time range.

To apply an event filter:

1. Select the **History** button from the Navigation Area.
2. Select the **Events** tab.
3. Select the **Events Filter** button to display the Event Filter dialog.
4. Optional - select the **Time Range** button to display the Time Range dialog.
5. Enter a start date and time and end date and time.
6. Optional - select the **Clear Time** button to delete the time filter.
7. Optional - select the event type using the buttons described in TABLE 20-3.

NOTE: If any of the event filter buttons are disabled, this indicates that there are no events of that kind currently contained in the Events list.

NOTE: The arrow beside an event filter button (for example, ) indicates that there is a submenu with additional choices available.

NOTE: After selecting an event filter, it displays in the Selected Filters list.

TABLE 20-3

BUTTON	DESCRIPTION / COMMENTS
Show All	Displays all events.
	NOTE: Show All is the default selection. When it is selected, the button is outlined in red.
Physiological	Displays all physiological events.
Arrhythmia	Displays all arrhythmia events.
Hemodynamics	Displays all hemodynamic events.
Gases	Displays all gas events.
Archived	Displays all archived events. The Archived button switches between None and Archived. None indicates that the filter will not include archived events. Archived indicates that the filter will include archived events.
Pressures	Displays all pressure events.
Technical	Displays all technical events.

8. Optional - to remove a filter from the Selected Filter list, select the **Remove** button.
9. Select the **Cancel** or **Accept** button.
 - The **Cancel** button closes the dialog without saving the settings.
 - The **Accept** button saves the settings and closes the dialog.

20.3.6 Tagging Events in the Events - List View

Tagging is used to delete and print multiple event records.

NOTE: A maximum of 100 event records can be tagged at one time.

To tag an event:

1. Select the **History** button from the Navigation Area.
2. Select the **Events** tab.
3. Select an event record in the list.
4. Select the Tagged box.
A check mark displays in the Tagged box.

20.3.7 Archiving Events in the Events - List View

Archiving is used to help prevent the accidental deletion of an event. Archived events cannot be deleted.

NOTE: A maximum of 100 event records can be archived at one time.

NOTE: Certain events are automatically archived. Refer to "Historical Events" on page 20-25 for additional information.

To archive an event:

1. Select the **History** button from the Navigation Area.
2. Select the **Events** tab.
3. Select an event record in the list.
4. Select the Archived box.
A check mark displays in the Archived box.

20.3.8 Changing Leads in the Events - List View

Refer to "Changing Leads" on page 20-20 for additional information.

20.3.9 Creating an Events - List View Time Search

Refer to "Configuring a Time Search" on page 20-19 for additional information.

20.3.10 Deleting Events in the Events - List View

Unarchived single events or multiple events may be deleted from the Events - List View.

To delete a single event from the list:

1. Select the **History** button from the Navigation Area.
2. Select the **Events** tab.
3. Select an event record.
4. Select the **Delete Event** button.
5. When the pop-up menu displays, select the Current option.
A message box "**Are you sure you want to delete the current event from the list?**" displays.
6. Select the **Yes** button in the message box.
The event is deleted from the list.

To delete multiple events from the list:

NOTE: A maximum of 100 event records can be deleted at one time.

1. Select the **History** button from the Navigation Area.
2. Select the **Events** tab.
3. Tag the events in the list.

NOTE: Refer to "Tagging Events in the Events - List View" on page 20-9 for additional information.

4. Select the **Delete Event** button.
5. When the pop-up menu displays, select the Tagged option.
A message box "**Are you sure you want to delete all the tagged events from the list?**" displays.
6. Select the **Yes** button in the message box.
The events are deleted from the list.

20.3.11 Configuring Displayed Parameters for the Events - List View

Refer to "Configuring Displayed Parameters" on page 20-22 for additional information.

20.3.12 Printing from the Events - List View

Refer to "Printing from the Historical Dialogs" on page 20-22 for additional information.

20.3.13 Accessing the Events - Detail View

To access the Detail view:

1. Select the **History** button from the Navigation Area.
2. Select the **Events** tab.
3. Select a physiological event in the list.

4. Select the **Views** button.

NOTE: The **Views** button is only enabled when the cursor is positioned on a physiological event.

5. Select the **Detail** option to display the event in the Detail view.

20.3.14 About the Events - Detail View

- The ECG lead displayed in the topmost position is based on the ECG lead configured as the topmost ECG waveform on the Main Screen at the time the event occurred.

NOTE: Refer to "Editing a Display Preset" on page 3-8 for additional information.

The Events - Detail View:

- Displays a minimum of four (4) seconds of waveform data in the window.
- Indicates if there is an active filter.
- Indicates if there is a note attached to the event.

20.3.15 Navigating in the Events - Detail View

Navigate in this dialog by using the buttons described in TABLE 20-4.

NOTE: When a navigation button becomes disabled, this indicates that there is no more data available or the end of the data range was reached.

TABLE 20-4









BUTTON	FUNCTION
	Moves the cursor to the first second in the event from its current position.
	Moves the cursor one page back from its current position.
	Moves the cursor one second back from its current position.
	Moves the cursor one second forward from its current position.
	Moves the cursor one page forward from its current position.
	Moves the cursor to the last second in the event from its current position.
Previous Event	Moves the cursor to the previous event in the list from its current position.
Next Event	Moves the cursor to the next event in the list from its current position.

TABLE 20-4

BUTTON	FUNCTION
	Moves the cursor up one parameter from its current position.
	Moves the cursor down one parameter from its current position.

20.3.16 **Configuring Displayed Parameters for the Events - Detail View**

Refer to "Configuring Displayed Parameters" on page 20-22 for additional information.

20.3.17 **Printing from the Events - Detail View**

Refer to "Printing from the Historical Dialogs" on page 20-22 for additional information.

20.4 Full Disclosure

Full disclosure provides an overview of all the patient's stored ECG data. View disclosure data in an overview format or a detail format. A description of both views follows.

20.4.1 Navigating to the Full Disclosure - Overview View

1. Select the **History** button from the Navigation Area.
2. Select the **Full Disclosure** tab.
The Full Disclosure - Overview View displays (as shown in FIGURE 20-5).

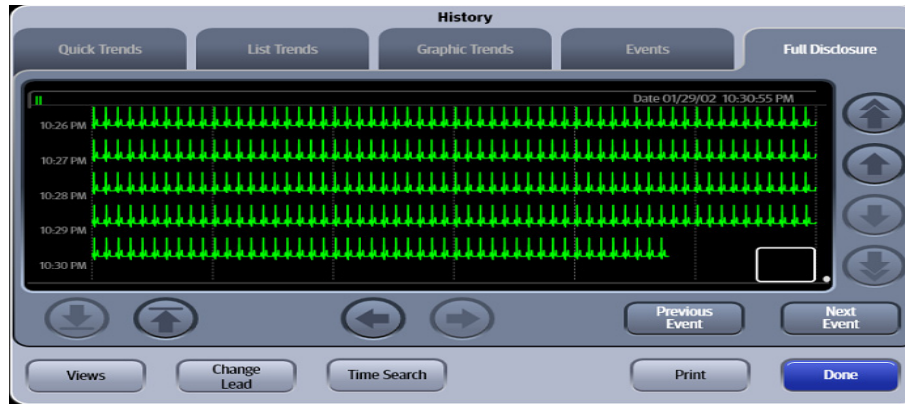

FIGURE 20-5 Example Full Disclosure Tab Overview View

20.4.2 About the Full Disclosure - Overview View

- The ECG waveform defaults to the topmost ECG waveform in the Main Screen.
- The Full Disclosure - Overview View:
 - Displays one ECG waveform at a time.
 - Displays one minute of compressed waveform data horizontally.
 - Displays historical events on the waveform at the time of the event.

20.4.3 Navigating in the Full Disclosure - Overview View

The dialog navigation buttons are described in TABLE 20-5.

NOTE: When a navigation button becomes disabled, this indicates that there is no more data available or the end of the data range was reached.

TABLE 20-5









BUTTON	FUNCTION
	Moves the cursor down to the most current ECG data.
	Moves the cursor up to the oldest historical ECG data.

TABLE 20-5

BUTTON	FUNCTION
	Moves the cursor backward five (5) seconds.
	Moves the cursor forward five (5) seconds.
Previous Event	Moves the cursor to the previous event from its current position.
Next Event	Moves the cursor to the next event from its current position.
	Moves the cursor up to the next page of historical ECG data.
	Moves the cursor up to the previous row of historical ECG data.
	Moves the cursor down to the next row of historical ECG data.
	Moves the cursor down to the next page of historical ECG data.

20.4.4 Changing Leads in the Full Disclosure - Overview View

Refer to "Changing Leads" on page 20-20 for additional information.

20.4.5 Creating a Full Disclosure - Overview View Time Search

Refer to "Configuring a Time Search" on page 20-19 for additional information.

20.4.6 Printing from the Full Disclosure - Overview View

Refer to "Printing from the Historical Dialogs" on page 20-22 for additional information.

20.4.7 Accessing the Full Disclosure - Detail View

To access the Detail View:

1. Select the **History** button from the Navigation Area.
2. Select the **Full Disclosure** tab.
3. Select the **Views** button.
4. Select the **Detail** option to display the event in the Detail view.

20.4.8 About the Full Disclosure - Detail View

Refer to "About the Events - Detail View" on page 20-11 for additional information.

20.4.9 Navigating in the Full Disclosure- Detail View

The dialog navigation buttons are described in TABLE 20-5.

NOTE: When a navigation button becomes disabled, this indicates that there is no more data available or the end of the data range was reached.

20.5 History Dialog Common Functions

20.5.1 Configuring a Display Interval

NOTE: This option is available in List Trends and the Graphic Trends.

Display intervals allow for the trends to display in a specified time interval. In List Trends if the display interval is configured for 15 min, the trends display at 11 am, 11:15 am, 11:30, etc.

In Graphic Trends, if the display interval is configured for 1 hour, a total of one hour of graphic trends data displays in the Graphic Trends display.

1. Select the **Display Interval** or **Zoom** button from the applicable History dialog tab. One of the Interval dialogs displays (as shown in FIGURE 20-6 and FIGURE 20-7).

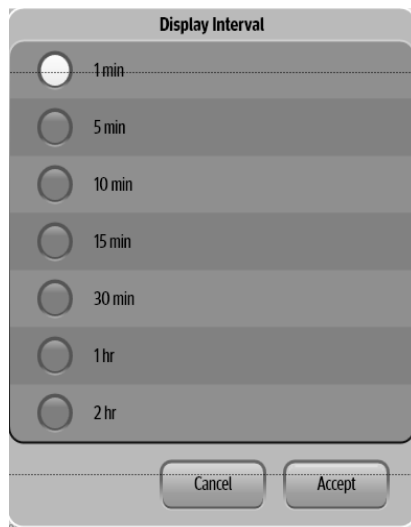

FIGURE 20-6 Example Display Interval Dialog (List Trends Tab)



FIGURE 20-7 Example Zoom Dialog (Graphic Trends Tab)

2. Select an interval.
List Trends tab choices are: **1 min**, 5 min, 10 min, 15 min, 30 min, 1 hr, 2 hr. (as shown in FIGURE 20-6)
Graphic Trends choices are: **1 hr**, 2hrs, 4hrs, 6hrs, 8hrs, 12hrs (as shown in FIGURE 20-7)

NOTE: The default display interval displays in bold.

3. Select the **Cancel** or **Accept** button.
 - The **Cancel** button closes the dialog without saving the settings.
 - The **Accept** button saves the settings and closes the dialog.
4. Optional - select the **Done** button to close the History dialog.

20.5.2 Configuring a Display Group

NOTE: This option is available in List Trends and the Graphic Trends.

Customize the parameters that display in the List Trends and the Graphic Trends by selecting one of the pre-defined parameter groups in the Display Group dialog.

1. Select the **Display Group** button from the applicable History dialog tab.
The Display Group dialog displays (as shown in FIGURE 20-8).

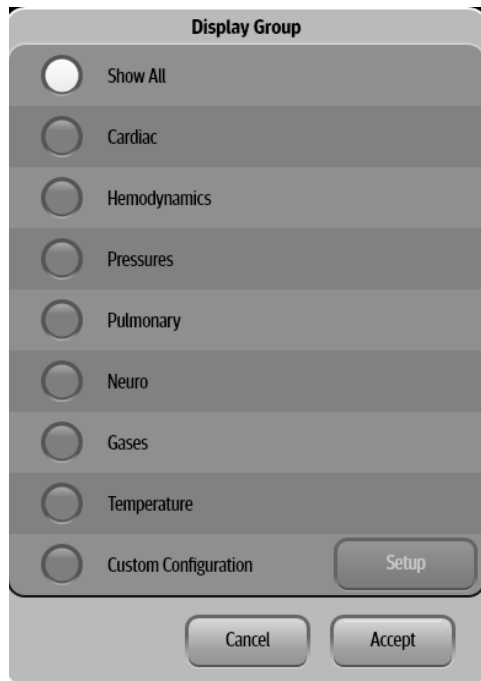

FIGURE 20-8 Example Display Group Dialog

2. Select one of the parameter groups. The choices are **Show All**, Cardiac, Hemodynamics, Pressures, Pulmonary, Neuro, Gases, Temperature, Custom Configuration.
3. Select the **Cancel** or **Accept** button.
 - The **Cancel** button closes the dialog without saving the settings.
 - The **Accept** button saves the settings and closes the dialog.
4. Optional - select the **Done** button to close the History dialog.

20.5.3 Configuring Custom Configuration Option

NOTE: This option is available in List Trends and the Graphic Trends.

Create a customized display group by using the Display Groups Custom Configuration option.

1. Select the **Display Group** button from the applicable History dialog tab
The Display Group dialog displays (as shown in FIGURE 20-8).
2. Select the **Custom Configuration** button, then select the **Setup** button.
The Display Group dialog displays (as shown in FIGURE 20-9).

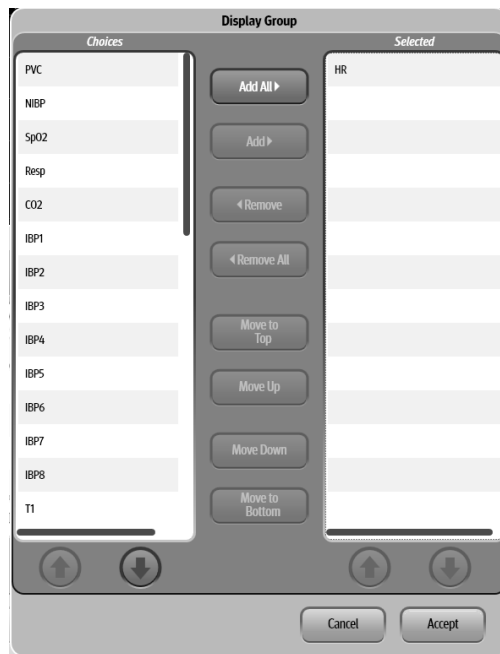



FIGURE 20-9 Example Display Group (Custom Configuration)

3. Navigate in this dialog by using the buttons described in TABLE 20-6.

TABLE 20-6

BUTTON	DESCRIPTION
Add All	Adds all the parameters on the left side of dialog to the Selected list (located on the right side of the dialog).
Add	Adds the highlighted parameter(s) to the Selected list.
	NOTE: Multiple parameters may be selected from the list.
Remove	Removes the highlighted parameter(s) from the Selected list and moves them to the Choices list.
Remove All	Removes all the selected parameters from the Selected list and moves them to the Choices list.
	NOTE: The HR parameter cannot be removed.
Move to Top	Moves the selected parameter to the position below the HR parameter in the Selected list.
Move Up	Moves the selected parameter up one position in the Selected list.
Move Down	Moves a parameter from the Selected list down one position.
Move to Bottom	Moves the selected parameter to the bottom position in the Selected list.
	Scrolls up the Choices or Selected lists.
	Scrolls down the Choices or Selected lists.

4. Continue to select the **Cancel** or **Accept** button to return to the Main display.
 - The **Cancel** button closes the dialog without saving the settings.
 - The **Accept** button saves the settings and closes the dialog.
5. Optional - select the **Done** button to close the History dialog.

20.5.4 Configuring a Time Search

NOTE: This option is available in **List Trends, Graphic Trends, Events - List view, and Full Disclosure - Overview view.**

Minimize the number of records that display by creating a time filter or search.

1. Select the **Time Search** button from the applicable History dialog tab.
The Time Search dialog displays (as shown in FIGURE 20-10).

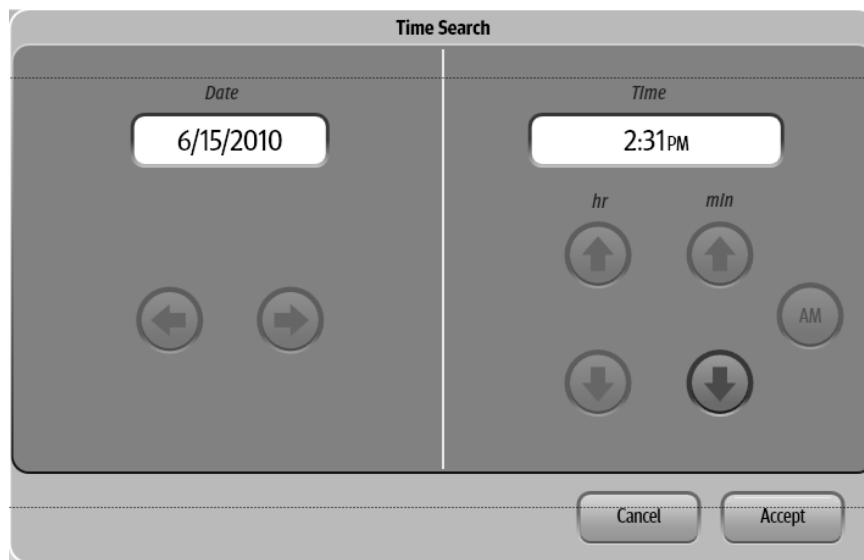

FIGURE 20-10 Example Time Search Dialog

2. Use the left and right arrow keys to scroll to the date needed.
3. Use the up and down arrow keys to scroll to the time needed.
4. Use the AM/PM button to toggle between AM and PM.
5. Select the **Cancel** or **Accept** button.
 - The **Cancel** button closes the dialog without saving the settings.
 - The **Accept** button saves the settings and closes the dialog.
6. Optional - select the **Done** button to close the History dialog.

20.5.5 Changing Leads

NOTE: This option is available in the Events views and the Full Disclosure views.

The historical tabs display one ECG lead at a time. Any of the leads active during the time of the event may be viewed.

NOTE: Refer to the "Events Tab" on page 20-7 and "Full Disclosure" on page 20-13 for additional information.

To view a different lead:

1. Select the **Change Lead** button from the applicable History dialog tab.
2. Select a lead from the list.
The new lead now displays in the top left corner of the data window and the data updates accordingly to reflect the selected lead.

20.5.6 Adding/Deleting Event Notes

NOTE: This option is available in the Events view.

Clinical notes may be added to or deleted from an event record. The system displays an indication that a note is attached to the event.

NOTE: The Notes dialog accepts a total of 80 alphanumeric characters.

To add a note:

1. Select the  icon from the applicable History dialog view.
The Notes dialog displays.
2. Select the **Edit** button to display the keyboard dialog.
3. Enter the text using the on-line keyboard.
4. Select the **Cancel** or **Accept** button.
 - The **Cancel** button closes the dialog without saving the settings.
 - The **Accept** button saves the settings and closes the dialog.
5. Optional - select the **Done** button to close the History dialog.

To delete a note:

1. Select the  icon from the applicable History dialog view.
The Notes dialog displays.
2. Select the **Delete** button.
3. Select the **Cancel** or **Accept** button.
 - The **Cancel** button closes the dialog without saving the settings.
 - The **Accept** button saves the settings and closes the dialog.
4. Optional - select the **Done** button to close the History dialog.

20.5.7 Performing ECG Waveform Measurements

NOTE: This option is available in the Events List - Detail view and the Full Disclosure - Detail view.

Perform ECG waveform measurements by using the Calipers dialog.

Caliper Vertical Measurements (Timing)

1. Select the  icon from the applicable History dialog detail view.
2. Select either the PR, QRS, QT, or R to R intervals.
A dashed vertical reference line is placed to the left of the solid vertical reference line.

NOTE: Adjustments can be made to both the solid vertical reference line and/or the vertical dashed reference line. Selecting the interval button a second time toggles between the two reference lines. When a reference line is active, it blinks/ flashes on the screen.

3. Adjust the location of the vertical reference line as follows:
 - For coarse adjustments, select the desired location on the touch screen. The reference line will move to that point.
 - For fine adjustments, use the left/right arrow buttons to position the reference line at the desired point.
4. Select the **Calculate** button once the vertical reference line appears in the desired location. The measurement populates the text box beside the selected interval.
 - If another vertical measurement is desired, select another interval button.
 - To delete a measurement, select the interval button that needs to be to reset, then select the **Clear** button.

Caliper Horizontal Measurements (Amplitude)

1. Select the  icon from the applicable History dialog detail view.
2. Select the ST interval button.
A dashed horizontal reference line is placed above the solid horizontal reference line.

NOTE: Adjustments can be made to both the horizontal solid reference line and/or the horizontal dashed reference line. Selecting the interval button a second time toggles between the two reference lines. When a reference line is active, it blinks/ flashes on the screen.

3. Adjust the location of the dashed, horizontal reference line as follows:
 - For coarse adjustments, select the desired location on the touch screen. The reference line will move to that point.
 - For fine adjustments, use the up/down arrow buttons to position the reference line at the desired point.
4. Once the dashed, horizontal reference line appears in the desired location, select the **Calculate** button. The measurement populates the text box beside the ST interval.
 - If another horizontal measurement is desired, select another interval button.
 - To delete the ST measurement, select the ST interval button, then select the **Clear** button.

20.5.8 Configuring Displayed Parameters

NOTE: This option is available in the Event views and the Full Disclosure - Detail view.

To configure the parameters that display in the Events - List View, Events - Detail view and Full Disclosure - Detail view use the **Setup** button.

1. Select the **Setup** tab from the applicable History dialog tab.
The History Setup dialog displays.
2. Select the **Configure Parameters** button.
The Configure Parameters dialog displays.
3. Navigate in the dialog by using the buttons described in TABLE 20-7.

TABLE 20-7

BUTTON	DESCRIPTION
Add All	Adds all the parameters to the Selected list (located to the right of the navigation buttons).
Add	Adds the selected choice to the Selected list (located to the right of the navigation buttons).
Remove	Removes the selected choice from the Selected list.
Remove All	Removes all the choices from the Selected list and moves them back to the Choices list (located to the left of the navigation buttons).
NOTE: The HR parameter cannot be removed.	
Move to Top	Moves the highlighted choice to the top position in the Selected list.
Move Up	Moves the choice in the Selected list up one position.
Move Down	Moves the choice from the Selected list down one position.
Move to Bottom	Moves the cursor up by one in the Selected list.

4. Continue to select the **Cancel** or **Accept** button to return to the Main display.
 - The **Cancel** button closes the dialog without saving the settings.
 - The **Accept** button saves the settings and closes the dialog.
5. Optional - select the **Done** button to close the History dialog.

20.5.9 Printing from the Historical Dialogs

The Print dialog is available from the all of the historical dialogs. Up to 24 hours of trends, events, and full disclosure data may be printed, and up to 12 hours of graphic trends data may be printed.

To print the historical data contained in these historical dialogs:

NOTE: Refer to the "Reports" on page 19-1 for a full description of the reports and sample reports.

1. Select the **Print** button from the applicable History dialog tab.
The Print dialog displays (as shown in FIGURE 20-11 and FIGURE 20-12).

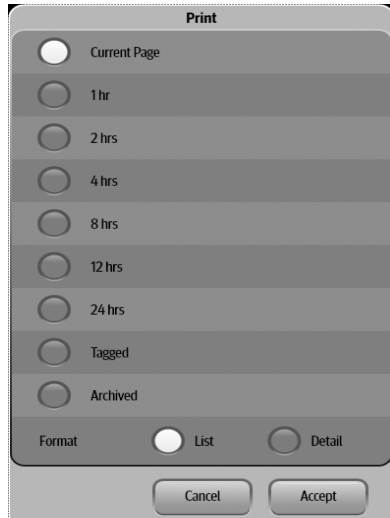

FIGURE 20-11 Example Display Interval Dialog (Events - List View)



FIGURE 20-12 Example Print Dialog (Graphic Trends)

2. Select an interval. The potential choices are **Current**, 1 hr, 2 hrs, 4 hrs, 8 hrs, 12 hrs, 24 hrs, Tagged, and Archived. Refer to TABLE 20-8 for additional information.

TABLE 20-8

TIME INTERVAL	PRINTS
Current Page	Only prints the four displayed events in the dialog including the digital parameter values associated with the events.
Current	Prints the displayed time period of patient data.
1 hr	Prints one hour of patient data, beginning at 1/2 before the cursor time and printing up to and including the cursor time.
2 hrs	Prints two hours of patient data, beginning at one hour before the cursor time and printing up to and including the cursor time.
4 hrs	Prints four hours of patient data, beginning at two hours before the cursor time and printing up to and including the cursor time.
8 hrs	Prints eight hours of patient data, beginning at four hours before the cursor time and printing up to and including the cursor time.
12 hrs	Prints 12 hours of patient data, beginning at six hours before the cursor time and printing up to and including the cursor time.
24 hrs	Prints 24 hours of patient data, beginning at 12 hours before the cursor time and printing up to and including the cursor time.
	NOTE: Up to 12 hours of Graphic Trends data may be printed. The 24 hour option does not exist in Graphic Trends.
Tagged	Prints all the events with the Tagged check box selected.

TABLE 20-8

TIME INTERVAL	PRINTS
Archived	Prints all the events with the Archived check box selected.

NOTE: **The Tagged and Archived options are only available when printing from the Events - List view.**

3. Select the **Cancel** or **Accept** button.
 - The **Cancel** button closes the dialog without saving the settings.
 - The **Accept** button saves the settings and closes the dialog.
4. Optional - select the **Done** button to close the History dialog.

20.6 Historical Events

TABLE 20-9 lists all the storable events. The events may be physiological, technical, or informational. The asterisk (*) beside the event message name indicates that the event is automatically archived and cannot be deleted from the Events database.

TABLE 20-9

PARAMETER	MESSAGE	EVENT/ALARM TYPE
ARRHYTHMIA		
	Asystole	Physiological
	Ventricular Tachycardia	Physiological
	Ventricular Fibrillation	Physiological
	Bigeminy	Physiological
	Bradycardia	Physiological
	Couplet	Physiological
	Irregular Heart Rate	Physiological
	Multiform PVC	Physiological
	Pause	Physiological
	Pause Per Minute	Physiological
	R-On-T PVC	Physiological
	PVCs / Minute Alarm Violation	Physiological
	Run	Physiological
	Trigeminy	Physiological
	Ventricular Rhythm	Physiological
	Arrhythmia Learning Started*	Informational
	Asystole Configured On*	Informational
	Asystole Config Off*	Informational
	Ventricular Tachycardia Configured On*	Informational
	Ventricular Tachycardia Config Off*	Informational
	Ventricular Fibrillation Configured On*	Informational
	Ventricular Fibrillation Config Off*	Informational
	Learning	Informational

* Indicates that event cannot be deleted from the Events database.

TABLE 20-9 (Continued)

PARAMETER	MESSAGE	EVENT/ALARM TYPE
ECG		
	<Lead> Off (<Lead> is the corresponding lead name)	Technical
	Leads Off*	Technical
	ECG Noise	Technical
HR		
	HR High Alarm Violation	Physiological
	HR High Alarm Violation	Physiological
TEMPERATURE		
	<Temperature Label> High Alarm Violation	Physiological
	<Temperature Label> High Alarm Violation	Physiological
	Delta T High Alarm Violation	Physiological
SPO₂		
	SpO ₂ High Alarm Violation	Physiological
	SpO ₂ Low Alarm Violation	Physiological
	No Sensor	Technical
	Sensor Off	Technical
	Sat Seconds	Technical
NIBP		
	NIBP Systolic High Alarm Violation	Physiological
	NIBP Systolic Low Alarm Violation	Physiological
	NIPB Diastolic High Alarm Violation	Physiological
	NIPB Diastolic Low Alarm Violation	Physiological
	NIPB Mean High Alarm Violation	Physiological
	NIPB Mean Low Alarm Violation	Physiological
IBP		
	IBPX Systolic High Alarm Violation	Physiological
	IBPX Systolic Low Alarm Violation	Physiological
	IBPX Diastolic High Alarm Violation	Physiological
	IBPX Diastolic Low Alarm Violation	Physiological
	IBPX Mean High Alarm Violation	Physiological
	IBPX Mean Low Alarm Violation	Physiological
RESP		
	Apnea	Physiological
	Respiration High Alarm	Physiological
	Respiration Low Alarm	Physiological
	CVA	
	Apnea Detection*	Informational

* Indicates that event cannot be deleted from the Events database.

TABLE 20-9 (Continued)

PARAMETER	MESSAGE	EVENT/ALARM TYPE
ST		
	ST Single Alarm Violation	Physiological
	ST Dual Alarm Violation	Physiological
	ST On*	Informational
	ST Off*	Informational
	ST Learning Started*	Informational
PAWP		
	Accept PAWP	Physiological
CO₂		
	Inspired CO ₂ High Alarm	Physiological
	End Tidal CO ₂ High Alarm	Physiological
	End Tidal CO ₂ Low Alarm	Physiological
	CO ₂ Occlusion	Technical
	CO ₂ Failure	Technical
CO		
	T Blood High Alarm Violation	Physiological
	T Blood Low Alarm Violation	Physiological
	CO Accepted	Physiological
CCO		
	CCO High Alarm Violation	Physiological
	CCO Low Alarm Violation	Physiological
	CCI High Alarm Violation	Physiological
	CCI Low Alarm Violation	Physiological
	SVR High Alarm Violation	Physiological
	SVR Low Alarm Violation	Physiological
	SVRI High Alarm Violation	Physiological
	SVRI Low Alarm Violation	Physiological
	EDV High Alarm Violation	Physiological
	EDV Low Alarm Violation	Physiological
	EDVI High Alarm Violation	Physiological
	EDVI Low Alarm Violation	Physiological
	RVEF High Alarm Violation	Physiological
	RVEF Low Alarm Violation	Physiological
	SV High Alarm Violation	Physiological
	SV Low Alarm Violation	Physiological
	SVI High Alarm Violation	Physiological
	SVI Low Alarm Violation	Physiological
	CCO STAT High Alarm Violation	Physiological
	CCO STAT Low Alarm Violation	Physiological

* Indicates that event cannot be deleted from the Events database.

TABLE 20-9 (Continued)

PARAMETER	MESSAGE	EVENT/ALARM TYPE
	CCI STAT High Alarm Violation	Physiological
	CCI STAT Low Alarm Violation	Physiological
	EDV High Alarm Violation	Physiological
	EDV Low Alarm Violation	Physiological
	EDVI High Alarm Violation	Physiological
	EDVI Low Alarm Violation	Physiological
	RVEF STAT High Alarm Violation	Physiological
	RVEF STAT Low Alarm Violation	Physiological
	SV STAT High Alarm Violation	Physiological
	SV STAT Low Alarm Violation	Physiological
	SVI STAT High Alarm Violation	Physiological
	SVI STAT Low Alarm Violation	Physiological
	Check Vigilance	Technical
GASES		
	ET O2 High Alarm Violation	Physiological
	ET O2 Low Alarm Violation	Physiological
	Insp O2 High Alarm Violation	Physiological
	Insp O2 Low Alarm Violation	Physiological
	ET N2O High Alarm Violation	Physiological
	ET N2O Low Alarm Violation	Physiological
	Insp N2O High Alarm Violation	Physiological
	Insp N2O Low Alarm Violation	Physiological
	ET Des High Alarm Violation	Physiological
	ET Des Low Alarm Violation	Physiological
	Insp Des High Alarm Violation	Physiological
	Insp Des Low Alarm Violation	Physiological
	ET Enf High Alarm Violation	Physiological
	ET Enf Low Alarm Violation	Physiological
	Insp Enf High Alarm Violation	Physiological
	Insp Enf Low Alarm Violation	Physiological
	ET Hal High Alarm Violation	Physiological
	ET Hal Low Alarm Violation	Physiological
	Insp Hal High Alarm Violation	Physiological
	Insp Hal Low Alarm Violation	Physiological
	ET Iso High Alarm Violation	Physiological
	ET Iso Low Alarm Violation	Physiological
	Insp Iso High Alarm Violation	Physiological
	Insp Iso Low Alarm Violation	Physiological
	ET Sev High Alarm Violation	Physiological
	ET Sev Low Alarm Violation	Physiological
	Insp Sev High Alarm Violation	Physiological

* Indicates that event cannot be deleted from the Events database.

TABLE 20-9 (Continued)

PARAMETER	MESSAGE	EVENT/ALARM TYPE
	Insp Sev Low Alarm Violation	Physiological
	Mixed Agents	Physiological
	MAC > 3	Physiological
	Gas Module Disconnected	Physiological
	Occlusion	Physiological
	Gas Module Failure	Technical
rSO2		
	rSO2 High Alarm Violation	Physiological
	rSO2 Low Alarm Violation	Physiological
	Check INVOS	Technical
SVO2		
	SvO2 High Alarm Violation	Physiological
	SvO2 Low Alarm Violation	Physiological
	Check Vigilance	Technical
MAIN SCREEN		
	Low Battery	Physiological
	Fan Failure	Physiological
	Communications Lost	Technical

* Indicates that event cannot be deleted from the Events database.

20.7 Troubleshooting

ISSUE*	REASON	SOLUTION
Navigation arrows are not available	There is no data going in the direction of the selected arrow.	Check the patient's admit time or date. Already at the top or bottom or far left or far right of a list.
Quick Trends list is empty	The list does not populate until an NIBP measurement is taken.	Take an NIBP measurement.
No Further Events	There are no earlier or later event from where the cursor is currently positioned.	Select a button to move forward or backward.
Cannot delete event	Event is archived. Event cannot be deleted.	Uncheck the archived checkbox. Certain events cannot be deleted.
Too many archived events!	Attempted to archive more than 100 events.	Only able to archive 100 events at one time. Uncheck some events.
Too many tagged events!	Attempted to tag more than 100 events.	Only able to tag 100 events at one time. Uncheck some events.
Can not set the Archive status for this event!	To prevent deleting, the selected event cannot be unarchived.	No solution required.

* *Messages are shown in all bold text.*

Calculators

Hemodynamics Calculations.....	21-2
Hemodynamics Dialog.....	21-2
Hemodynamic Calculations Report	21-6
Hemodynamic Calculations Troubleshooting.....	21-6
Drug Calculations	21-7
Drug Calculator Dialog	21-7
Drug Calculations Report	21-15
Drug Calculator Troubleshooting.....	21-15

21.1 Hemodynamics Calculations

Hemodynamic calculations are a set of values used to determine the hemodynamic status of the patient. The following values are necessary for these calculations: height, weight, CO, HR, Mean ART, Mean PA, PAWP and Central Venous Pressure (CVP).

All manually entered values (such as PAWP) are denoted with an asterisk (*).

Patient Sizes

Intended patient types: Adult, Pediatric. The Hemodynamic Calculations are not available when the patient size is set to Neonate.

VPS

Hemodynamic calculations are part of the **V 12/V 21** and do not function as part of the VPS.

21.2 Hemodynamics Dialog

The Hemodynamic dialog (as shown in FIGURE 21-1) contains a **Calculator** tab and a **Log** tab. A description of each tab follows.

21.2.1 Navigating to the Calculator Tab

- Select the **Procedures** tab, then select the **Hemo Calculations** button.
The Hemodynamics dialog displays (as shown in FIGURE 21-1)

OR

1. Select the **Tools** tab from the Navigation Area.
2. Select the **Calculators** button, then select the **Hemo Calculations** button.

Date	Time			
BSA				m ²
CI				L/min/m ²
SV				mL
SVI				mL/m ²
SVR				dyne-sec/cm ⁵
SVRI				dyne-sec/cm ⁵ /m ²
PVR				dyne-sec/cm ⁵
PVRI				dyne-sec/cm ⁵ /m ²
LCW				kg-m
LCWI				kg-m/m ²
RCW				kg-m
RCWI				kg-m/m ²
LVSW				g-m

Height: Unspecified MAP: --

Weight: 159.0 kg = 350.5 lbs ART Diastolic: --

CO: -- Mean PA: --

HR: 60 bpm PAWP: --

Ejection Fraction: -- CVP: --

Calculate Done

FIGURE 21-1 Example Hemodynamics Calculator

21.2.1.1 Configuring the Calculator Tab

1. Select the **Procedures** tab, then select the **Hemo Calculations** button.
2. If necessary, select the **Calculator** tab.
3. Select the buttons described in TABLE 21-1 to configure the tab.

NOTE: All manually entered values or edited values are denoted with an asterisk (*).

TABLE 21-1

BUTTON	DESCRIPTION / COMMENTS
Height	Select to enter or change patient's height. Factory default is a blank value.
Weight	Select to enter or change patient's weight. Factory default is a blank value.
	NOTE: Height and weight are required to calculate index values.
CO	Defaults to the current CO value when the Hemodynamic dialog displays, but the value may be edited.
	NOTE: If the Hemodynamic CO parameter is manually entered, the CO time is updated accordingly.
HR	Defaults to the current HR value when the Hemodynamic dialog displays.
Ejection Fraction	Select to enter the ejection fraction parameter value. Factory default is a blank value.
MAP	Defaults to the current Mean Arterial Pressure (MAP) value when the Hemodynamic dialog displays. The source of the MAP displays.
ART Diastolic	Defaults to the Diastolic Arterial Pressure (DAP) value when the Hemodynamics dialog displays.
Mean PA	Defaults to the current mean PA value when the Hemodynamics dialog displays.
PAWP	Defaults to the PAWP value when the Hemodynamics dialog displays.
	NOTE: If the Hemodynamic PAWP parameter is manually entered, the PAWP time is updated accordingly.
CVP	This button is hidden if no IBP channel is labeled CVP, but an IBP channel is labeled as RA.
	NOTE: CVP value defaults to the mean CVP value when an IBP channel is labeled CVP. When no IBP channel is labeled CVP or RA, the CVP value is displayed as invalid (- -) until the CVP value is manually entered.
RA	This button is only visible if no IBP channel is labeled CVP and an IBP channel is labeled as RA.
	NOTE: Defaults to the mean RA value.

4. Select the **Calculate** button. The formulas found in TABLE 21-2 are used to determine the hemodynamic calculations:

TABLE 21-2 Hemodynamic Calculations

ABBREVIATION / UNITS	DESCRIPTION	FORMULA
BSA (m ²)*	Body Surface Area	$Ht^{0.725}(\text{cm}) \times Wt^{0.425}(\text{kg}) \times 0.007184$
CI (l/min/m ²)	Cardiac Index	CO / BSA
SV (ml)/beat	Stroke Volume	(CO / HR) x 1000
SVI (ml/beat/m ²)	Stroke Volume Index	SV / BSA
SVR (dyne-sec/cm ⁵)	Systemic Vascular Resistance	(ART mean-CVP) / CO) x 79.96, Or, (ART mean-RA) / CO) x 79.96
NOTE: When an IBP channel is labeled RA and no other IBP channel is labeled CVP, the RA value is used in calculating SVR and RVS.		
SVRI (dyne-sec/cm ⁵ /m ²)	Systemic Vascular Resistance Index	SVR x BSA
PVR (dyne-sec/cm ⁵)	Pulmonary Vascular Resistance	(PA mean-PAWP) / CO) x 79.96
PVRI (dyne-sec/cm ⁵ /m ²)	Pulmonary Vascular Resistance Index	PVR x BSA
LCW (kg-m)	Left Cardiac Work	0.0136 x ART mean x CO
LCWI (kg-m/m ²)	Left Cardiac Work Index	LCW / BSA
RCW (kg-m)	Right Cardiac Work	0.0136 x PA mean x CO
RCWI (kg-m/m ²)	Right Cardiac Work Index	RCW / BSA
LVS (g-m)/beat	Left Ventricular Stroke Work	SV x (ART mean-PAWP) x 0.0136
LVSI (g-m/beat/m ²)	Left Ventricular Stroke Work Index	LVS / BSA
RVS (g-m)/beat	Right Ventricular Stroke Work	SV x (PA mean - CVP) x 0.0136, Or, SV x (PA mean - RA) x 0.0136
NOTE: When an IBP channel is labeled RA and no other IBP channel is labeled CVP, the RA value is used in calculating SVR and RVS.		
RVSI (g-m/beat/m ²)	Right Ventricular Stroke Work Index	RVS / BSA
CoPP (mmHg)	Coronary Artery Perfusion Pressure	Coronary Perfusion Pressure = Diastolic ART Blood Pressure - PAWP
EDV (ml)	End-Diastolic Volume	End Diastolic Volume = SV / (EF / 100%)
EDVI (ml/m ²)	End-Diastolic Volume Index	End Diastolic Volume Index = EDV / BSA
ESV (ml)	End-Systolic Volume	End Systolic Volume = EDV - SV
ESVI (ml/m ²)	End-Systolic Volume - Index	End Systolic Volume Index = ESV / BSA





* *Dubois' equation*

- Select the **Done** button to close the Hemodynamics dialog.

21.2.1.2 About the Calculator Tab

- The calculator displays the calculated parameters in the following order: BSA, CI, SV, SVI, SVR, SVRI, PVR, PVRI, LCW, LCWI, RCW, RCWI, LVSW, LVSWI, RVSW, RVSWI, CoPP, EDV, EDVI, ESV, ESVI.
- With the exception of the patient BSA, the calculator indicates when a parameter was manually entered.
- The calculator displays the three most recent sets of calculations in a tabular format. Each set includes a date and timestamp.
- The most recent data displays in the right most position; followed by the second most recent in the middle position; ending with the oldest calculations in the far left position.
- Up and down arrows display beside the table to scroll vertically through the list.

21.2.2 Navigating to the Log Tab

1. Select the **Procedures** tab, then select the **Hemo Calculations** button.
2. If necessary, select the **Log** tab.
3. Optional - scroll through the list using the following buttons:
 - Select the  arrow key to move up the list.
 - Select the  arrow key to move down the list.
 - Select the  arrow key to move to the oldest set of calculations.
 - Select the  arrow key to move to the newest set of calculations.
4. Optional - select the **Print** button to print currently displayed calculations to the default printer.
5. Select the **Done** button to close the Hemodynamics dialog.

21.2.2.1 About the Log Tab

- The log displays all the calculated parameters.
- With the exception of the patient BSA, the log indicates when a parameter was manually entered.
- The log displays the nine most recent sets of calculations in a tabular format. Each set includes a date and timestamp.
- The most recent calculations data displays in the right most position.
- The oldest calculations data displays in the left most position.

21.3 Hemodynamic Calculations Report

Refer to "Hemodynamic Calculation Report" on page 19-39 for additional information.

21.4 Hemodynamic Calculations Troubleshooting

MESSAGE/PROBLEM	REASON	SOLUTION
Dashes "--" display in place of numerics.	All the required information was not entered.	Height and weight are required to calculate indices.
Value out of range	An invalid value was entered in the keypad.	The acceptable range displays above the text box. Observe the range, then enter a value within the range.

21.5 Drug Calculations

The **V 12/V 21** has the ability to calculate and display IV drug infusion rate and concentration based upon patient weight and/or drug dosage.

Patient Sizes

Intended patient types: Adult.

VPS

Hemodynamic calculations are part of the **V 12/V 21** and do not function as part of the VPS.

21.6 Drug Calculator Dialog

The Drug Calculator dialog (as shown in FIGURE 21-2) contains a **Calculator** tab and a **Titration Table** tab. A description of each tab follows.

21.6.1 Navigating to the Drug Calculator Dialog

1. Select the **Tools** tab from the Navigation Area.
2. Select the **Calculators** button.
3. Select the **Drug** button.
The Drug Calculator dialog displays (as shown in FIGURE 21-2).

The screenshot shows the 'Drug Calculator' dialog box. At the top, it says 'Drug Calculator' and 'Previous Calculations' with 'No Previous Calculations' and up/down arrows. Below are two tabs: 'Calculator' (selected) and 'Titration Table'. The 'Calculator' tab contains the following fields:

Drug Name	Diltiazem/Cardizem
Weight Based	Yes
Weight	150.0 kg = 330.7 lbs
Drug Amount	125.0 mg
Solution Vol	125 ml
Dose/kg	Unspecified
Infusion Rate	Unspecified

At the bottom of the dialog, there is a field for 'Concentration = 1.0 mg/ml' and two buttons: 'Delete selected' and 'Done'.

FIGURE 21-2 Example Drug Calculator

21.6.2 Configuring a Drug Calculation

1. Select the **Tools** tab from the Navigation Area.
2. Select the **Calculators** button.
3. Select the **Drug** button.
4. Select the buttons described in TABLE 21-3 to configure the tab.

TABLE 21-3

BUTTON	DESCRIPTION / COMMENTS	CHOICES*
Drug Name	Select a drug from the list.	Refer to TABLE 21-4 for a full list of drug names. Unspecified
Weight Based	Configure whether the drug calculation is weight based or not. NOTE: The weight based choices are only available after selecting the drug name.	Yes, No
Weight	If the Weight Based button is enabled, enter the patient's weight. NOTE: Refer to "Weight Requirements" on page 21-10 for additional information.	N/A Accepts entered weight in pounds (lbs) or kilograms (kg).
Drug Amount	Enter the drug amount based on hospital's formulary.	N/A Accepts entered drug amounts in mcg (micrograms), mg (milligrams), or g (grams) for all drugs other than Drugs A, B, C, and D. Accepts entered drug amounts in mcg (micrograms), mg (milligrams), g (grams), units, mU for Drugs A, B, C, and D.
Solution Vol	Enter the drug amount based on the hospital's formulary.	N/A Accepts entered solution volumes in milliliters (ml).
Dose	Enter the drug dose.	N/A Accepts entered dosages in mcg (micrograms), mg (milligrams), or g (grams). Accepts dosage in minutes or hours.
Infusion Rate	Infusion rate is automatically calculated based on the dosage.	

* *The factory default configuration settings are in bold.*

5. Select the **Done** button.

21.6.2.1 Drug List and Requirements

- The drug name choices are listed by generic drug name in alphabetical order except for the generic drugs Drug A, B, C, D which appear last in the list.
- When Drug A, B, C, D are selected, the drug calculator displays an alphanumeric keyboard to enter a drug name.

NOTE: Enter a maximum of 30 characters for the generic drug name.

- When Milrinone is the chosen drug, the weight-based setting is set to Yes and it cannot be changed.
- The default value for the weight based setting is dependent on the drug name.

TABLE 21-4

DRUG NAME/GENERIC NAME	WEIGHT BASED SETTING	DRUG DOSE UNITS	DRUG AMOUNT	SOLUTION VOLUME	TITRATION TABLE INCREMENT
Aminophylline / Theophylline	Yes	mg	500 mg	500 ml	1
Diltiazem / Cardizem	No	mg	125 mg	125 ml	1
Dobutamine / Dobutrex	Yes	mcg	500 mg	250 ml	1
Dopamine / Inotropin	Yes	mcg	400 mg	250 ml	1
Epinephrine HCL / Adrenalin	No	mcg	1 mg	250 ml	1
Esmolol HCL / Brevibloc	Yes	mcg	5000 mg	500 ml	1
Fentanyl Citrate / Sublimaze	Yes	mcg	5 mg	100 ml	1
Heparin Sodium / Heparin	No	units	12,500 units	250 ml	1
Inamrinone Lactate / Inocor	Yes	mcg	500 mg	250 ml	1
Insulin/ Humulin	No	units	100 units	100 ml	1
Isoproterenol HCL / Isuprel HCL	No	mcg	2 mg	500 ml	1
Labetalol HCL / Normodyne	No	mg	200 mg	200 ml	1
Lidocaine HCL / Xylocaine HCL	No	mg	2000 mg	500 ml	1
Lorazepam / Ativan	No	mg	40 mg	500 ml	1
Midazolam HCL / Versed	Yes	mg	125 mg	125 ml	1
Milrinone Lactate / Primacor	Yes	mcg	20 mg	200 ml	0.125
Nicardipine HCL / Cardene	No	mg	25 mg	250 ml	1
Nitroglycerin / Tridil	No	mcg	50 mg	250 ml	1
Nitroprusside Sodium / Nipride	Yes	mcg	50 mg	250 ml	1
Norepinephrine / Levophed	No	mcg	4 mg	250 ml	1

** Indicates that the drug amounts are programmable for generic drugs. For all other drugs, units are not programmable.*

TABLE 21-4

DRUG NAME/GENERIC NAME	WEIGHT BASED SETTING	DRUG DOSE UNITS	DRUG AMOUNT	SOLUTION VOLUME	TITRATION TABLE INCREMENT
Phenylephrine / Neosynephrine	No	mcg	10 mg	250 ml	1
Procainamide HCL / Pronestyl	No	mg	2000 mg	500 ml	1
Propofol / Diprivan	Yes	mcg	500 mg	50 ml	1
Vasopressin / Pitressin	No	units	250 units	250 ml	1
Drug A	Yes	mcg*	Unspecified	Unspecified	1
Drug B	Yes	mcg*	Unspecified	Unspecified	1
Drug C	Yes	mcg*	Unspecified	Unspecified	1
Drug D	Yes	mcg*	Unspecified	Unspecified	1

** Indicates that the drug amounts are programmable for generic drugs. For all other drugs, units are not programmable.*

21.6.2.2 Weight Requirements

- Entering a weight is only permitted when a weight based drug is selected.
- Entered weights for a specific drug calculation take effect immediately.
- Weight entered via the drug calculator is saved to the demographic database and remains in the calculator for the patient until it is changed.
- The weight originally entered for previous calculations remains persistent even if the weight for new calculations was changed.

21.6.2.3 Drug Amount Requirements

- Entering a drug amount is only permitted after choosing a drug.
- The default values for the drug amount when Drug A, B, C, or D is chosen drug is Unspecified.
- The drug calculation software provides an error message when the entered amount is invalid.
- The default drug amount values for any other drug other than Drug A, B, C, or D is dependent on the factory defaults. Refer to TABLE 21-4 for a listing of all the factory default settings.
- When the current drug is Drug A, B, C, or D, the drug calculator allows the drug amount to be entered.
- For all drugs other than Drug A, B, C, or D, the values for drug amounts are restricted to units and mU.

21.6.2.4 Solution Volume Requirements

- Solution volume only displays after selecting a drug name.
- Default values for solution volume when Drug A, B, C, or D is chosen drug is Unspecified.
- The solution volume resets to Unspecified if the drug amount unit family is changed for Drug A, B, C, or D.
- The drug calculation software checks for invalid or out of range entries.
- The default drug values for any other drug other than Drug A, B, C, or D is dependent on the factory defaults. Refer to TABLE 21-4 for a listing of all the factory default settings.

21.6.2.5 Non-Weight Based Dose Requirements

- The dose button is only available when a non-weight based drug is selected.
- The dose value can either be entered manually or calculated.
- Enter the dose in dose/minute or dose/hour.
- The factory default dose time is dose/minute.
- When the drug amount units are mcg, mg, or g, the drug calculator provides dose units choices of mcg, mg, and g.
- When the drug amount units are mU, the drug calculator provides the dose unit choice of mU.
- The drug calculation software checks for invalid or out of range entries for manually entered values.
- The drug calculation software calculates the dose value provided all of the following information is entered: drug name, drug amount, solution volume, and infusion rate.
- When calculating the dose, the drug calculation software checks for overflow and underflow and displays the dose as invalid data in either of these cases.
- The dose value defaults to Unspecified and remains Unspecified until the value is either calculated or manually entered.

21.6.2.6 Weight Based Dose Requirements

- The dose value can either be entered manually or calculated.
- A valid weight must exist before the drug calculation software will calculate the dose value.
- Enter the dose in dose/kg/minute or dose/kg/hour when the chosen drug is anything other than Milrinone.
- Enter the dose only in dose/kg/minute when the chosen drug is Milrinone.
- The drug calculator provides a factory default dose/kg time units to dose/kg/minute.
- When the drug amount units are mcg, mg, or g, the drug calculator provides dose units choices of mcg, mg, and g.
- When the drug amount units are mU, the drug calculator provides the dose unit choice of mU.
- The drug calculation software checks for invalid or out of range entries for manually entered values.
- The drug calculation software calculates the dose value provided all of the following information is entered: drug name, patient weight, drug units, drug amount, solution volume, and infusion rate.
- When calculating the dose/kg, the drug calculation software checks for overflow and underflow and displays the dose/kg as invalid data in either of these cases.

- The dose/kg value defaults to Unspecified and remains Unspecified until the value is either calculated or manually entered.
- The dose/kg value is reset to Unspecified if the drug amount units unit family is changed to Drug A, B, C, or D.

21.6.2.7 Infusion Rate Requirements

- The infusion rate can either be entered manually or calculated.
- The drug calculation software checks for invalid or out of range entries for manually entered values.
- The drug calculation software calculates the infusion rate provided all of the following information is available: drug name, patient weight (if chosen drug is weight-based), drug amount, solution volume, and dosage.
- When calculating the infusion rate, the drug calculation software checks for overflow and underflow and displays it as invalid data in either of these cases.
- The infusion rate defaults to Unspecified.
- If the drug amount units unit family changes when the drug name selected is Drug A, B, C, or D, then the infusion rate changes to Unspecified.

21.6.2.8 Concentration Requirements

- The unit of measure for concentration will be one of the following depending on the selected drug dose units: mcg/ml, mg/ml, g/ml, units/ml, or mU/mL.
- The drug calculation software computes the calculation value provided all of the following information is available: drug name, drug amount, and solution volume.
- The concentration value is automatically recalculated if the drug amount or solution volume is changed.
- When computing the calculation value, the drug calculation software checks for overflow and underflow and displays it as invalid data in either of these cases.
- The concentration value defaults to blank.
- If the drug amount units unit family changes when the drug name selected is Drug A, B, C, or D, then the concentration value is blank.

21.6.3 Previous Drug Calculations

Previous drug calculations are stored in the calculator and can be viewed in the calculator and the titration table.

- Up to five previous calculations are stored in the drug calculator list.
- The drug calculation list includes the generic drug name, trade drug name, date of the last calculation for the drug, and time of the last calculation for the drug.
- A blue cursor highlights the current drug in the Previous Calculations list.
- If a drug calculation from the Previous Calculations list is edited, the timestamp and date is updated.
- If a calculation for a new drug occurs when the Previous Calculations list is full, the oldest calculation from the list is automatically removed to accommodate the newer calculation.
- When the cursor is moved through the Previous Calculations list while viewing the Titration table, the titration table updates to the selected drug in the list.

21.6.4 Deleting a Drug from the Previous Calculations List

1. Select the **Tools** tab from the Navigation Area.
2. Select the **Calculators** button.
3. Select the **Drug** button.
4. Use the arrow buttons in the Previous Calculations list to highlight the drug.
5. Select the **Delete selected** button.
The drug is deleted from the Previous Calculations list.

21.6.5 Navigating to the Drug Titration Table

1. Select the **Tools** tab from the Navigation Area.
2. Select the **Calculators** button.
3. Select the **Drug** button.
4. Select the **Titration Table** tab (as shown in FIGURE 21-3).

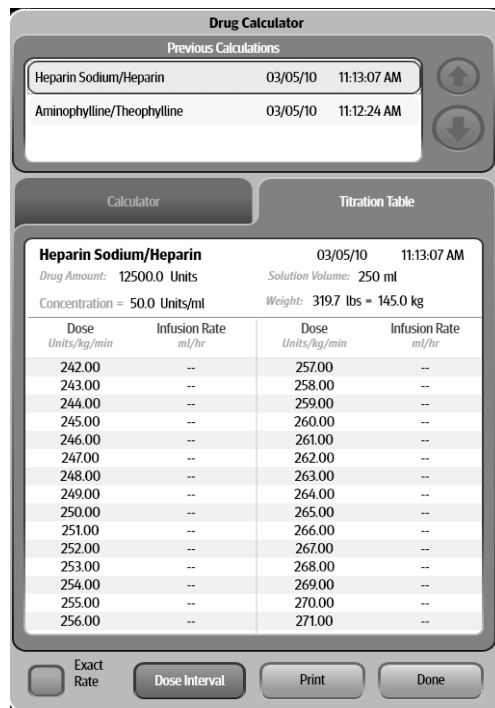

FIGURE 21-3 Example Titration Table

5. Select a drug from the Previous Calculations list.

6. Select the buttons described in TABLE 21-5 to configure the tab.

TABLE 21-5

BUTTON	DESCRIPTION / COMMENTS	CHOICES*
Dose Interval	Use to configure the increments by which the entries in the table dosages are varied.	1, 5, 10, 25, 50, 100, 0.01, 0.05, 0.1, 0.125, 0.2, 0.25, 0.5 Default dose interval value is dependent on the selected drug specified in TABLE 21-3.
Exact Rate	This check box displays the infusion rates as exact numbers or whole numbers. When selected, the infusion rates display as exact numbers.	On, Off

7. Select the **Done** button.

21.6.5.1 Titration Table Requirements

- The titration table entries pair the dose and the infusion rate.
- The dose and the infusion rate pair that was last entered displays in the 15th position of the table whenever possible so that all dosages in the table are greater than zero.
- For each drug, the table may contain up to 30 entries.
- When the titration table dose interval is 0.125, the precision is 0.001.
- The titration table infusion rate values are rounded to the nearest whole number when the infusion rate is configured to use whole numbers.
- The titration table displays the following header information: drug name (generic and trade name), patient weight in lbs or kg (if drug is weight-based), drug amount and drug units, solution volume and solution volume units, concentration and concentration units.
- The titration table displays a blank field for patient weight when the drug is not weight-based.

21.7 Drug Calculations Report

Refer to "Drug Calculations Report" on page 19-37 for additional information.

21.8 Drug Calculator Troubleshooting

MESSAGE/PROBLEM	REASON	SOLUTION
Drug calculations does not display in Previous Calculations list.	Drug is not in viewable area of list.	Use the arrow buttons to scroll up and down to find the drug.
Previous Calculations list arrow button are disabled.	All the drug calculations are already shown in the list.	N/A
No Previous Calculations	Either all the drug calculations were deleted from the calculator or no drug calculations exist for the patient.	If needed, create a drug calculation.
The Delete selected button is disabled	There are no drugs in the Previous Calculations list to delete.	N/A
The Print button is disabled in the Titration table tab	There are no drug calculations.	N/A

This page intentionally left blank.

Alarm Watch

Alarm Watch	22-2
Alarm Watch Tile	22-6
Alarm Watch Notification.....	22-6
Alarm Watch Troubleshooting	22-8

22.1 Alarm Watch

The Alarm Watch feature enables a V Series monitor (defined as the Host monitor) to be notified of an alarm condition and observe specified parameters for another networked V Series monitor (defined as the Source monitor) from a remote location. To view the locations or beds, configure the alarm watch tile (shown as A-W) to display on the Host monitor. Up to 16 beds can be viewed from the Host monitor.

During the initial setup and configuration of the Host monitor, the System Administrator configures the default alarm watch locations. During this setup process, the administrator has to decide which default locations and alarms the Host monitor will watch. These decisions are usually based on staffing and/or departmental needs. Once the locations are configured for the Host monitor, they become the default watched locations for that monitor and will continue to be watched until the System Administrator changes them.

Once the A-W tile is configured to display at the Host monitor, the default locations populate the A-W tile. The  icon beside a bed indicates that it was added by the System Administrator.

NOTE: Refer to "Configuring the Alarm Watch Tab" on page 25-14 for additional information.

Additional locations may also be watched but do not have to be setup by the System Administrator. These locations are usually for short-term observation and are not saved as part of the departmental defaults. This chapter describes how to configure these types of locations.

Display Setup

To see all the currently monitored beds, alarm watch must be configured to display on the Main Screen. Refer to "Display Options Dialog" on page 3-2 for additional information.

NOTE: The V 12/V 21 also provides a visual notification when a bed is in alarm even if the tile is not configured to display. Refer to "Alarm Watch Notification" on page 22-6 for additional information.

22.1.1 Navigating to the Alarm Watch Setup Dialog

- Select the A-W tile.

OR





- Select the **Tools** tab, then select the **Alarm Watch** button.
The Alarm Watch Setup dialog displays (as shown in FIGURE 22-1).

NOTE: The beds listed in the Alarm Watch Setup dialog include all the currently monitored beds.



FIGURE 22-1 Example Alarm Watch Setup Dialog

22.1.2 Alarm Watch Bed Status Symbols

SYMBOL	DESCRIPTION
	Indicates that the location is active on the V Series central network.
	Indicates that the location is currently inactive on the V Series central network.
	Indicates that the location is locked. Locked locations are setup by the System Administrator in the System Alarm Watch tab and require a password to modify or remove.
NOTE:	The locked symbol may be combined with the inactive and/or active symbol. For example, this symbol  indicates the location is active and locked.

22.1.3 Adding a Bed

NOTE: The beds added from this dialog must be on the V Series central network. Beds added in this dialog are not saved to the default System Alarm Watch locations. Refer to "Adding an Alarm Watch Location" on page 25-14 for additional information.

1. Select the A-W tile.
The Alarm Watch Setup dialog displays.
2. Select an available position in the Alarm Watch Setup grid.

3. Select the **Add Bed** button, then select a bed from the list box.
The bed displays in the Alarm Watch Setup grid.

NOTE: Only locations where room/bed information was entered are available in the list.

NOTE: The beds are listed alphabetically in the list box.

NOTE: One Host monitor can watch a maximum of 16 beds.

4. Select the **Cancel** or **Accept** button.
 - The **Cancel** button closes the dialog without saving the settings.
 - The **Accept** button saves the settings and closes the dialog.

22.1.4 Removing a Bed

1. Select the A-W tile.
The Alarm Watch Setup dialog displays.
2. Select an **unlocked** bed in the Alarm Watch Setup grid.

NOTE: Locked beds (indicated by the  symbol) cannot be removed from the Alarm Watch Setup grid. Refer to "Removing Alarms from the Watched Alarms List" on page 22-5 for additional information.

3. Select the **Remove Bed** button.
4. Select the **Cancel** or **Accept** button.
 - The **Cancel** button closes the dialog without saving the settings.
 - The **Accept** button saves the settings and closes the dialog.

22.1.5 Adding Alarms to Watched Alarm List

NOTE: Alarms added in this dialog are not saved to the default System Alarm Watch locations.

1. Select the A-W tile.
The Alarm Watch Setup dialog displays.
2. Select a bed in the Alarm Watch Setup grid.
3. Select the **Alarms** button.
4. Select an alarm from the Choices list (left side of dialog), then select the **Add** button.
The alarm moves to the Watched Alarms list (right side of dialog).
5. Continue to select the **Cancel** or **Accept** button to return to the Main display.
 - The **Cancel** button closes the dialog without saving the settings.
 - The **Accept** button saves the settings and closes the dialog.

22.1.6 Removing Alarms from the Watched Alarms List

1. Select the A-W tile.
The Alarm Watch Setup dialog displays.
2. Select a bed in the Alarm Watch Setup grid.
3. Select the **Alarms** button.
4. Select an **unlocked** alarm from the Watched Alarm list (right side of dialog), then select the **Remove** button.
The alarm is moved back to the Choices list (left side of dialog).

NOTE: **Locked alarms (indicated by the  symbol) cannot be removed from the Watched Alarm list. Refer to "Removing an Alarm Watch Location" on page 25-15 for additional information.**

5. Continue to select the **Cancel** or **Accept** button to return to the Main display.
 - The **Cancel** button closes the dialog without saving the settings.
 - The **Accept** button saves the settings and closes the dialog.

22.2 Alarm Watch Tile

The Alarm Watch tile displays:

1. Tile name
2. Locked bed
3. Active, unlocked bed

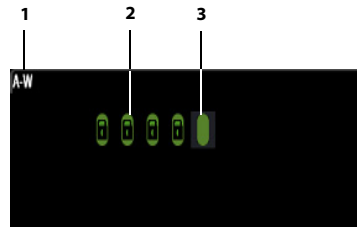

FIGURE 22-2 Example Alarm Watch Tile (No Beds in Alarm)

22.3 Alarm Watch Notification

When a watched bed is in alarm, it is either displayed in the A-W tile or displayed somewhere on the Main Screen (as shown in FIGURE 22-5). Both types of alarm notifications display the alarm type, flash in the corresponding alarm priority color, and indicate the alarms location. The **V 12/V 21** displays the three highest priority most recent alarms for the currently monitored beds. When there are more than three active alarms for the currently monitored beds, the **Show All** (as shown in FIGURE 22-4) button displays in the tile indicating that there are more than three beds in alarm.

NOTE: If the Host monitor is in the Privacy Mode and a watched bed goes into alarm, the Privacy Mode indicator/alarm light settings of the Host monitor are observed. Refer to "Privacy Mode" on page 3-15 for additional information.

NOTE: If the C.O. Run, PAWP, PA Insertion, Hemo Calculations, Drug Calculations, or VAccess dialogs is open when a watched bed goes into alarm, all alarm watch notifications are disabled and the message "Incoming Alarms Blocked" displays in the A-W tile message area.

A-W Tile Configured



FIGURE 22-3 Example Alarm Watch Tile (One (1) Bed in Alarm)



FIGURE 22-4 Example Alarm Watch Tile (Three (3) or More Beds in Alarm)

A-W Tile Not-Configured

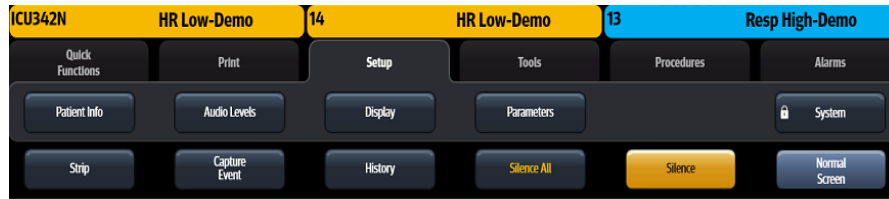

FIGURE 22-5 Example Alarm Watch Notification Strip (Three alarms)

22.3.1 Acknowledging Watched Alarms

To acknowledge a single alarm (where the **Show All** button is not present):

- Select the A-W tile or the Alarm Watch Notification **Strip** (as shown in FIGURE 22-5). This opens the Remote View dialog and silences all the active alarms for the bed.

NOTE: Refer to the Remote View chapter for additional information.

To acknowledge an alarm where the **Show All** button is present:

1. Select the **Show All** button. The Alarm Watch Overview dialog (shown in FIGURE 22-6) displays.
2. Select the **Silence All** button to acknowledge all the alarms at the Host monitor for the monitored beds or wait for the dialog to time-out.

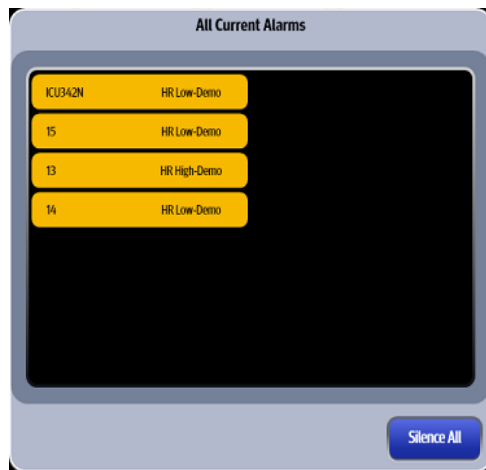

FIGURE 22-6 Example All Current Alarms Dialog

NOTE: The Alarm Watch Overview dialog displays the highest priority most recent alarms for the currently monitored beds.

22.4 Alarm Watch Troubleshooting

The A-W tile area displays messages indicating the current state of the alarm watch beds. If there is more than one message to display, the messages scroll.

MESSAGE/ISSUE	REASON	SOLUTION
Do not see the A-W tile in display.	Tile not configured to display.	Refer to "Display Options Dialog" on page 3-2 for additional information.
Cannot remove bed from Alarm Watch Setup dialog.	Bed is locked and can only be removed by the System Administrator.	Refer to "Removing a Bed" on page 22-4. If the bed is locked, contact the System Administrator.
See bed at the central station but do not see in Alarm Watch Setup dialog.	Only locations where room/bed information was entered are available in the list.	Add a room/bed to the location.
Incoming Alarms Blocked	One of the following dialogs is open at the Host monitor: C.O. Run, PAWP, PA Insertion, Hemo Calculations, Drug Calculations, or VAccess.	Close the dialogs at the Host monitor to unblock alarm watching.
Cannot add any more beds.	The V 12/V 21 can only watch up to 16 beds.	No solution needed.
The system is only watching lethal alarms.	Only lethal alarms are included in the Watched Alarms list.	Refer to "Adding Alarms to Watched Alarm List" on page 22-4.
AW Comm Lost	Displays when the A-W tile is not configured for display and there is a communications loss with the Source monitor.	Contact the System Administrator.

* *Display messages are shown in bold text.*

23.0

Remote View

Remote View.....	23-2
Remote View Troubleshooting	23-6

23.1 Remote View

The Remote View feature allows the simultaneous display of data from two patients on a single monitor. The monitor where the data originates is defined as the Source monitor. The monitor at the distant location is defined as the Host monitor. When using Remote View, all of the parameters at the Host monitor are still seen but are compressed at the top portion of the display to allow room for the Remote View dialog (as shown in FIGURE 23-1).

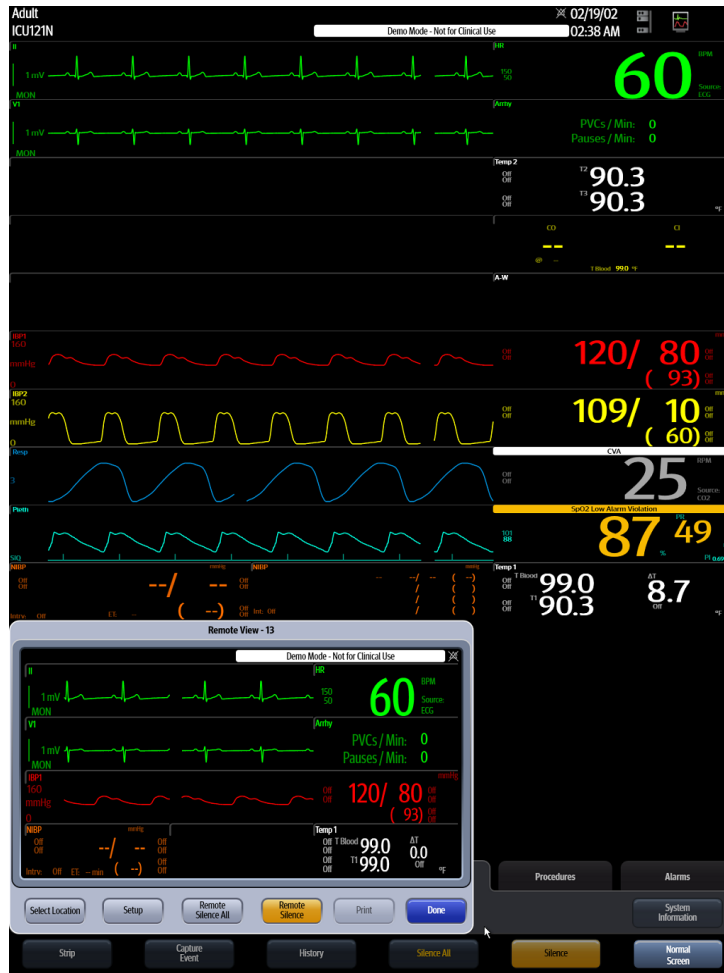

FIGURE 23-1 Example Remote View Dialog

23.1.1 Remote View Setup at the Host Monitor

1. Select the **Tools** tab, then select the **Remote View** button.
The Remote View dialog displays.
2. If the desired location is not already displayed in the Remote View dialog, choose the **Select Location** button, then select a location from the listbox.
The **Connecting...** message displays in the Remote View dialog until the connection to the selected remote location is established.

NOTE: The system automatically remembers and displays the last selected device in the Remote View dialog unless the Remote View feature is turned off.

3. Optional - select the **Select Location** button, then choose the **Off** button to stop viewing the remote view location.
4. Optional - select the **Done** button to close the Remote View dialog.

23.1.2 Configuring the Remote View Display Dialog

Customize the Remote View dialog to view the parameters and waveforms which are especially useful in managing a patient remotely. The Remote View dialog displays the parameters and waveforms, including the waveform speed, size, and color based on the configuration settings at the Source monitor, unless they are customized at the Host monitor to display differently.

NOTE: Any customizations made in the Remote View dialog are only temporary. Once the dialog closes or the location is changed, the settings from the source location are reloaded.

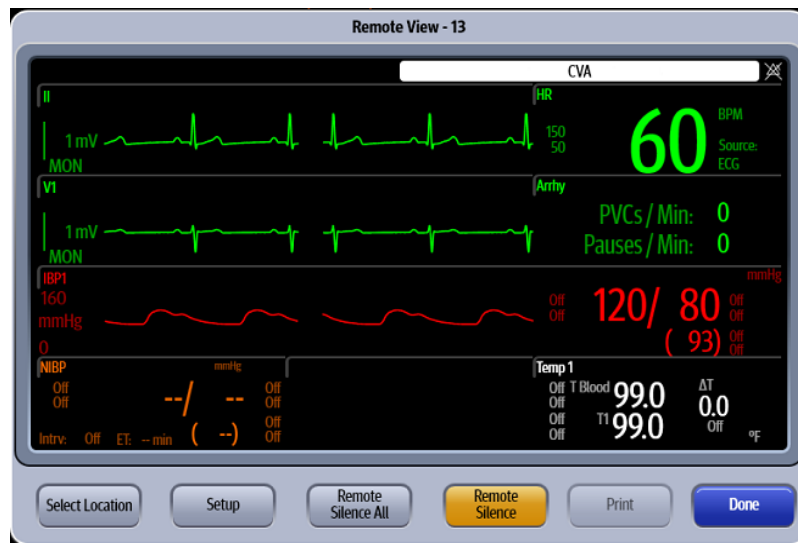

FIGURE 23-2 Example Remote View Dialog

1. Select the **Tools** tab, then select the **Remote View** button.
The Remote View dialog displays.
2. If the desired location is not already displayed in the Remote View dialog, choose the **Select Location** button, then select the desired location from the listbox.
Data from the selected location displays in the Remote View dialog.
3. Select the **Setup** button.
The Remote View Display Setup dialog displays.

- As the screen message indicates, select an area on the grid to see a list of available parameters. A list of digital or waveform parameters displays to the right of the grid (as shown in FIGURE 23-3).

NOTE: The Host monitor can display all data with the exception of the following: NIBP List tile, ST Beat tile, Time tile, overlapped IBP tiles, CCO tile, CCO STAT tile, SvO2 tile, Hemo tile, rSO2 tile and Gas tile.

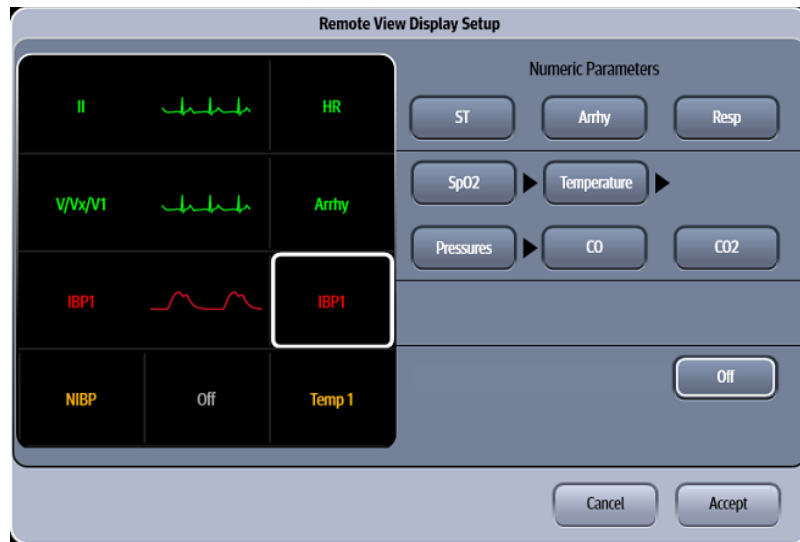



FIGURE 23-3 Example Remote View Display Setup Dialog

- Select a parameter button.

NOTE: The arrow beside a parameter button (for example, ) indicates that there is a submenu with additional choices available.

- Select a parameter from the list to add it to the grid.

OR

Select the **Off** button to leave that portion of the grid empty.

NOTE: The HR parameter tile and the topmost ECG waveform tile cannot be turned off.

- Select the **Cancel** or **Accept** button.
 - The **Cancel** button closes the dialog without saving the settings.
 - The **Accept** button saves the settings and closes the dialog.
- Optional - select the **Done** button to close the Remote View dialog.

23.1.3 Managing Alarm Delays from the Host Monitor

- The alarm audio enunciation delay at the Host monitor is dependent on the configuration settings at the Source monitor. Acknowledgement of alarms can only occur at the Source monitor. When an alarm is silenced from the Host monitor, the current silence state with a countdown of the audio resume time displays in the message area (which is above the HR) in the Remote View dialog and the Source monitor's message area.
- Manage alarm silencing by using the buttons described in TABLE 23-1.

TABLE 23-1

BUTTON	DESCRIPTION / COMMENTS
Remote Silence All	Temporarily silences all current and future alarms at the Source and Host monitor for two (2) minutes provided the Silence Source setting is turned On. If the Silence Source setting is turned Off, the silencing of alarms only occurs at the Host monitor.
Remote Silence	Temporarily silences all current alarms at the Source and Host monitor for two (2) minutes provided the Silence Source setting is turned On. If the Silence Source setting is turned Off, the silencing of alarms only occurs at the Host monitor.
NOTE: Refer to "Configuring the System Tab" on page 25-16 for additional information.	

23.1.4 Printing from the Remote View Dialog

Select the **Print** button to print the Waveform Report from the Remote View dialog.

NOTE: The settings and the data are derived from the Source monitor even though it is being printed from the Host monitor.

NOTE: Refer to the "Waveform Report" on page 19-9 for additional information.

23.2 Remote View Troubleshooting

MESSAGE/PROBLEM	REASON	SOLUTION
Source monitor is not silencing when Remote Silence or Remote Silence All is selected at Host monitor.	Silence Source is not turned On at the Source monitor.	Turn on Silence Source in the System tab. Refer to "Configuring the System Tab" on page 25-16 for additional information.
No waveforms print on the Waveform Report.	No waveforms were selected to print at the Source monitor.	Check the Configure Waveform settings at the Source monitor.
Desired location not available in the Remote View Location listbox.	There is an incompatible version of software installed at the Source monitor.	Have the software at the Source monitor upgraded.
The Connecting... message remains in the Remote View dialog after remote location is selected.	There is an incompatible version of software installed on the Source monitor.	Only use the Remote View feature with a monitor that has a compatible version of software. Refer to "System Information" on page 2-16 to determine which software versions are installed on the V 12/V 21 monitor.

* *Display messages are shown in bold text.*

24.0

VAccess

Introduction 24-2

24.1 Introduction

VAccess provides a mechanism to connect to a single remote computer directly from the **V 12** or **V 21** monitor while still viewing the patient's vital signs. One monitor can save a maximum of four VAccess connections.

NOTE: The **VAccess** button is only available in the **Tools** tab if it was enabled in **System Setup**. Refer to the **System Setup** chapter for additional information.

24.1.1 Navigating to the VAccess Dialog

1. Select the **Tools** button from the Navigation Area.
2. Select the **VAccess** button.
The VAccess dialog displays (as shown in FIGURE 24-1).



FIGURE 24-1 Example VAccess Dialog

24.1.2 Connecting to a VAccess Location

1. Select the **Tools** button from the Navigation Area.
2. Select the **VAccess** button.
3. Select the **Select Location** button, then select a location from the list.
Within a few moments, the remote desktop loads in the window.

NOTE: If there is no activity at the remote desktop, for example, no one has logged in to remote desktop, it automatically times out. The Remote Access Protocol (RDP) Administrator at the site configures this time out. If there is 10 minutes of inactivity once logged into the remote desktop, the VAccess application automatically times out. The 10 minute time out is controlled by the V Series application and is not user configurable.

4. Optional - to switch to a different connection, select the **Select Location** button again and choose a different location from the list.
5. When finished with connection, select the **Done** button.

System Setup

Introduction	25-2
System Dialog	25-2
Configuration Management.....	25-19

25.1 Introduction

The **V 12/V 21** System Setup dialog provides access to the system default settings such as date and time format, parameter timeouts, enabling/disabling lethal alarms, Quick Functions buttons, default printers, service mode, and password updates. Access to this dialog **requires** a password.

25.2 System Dialog

The **System** dialog, located in the Setup tab, (as shown in FIGURE 25-1) contains the following tabs:

- General
- Alarms
- Printer
- Network
- Alarm Watch
- System

A description of each tab follows.

25.2.1 Navigating to the System Dialog

1. Select the **Setup** tab from the Navigation Area.
2. Select the **System** button.

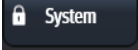
NOTE: The  locked icon in the **System** button indicates that a password is required to access the **System** dialog.

3. Enter the password.
4. Select the **Accept** button.
The System dialog displays (as shown in FIGURE 25-1).

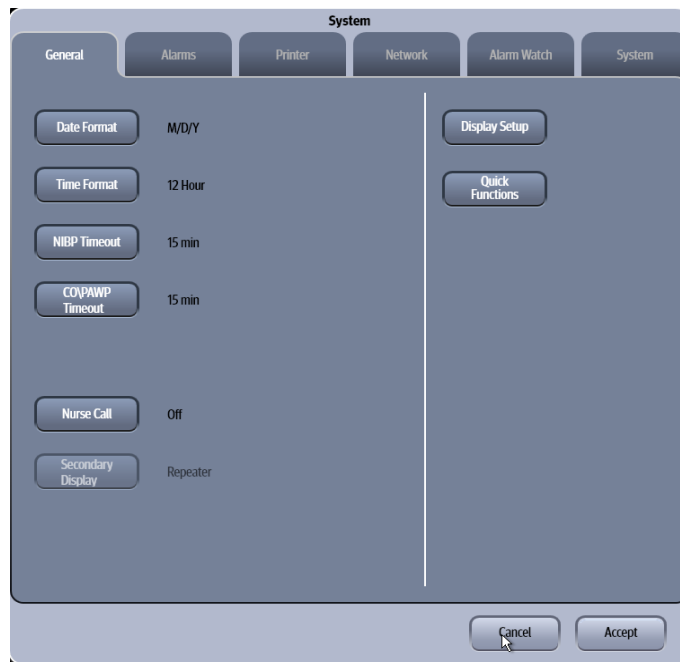

FIGURE 25-1 Example System Dialog (General Tab)

25.2.2 Configuring the General Tab

Select the **General** tab to configure the screen formats, timeouts, display setup, and Quick Functions buttons. These functions apply to all patient sizes.

1. Select the **Setup** tab from the Navigation Area.
2. Select the **System** button, enter the password, then select the **Accept** button.
3. Select the **General** tab (as shown in FIGURE 25-1).

NOTE: The current setting displays beside the tab button.

4. Select the buttons described in TABLE 25-1 to configure the tab.

TABLE 25-1

BUTTON	DESCRIPTION / COMMENTS	CHOICES*
Date Format	Changes the format in which dates are displayed in the system.	D/M/Y, Y/M/D, M/D/Y
Time Format	Changes the format in which time is displayed in the system.	12 Hour , 24 Hour
NIBP Timeout	Determines the time interval at which the NIBP measurement is automatically removed from the Main Display.	15 min , 30 min, 45 min, 1 hr
CO/PAWP Timeout	Determines the time interval at which the CO/PAWP measurement is automatically removed from the Main Display.	15 min , 30 min, 45 min, 1 hr
Nurse Call	Sends an electronic signal to the Nurse Call system when an alarm is active.	Off , One-Shot, Continuous

* The factory default configuration settings are in bold.

TABLE 25-1

BUTTON	DESCRIPTION / COMMENTS	CHOICES*
	NOTE: When Nurse Call is configured for Off, the Alarm Responses dialog does not display the Nurse Call column.	
Secondary Display	Configures the secondary display.	Repeater
	NOTE: This button is not configurable. Repeater is the only choice and cannot be changed.	
Display Setup	Enables the System Administrator to unlock or delete any defined display presets without having to enter a password.	N/A
Quick Functions	Configures the buttons in the Quick Functions tab in the Navigation Area.	Refer to "Configuring the Quick Functions Tab" on page 25-4 for additional information.

* *The factory default configuration settings are in bold.*

5. Select the **Cancel** or **Accept** button.
 - The **Cancel** button closes the dialog without saving the settings.
 - The **Accept** button saves the settings and closes the dialog.

25.2.3 Configuring the Quick Functions Tab

The Quick Functions tab may be configured to include six (6) predefined keys. These functions apply to all patient sizes.

To define the Quick Function Keys buttons:

1. Select the **Setup** tab from the Navigation Area.
2. Select the **System** button, enter the password, then select the **Accept** button. By default, the **General** tab selects.
3. Select the **Quick Functions** button. The Quick Function Keys dialog displays (as shown in FIGURE 25-2).

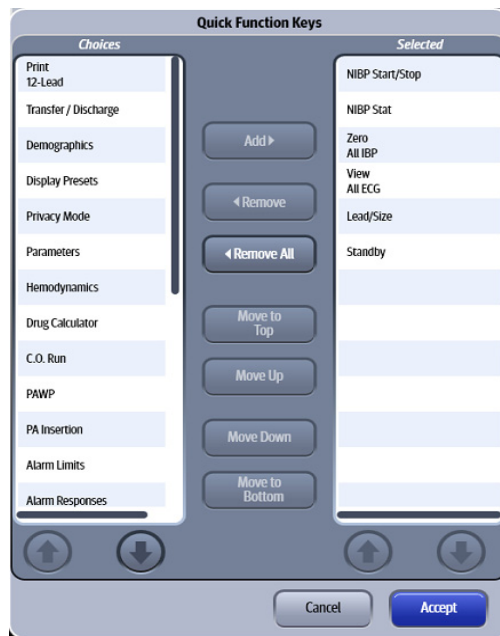

FIGURE 25-2 Example Quick Function Keys Dialog

4. Select from the available choices in the list box. listed

NOTE: The default selections are NIBP Start/Stop, NIBP Stat, Zero All IBP, View All ECG, Lead/Size, and Standby.

NOTE: The NIBP Start/Stop and NIBP Stat keys only display in the Navigation Area provided NIBP or NIBP List is configured to display in the Display Setup configuration.

NOTE: The order of the keys shown in the Quick Function row of the Navigation Area is dependent on how the keys are ordered in the Quick Function Keys dialog list box. For example, in FIGURE 25-2, the NIBP Start/Stop key is listed first and displays as the first button in the Quick Functions row.

5. Use the buttons described in TABLE 25-2 to navigate in this dialog.

TABLE 25-2

BUTTON	DESCRIPTION
Add	Adds the selected choice to the <i>Selected</i> list (located to the right of the navigation buttons).
Remove	Removes the selected choice from the <i>Selected</i> list.
Remove All	Removes all the choices from the <i>Selected</i> list and moves them back to the <i>Choices</i> list (located to the left of the navigation buttons).
Move to Top	Moves the highlighted choice to the top position in the <i>Selected</i> list.
Move Up	Moves the highlighted choice in the <i>Selected</i> list up one position.
Move Down	Moves the highlighted choice from the <i>Selected</i> list down one position.
Move to Bottom	Moves the highlighted choice to the bottom position in the <i>Selected</i> list.

6. Select the **Cancel** or **Accept** button.
 - The **Cancel** button closes the dialog without saving the settings.
 - The **Accept** button saves the settings and closes the dialog.

25.2.4 Configuring the Alarms Tab

Select the **Alarms** tab to configure the alarm silencing, lethal alarms, alarm delays, and other alarm related settings. Except for the Lethal Alarms, which apply to Adult and Pediatric patient sizes only, the other alarm settings apply to all patient sizes.

To configure the **Alarms** tab:

1. Select the **Setup** tab from the Navigation Area.
2. Select the **System** button, enter the password, then select the **Accept** button.
3. Select the **Alarms** tab.
The **Alarms** tab displays (as shown in FIGURE 25-3).

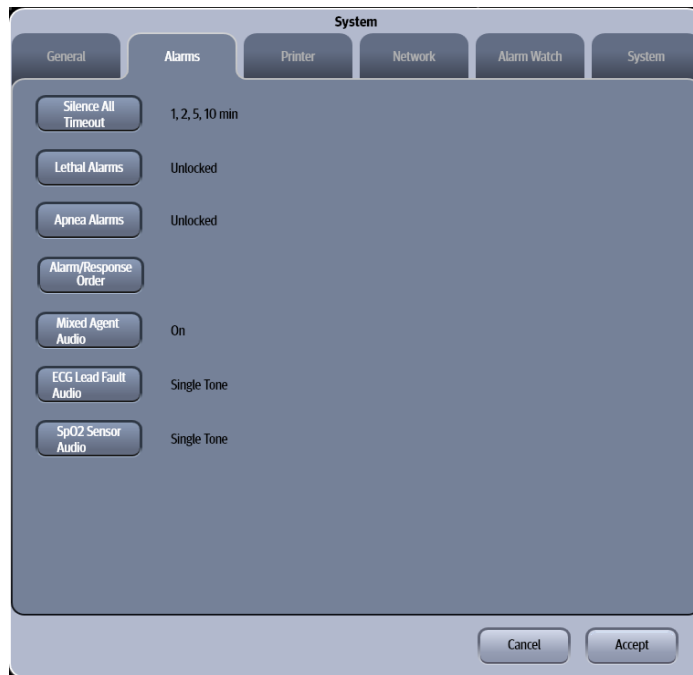

FIGURE 25-3 Example System Dialog (Alarms Tab)

4. Select the buttons described in TABLE 25-3 to configure the tab.

TABLE 25-3

BUTTON	DESCRIPTION / COMMENTS	CHOICES*
Silence All Timeout	Allows an authorized user to choose which settings are available in the Alarm Setup dialog Silence All functions. This setting controls for how long an alarm is muted.	France only: 1,2 min 1, 2, 5 min 1, 2, 5, 10 min Other countries: 1, 2, 5,10 min, Permanent 1, 2, 5, 10 min 1, 2, 5 min 1,2 min
NOTE: The Silence All configuration applies to all patient sizes.		
Lethal Alarms	Allows an authorized user to determine whether or not a user can modify the lethal arrhythmia settings and decide whether Asystole, VTach and VFib alarms can be turned off by the user.	Locked Unlocked
Apnea Alarms	Allows an authorized user to enable Apnea alarms at the monitor.	Locked Unlocked
Alarm/Response Order	Configures the order of the Alarm Limit dialog and Alarm Responses dialog tabs.	Refer to "Configuring the Alarm/Response Tab Order" on page 25-8.
Mixed Agent Audio	Allows an authorized user to enable or disable the Mixed Agent Audio.	On Off
NOTE: The Mixed Agent Audio configuration applies to all patient sizes.		
ECG Lead Fault Audio	Configures the audio alert when there is a lead fault which impacts HR or Arrhythmia.	Single Tone Five Tones Continuous
SpO2 Sensor Audio	Configures the audio alert when there is no SpO2 sensor, or the SpO2 Sensor off condition occurs.	Off Single Tone Five Tones Continuous

* The factory default configuration settings are in bold.

- Select the **Cancel** or **Accept** button.
 - The **Cancel** button closes the dialog without saving the settings.
 - The **Accept** button saves the settings and closes the dialog.

25.2.5 Configuring the Alarm/Response Tab Order

Define the order in which the tabs display in the Alarm Limits and Responses tab in the Alarm Limit/Response Tab Order dialog. The factory default alarm tab order is ECG/Resp, Pressure, Temp, Gases, CCO/Hemo, and Oximetry.

To configure the tab order:

1. Select the **Setup** tab from the Navigation Area.
2. Select the **System** button, enter the password, then select the **Accept** button.
3. Select the **Alarms** tab.
4. Select the **Alarm/Response Order** button.
The Alarm Limit/Response Tab Order dialog displays (as shown in FIGURE 25-4).



FIGURE 25-4 Example Alarm Limit/Response Tab Order

5. Use the buttons described in TABLE 25-4 to navigate in this dialog.

TABLE 25-4

BUTTON	DESCRIPTION
Move to Top	Moves the highlighted choice to the top position in the Selected list.
Move Up	Moves the choice in the Selected list up one position.
Move Down	Moves the choice from the Selected list down one position.
Move to Bottom	Moves the cursor up by one in the Selected list.

6. Select the **Cancel** or **Accept** button.
 - The **Cancel** button closes the dialog without saving the settings.

- The **Accept** button saves the settings and closes the dialog.

25.2.6 Configuring the Printer Tab

Select the **Printer** tab to configure up to one (1) laser printer. These functions apply to all patient sizes.

To configure the Printer tab:

1. Select the **Setup** tab from the Navigation Area.
2. Select the **System** button, enter the password, then select the **Accept** button.
3. Select the **Printer** tab.
The **Printer** tab displays (as shown in FIGURE 25-5).

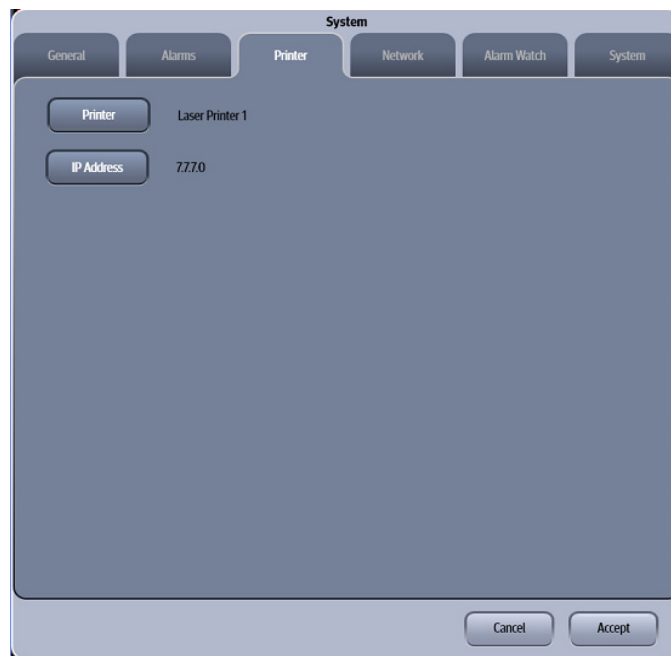

FIGURE 25-5 Example System Dialog (Printer Tab)

4. Select the buttons described in TABLE 25-5 to configure the tab.

TABLE 25-5

BUTTON/ CHECK BOX	DESCRIPTION / COMMENTS	CHOICES*
Printer	Allows an authorized user a means to specify a name for each laser printer. An example could be, department name, unit, or nurses station, etc.	Accepts up to 15 alphanumeric characters. Factory defaults to Laser Printer 1.
IP Address	Allows an authorized user to specify the laser printer IP address for each laser printer.	Accepts up to 15 digital characters. Factory default 7.7.7.0

* *The factory default configuration settings are in bold.*

5. Select the **Cancel** or **Accept** button.
 - The **Cancel** button closes the dialog without saving the settings.

- The **Accept** button saves the settings and closes the dialog.

25.2.7 Configuring the Network Tab

Select the **Network** tab to define the hospital name, department, indicate if the monitor will be networked to another monitor or to a central station, and establish VAccess connections. These functions apply to all patient sizes.

1. Select the **Setup** tab from the Navigation Area.
2. Select the **System** button, enter the password, then select the **Accept** button.
3. Select the **Network** tab.
The **Network** tab displays (as shown in FIGURE 25-6).

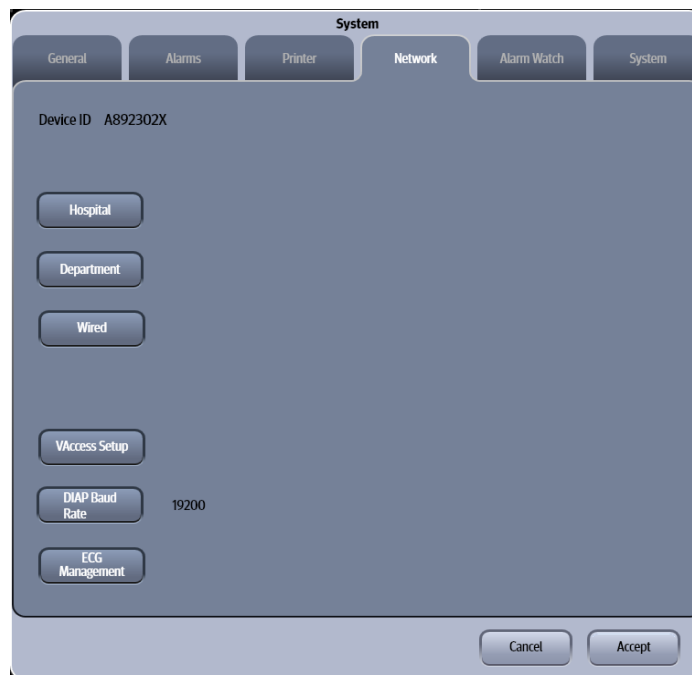

FIGURE 25-6 Example System Dialog (Network Tab)

4. Select the buttons described in TABLE 25-6 to configure the tab.

TABLE 25-6

BUTTON/ CHECK BOX	DESCRIPTION / COMMENTS	CHOICES*
Hospital	Provides clinician or biomedical engineer a means to specify the hospital name.	Accepts up to 15 alphanumeric characters. Factory defaults to blank.
Department	Provides clinician or biomedical engineer a means to specify the department name.	Accepts up to 15 digital characters. Factory defaults to blank.
Wired	Select to enter the IP Address and Subnet Mask.	Factory default IP address 7.6.6.0. Factory default Subnet Mask is 255.0.0.0.

* *The factory default configuration settings are in bold.*

TABLE 25-6

BUTTON/ CHECK BOX	DESCRIPTION / COMMENTS	CHOICES*
	NOTE: When the IP address of wired network is changed, restart the V 12/ V21 to take the changed IP address into effect.	
VAccess	Select to enable access to a maximum of four remote computers.	Refer to "Configuring VAccess" on page 25-12 for additional information.
DIAP Baud Rate	Select to change the DIAP baud rate of transfer.	9600, 19200
	NOTE: When using DIAP, the VDI module mode must be configured to DIAP. Refer to "Changing VDI Modes" on page 5-4 for additional information.	
	NOTE: Refer to the DIAP Communications Protocol Service Manual (P/N 0070-00-0307) for additional information.	
ECG Management	Select to access the ECG Management Setup dialog.	N/A
	NOTE: Refer to "Configuring ECG Management Setup" on page 25-13 for additional information.	

* The factory default configuration settings are in bold.

5. Select the **Cancel** or **Accept** button.
 - The **Cancel** button closes the dialog without saving the settings.
 - The **Accept** button saves the settings and closes the dialog.

25.2.8 Configuring VAccess

1. Select the **Setup** tab from the Navigation Area.
2. Select the **System** button, enter the password, then select the **Accept** button.
3. Select the **Network** tab, then select the **VAccess Setup** button.
The VAccess Setup dialog displays (as shown in FIGURE 25-7).

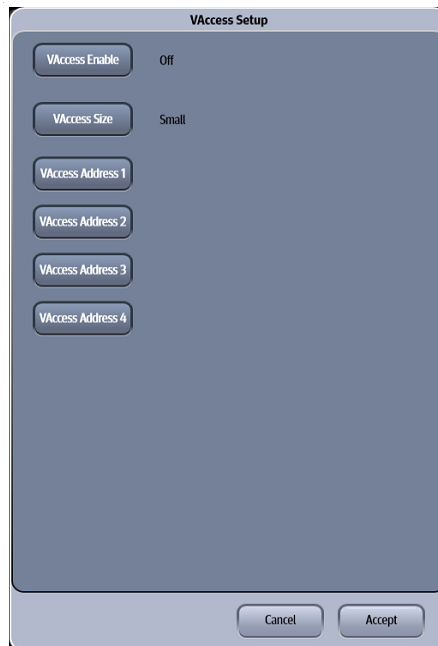

FIGURE 25-7 Example VAccess Setup Dialog

4. Select the buttons described in TABLE 25-7 to configure the tab.

TABLE 25-7

BUTTON/ CHECK BOX	DESCRIPTION / COMMENTS	CHOICES*
VAccess Enable	Provides clinician or biomedical engineer a means to specify if the VAccess button is visible in Tools menu.	Off , Primary
VAccess Size	Provides clinician or biomedical engineer a means to specify the size of the VAccess window.	Small , Large
VAccess Address 1- 4	Provides clinician or biomedical engineer a means to specify the IP address for up to four remote computers.	The default is blank.
NOTE: Enter the VAccess IP address in a x.x.x.x (where x represents the number) format.		

* The factory default configuration settings are in bold.

5. Select the **Cancel** or **Accept** button.
 - The **Cancel** button closes the dialog without saving the settings.
 - The **Accept** button saves the settings and closes the dialog.

25.2.9 Entering VAccess Addresses

Up to four (4) VAccess IP addresses may be entered into the system.

1. Select the **Setup** tab from the Navigation Area.
2. Select the **System** button, enter the password, then select the **Accept** button.
3. Select the **Network** tab, then select the **VAccess Setup** button.
4. Select one (four buttons are available) of the VAccess Address buttons.
A keyboard dialog displays.
5. Enter the IP address in a **x.x.x.x** (where x represents the number) format, then select the **Accept** button to close the keyboard dialog.
6. Select the **Cancel** or **Accept** button.
 - The **Cancel** button closes the dialog without saving the settings.
 - The **Accept** button saves the settings and closes the dialog.

25.2.10 Configuring ECG Management Setup

When the 12 Lead Interpretation report is being printed, the 12 Lead interpretation as XML format is exported to the specified file path. ECG Management allows an authorized user to enable ECG Management and configure the file path (as shown in FIGURE 25-8).

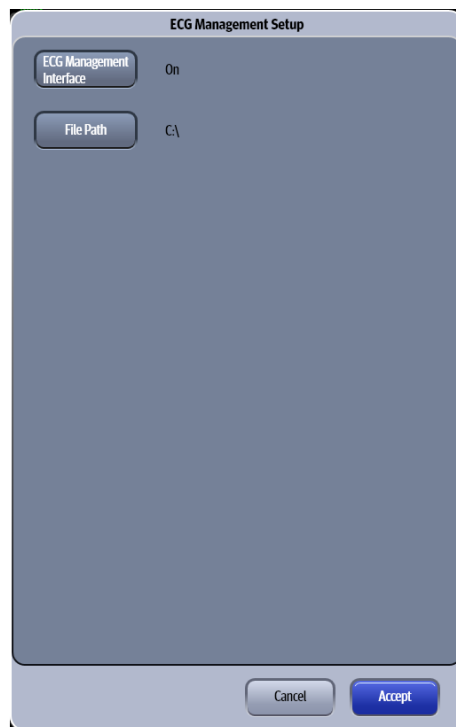

FIGURE 25-8 Example ECG Management Setup

1. Select the **Setup** tab from the Navigation Area.
2. Select the **System** button, enter the password, then select the **Accept** button.
3. Select the **Network** tab, then select the **ECG Management** button (as shown in FIGURE 25-8).
4. Select the buttons described in TABLE 25-8 to configure the tab.

TABLE 25-8

BUTTON	DESCRIPTION / COMMENTS	CHOICES*
ECG Management Interface	Provides ECG Management Interface choices.	Off On
File Path	Select to enter a specified file path to export the 12 Lead Interpretation in an XML format.	None

* The factory default configuration settings are in bold.

25.2.11 Configuring the Alarm Watch Tab

The Alarm Watch feature allows the simultaneous viewing of selected alarms for up to 16 beds from a single monitor. The System Administrator can add different locations for each monitor to watch based on the staffing and/or departmental needs. Default alarm watch locations are managed through the password protected System Alarm Watch tab. All configured locations are automatically included in the monitor's list of watched beds. **Any changes made (including the initial configuration) to the System Alarm Watch settings do not take effect until the patient is either discharged or the patient size is changed.** Any active location on the V Series central network can be added to the watched list.

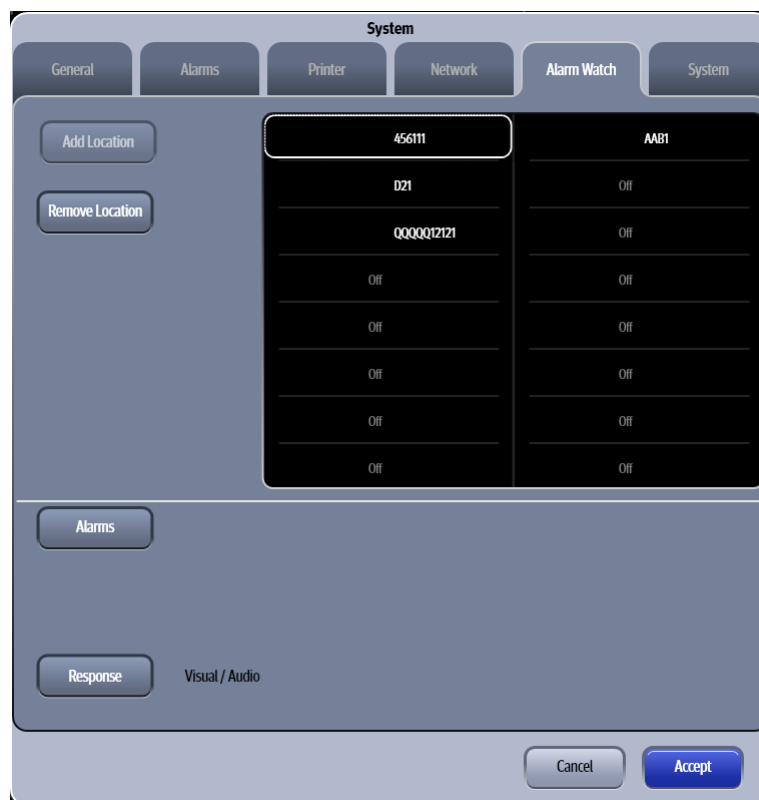

FIGURE 25-9 Example System Setup (Alarm Watch Tab)

25.2.12 Adding an Alarm Watch Location

1. Select the **Setup** tab from the Navigation Area.
2. Select the **System** button, enter the password, then select the **Accept** button.

3. Select the **Alarm Watch** tab.
4. Select the **Add Location** button, then select a location from the list.
The location displays in the Alarm Watch grid.

NOTE: Only locations where room/bed information was entered are available in the list.

NOTE: Once a location is added to the list, it remains on the list until it is removed. The locations are listed alphabetically in the list box.

5. Select the **Cancel** or **Accept** button.
 - The **Cancel** button closes the dialog without saving the settings.
 - The **Accept** button saves the settings and closes the dialog.

25.2.13 Removing an Alarm Watch Location

NOTE: Removing alarms from a System alarm watch location affects all the watched beds.

1. Select the **Setup** tab from the Navigation Area.
2. Select the **System** button, enter the password, then select the **Accept** button.
3. Select the **Alarm Watch** tab.
4. Select a location from the alarm watch grid.
5. Select the **Remove Location** button.

25.2.14 Adding Alarms to a Watched Alarm List

NOTE: Adding alarms from a System alarm watch location affects all the watched beds.

1. Select the **Setup** tab from the Navigation Area.
2. Select the **System** button, enter the password, then select the **Accept** button.
3. Select the **Alarm Watch** tab.
4. Select the **Alarms** button.

NOTE: Asystole, V-Fibrillation, and V-Tachycardia are automatically included in the watched alarms list. They are indicated by the locked  icon (meaning they cannot be removed from the list).

5. Select an alarm from the Choices list (left side of dialog), then select the **Add** button.
The alarm moves to the Watched Alarms list (right side of dialog).
6. Continue to select the **Cancel** or **Accept** button to return to the Main display.
 - The **Cancel** button closes the dialog without saving the settings.
 - The **Accept** button saves the settings and closes the dialog.

25.2.15 Removing Alarms from the Watch Alarm List

1. Select the **Setup** tab from the Navigation Area.
2. Select the **System** button, enter the password, then select the **Accept** button.
3. Select the **Alarm Watch** tab.

4. Select the **Alarms** button.
5. Select an **unlocked** alarm from the Watched Alarms list (right side of dialog), then select the **Remove** button.
The alarm moves to the Choice list (left side of dialog).

NOTE: **Asystole, V-Fibrillation, and V-Tachycardia are automatically included in the watched alarms list. They are indicated by the locked  icon (meaning they cannot be removed from the list).**

6. Continue to select the **Cancel** or **Accept** button to return to the Main display.
 - The **Cancel** button closes the dialog without saving the settings.
 - The **Accept** button saves the settings and closes the dialog.

25.2.16 Alarm Watch Response

The Alarm Watch Response is Visual/Audio. This setting indicates that when a configured alarm occurs, a visual indication displays and an audio alarm enunciates.

25.2.17 Configuring the System Tab

Select the **System** tab to configure the demo mode and service settings. These functions apply to all patient sizes.

To configure the **System** tab:

1. Select the **Setup** tab from the Navigation Area.
2. Select the **System** button, enter the password, then select the **Accept** button.
3. Select the **System** tab.
The **System** tab displays (as shown in FIGURE 25-10).

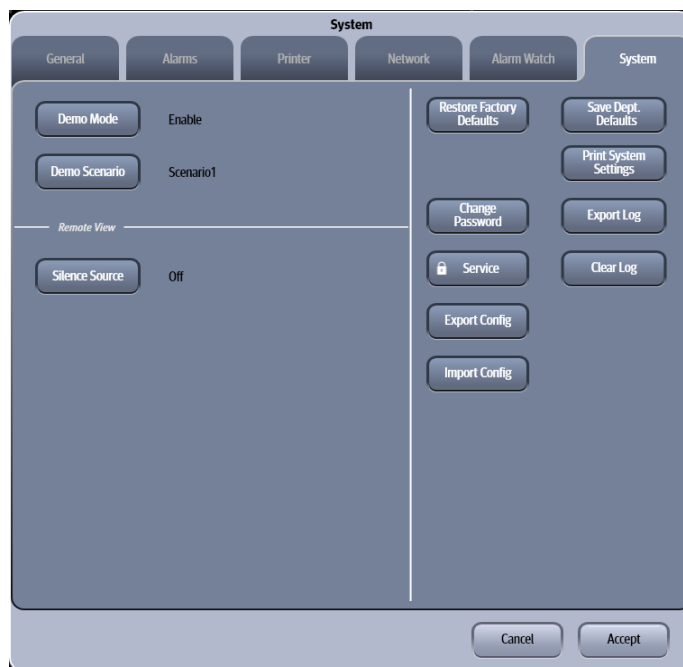

FIGURE 25-10 Example System Dialog (System Tab)

4. Select the buttons described in TABLE 25-9 to configure the tab.

TABLE 25-9

BUTTON/ CHECK BOX	DESCRIPTION / COMMENTS	CHOICES*
Demo Mode	Allows an authorized user to choose a demonstration mode for in-servicing staff or testing product features.	Enable, Disable
Demo Scenario	Allows an authorized user various demonstration scenarios that are intended to non-clinical conditions.	List all scenarios contained in the Scenarios folder.
Silence Source	This checkbox is related to the Remote View feature. When enabled, allows the alarms at the source location to be silenced by selecting a button from the remote location.	On, Off
Restore Factory Defaults	Allows an authorized user to reestablish the original database power up settings to factory default values.	N/A
NOTE: Refer to "Restore Factory Defaults" on page 25-17 for a list of exceptions.		
Change Password	Allows an authorized user to change the System password.	N/A
Service	Allows an authorized user access to the password protected Service Diagnostic mode.	N/A
Export Config	Copies the current settings to the external drive.	N/A
Import Config	Copies the settings from the external drive to the V 12/V 21 unit.	N/A
Save Dept. Defaults	Allows an authorized user to save the current monitor settings for the selected patient size.	N/A
Print System Settings	Prints all the system settings by patient size.	N/A
Export Log	Exports the error logs to an external storage device.	N/A
Clear Log	Clears the application error logs.	N/A

* *The factory default configuration settings are in bold.*

5. Select the **Cancel** or **Accept** button.
- The **Cancel** button closes the dialog without saving the settings.
 - The **Accept** button saves the settings and closes the dialog.

25.2.17.1 Restore Factory Defaults

The following settings are not affected when the Restore Factory Defaults button is selected because they are tied to regional settings:

- Date
- Time
- Temperature
- Language
- Country

NOTE: A confirmation message displays prior to restoring the current database values to the factory default values.

25.2.17.2 Change Password

This changes the password to access the System dialog.

NOTE: To change the System password, the current System password is required.

1. Select the **Setup** tab from the Navigation Area.
2. Select the **System** button, enter the password, then select the **Accept** button.
3. Select the **System** tab, then select the **Change Password** button.
The Enter Password keyboard dialog displays.
4. Enter the current System password, then select the **Accept** button.
The Create Password keyboard dialog displays.
5. Enter a new password, then select the **Accept** button.
The Verify Password keyboard dialog displays.
6. Enter the new password again, then select the **Accept** button.
A confirmation box dialog displays.

25.2.17.3 Import/Export Configuration Settings

Monitor settings may be imported or exported to multiple units provided a storage device is available.

1. Select the **Setup** tab from the Navigation Area.
2. Select the **System** button, enter the password, then select the **Accept** button.
By default, the **General** tab selects.
3. Select the **System** tab.
4. Insert a storage device into one of the serial ports.

NOTE: Refer to "General Product Description" on page 1-2 for serial port locations.

5. Optional - select the **Save Dept. Defaults** button before selecting the **Export Config** button to save the current department defaults for the selected patient size. If they are not saved, the factory default settings are exported.
6. Select the **Export Config** or the **Import Config** button.
A message warning not to remove the storage device and a progress bar display.

NOTE: If the storage device is not found after the Export/Import Config button is selected, the message "Warning: Please insert a external storage device." displays.

7. The files copy to or from the unit.
The message "Transfer Complete" displays.

NOTE: Imported settings DO NOT effect the current patient. They take effect once the current patient is discharged and a new admission occurs.

25.2.17.4 Save Dept. Defaults

The following settings are not affected when the **Save Dept. Defaults** button is selected because the setting is intended to be temporary:

- Notch Filter
- ESU Filter
- ST Representative Beat Display
- ST Offset

NOTE: A confirmation message displays prior to saving the department default settings as the power up settings.

25.2.17.5 Print System Settings

Refer to "System Settings Report" on page 19-43 for additional information.

25.3 Configuration Management

If the monitor is inadvertently powered down (due to power failure or battery depletion), monitor settings are recovered as follows:

- Restarting the monitor within 60 seconds restores the latest user-settings.
- Restarting the monitor after 60 but before 120 seconds restores the settings by either the latest user-settings or the user-saved settings.
- Restarting the monitor after 120 seconds restores the user-saved configurations.

This page intentionally left blank.

Product Maintenance

Introduction	26-2
Care and Cleaning of Monitor, Modules and Racks.....	26-2
Care and Cleaning of SpO ₂ Sensors	26-3
Care and Cleaning of Reusable Temperature Probes.....	26-3
Care and Cleaning of Reusable Cuffs	26-4
Care and Cleaning of Lead ECG Cables and Wires	26-5
Battery Maintenance	26-5
Care of CO ₂ Module.....	26-6

26.1 Introduction

This section of the manual outlines routine monitor maintenance guidelines.

The **V 12/V 21** monitor is designed for stable operation over long periods of time. Under normal circumstances the monitor should not require technical maintenance beyond that described in this section. However, routine maintenance, calibration and safety checks are recommended at least once a year or more often as required by local statutory or hospital administration practice.

26.2 Care and Cleaning of Monitor, Modules and Racks

NOTE: **Only use the following approved cleaning solutions. The system may become inoperable or halted because of contamination or damage caused by use of unapproved cleaning solution.**

Clean with a lint-free cloth, moistened with warm water (40°C/104°F maximum) and soap, diluted in any of the approved cleaning solutions.

- 70% isopropyl alcohol
- 10% sodium hypochloride (bleach) solution
- Water
- Virkon
- Super Sani-cloth (0.5% Quaternary ammonium chloride and 55% Isopropyl alcohol)

Apply cleaning solution to the cloth, not directly onto the monitor. DO NOT apply large amounts of liquid. DO NOT use abrasive cleaning agents or organic solvents.

Clean any spillage of blood or solutions on the monitor as soon as possible. Dried blood is very difficult to remove. Use a lint-free absorbent towels for spill cleanups. Dampen the towel with one of the approved cleaning solutions to aid in cleaning.

To prevent scratches on the screen carefully brush dust and dirt particles with a soft sponge moistened with cleaning solution or a fine, soft-hair brush. DO NOT use abrasive cleaning materials such as acetone or trichloroethylene. Remove fingerprints and stains with a liquid lens cleaner and a soft cloth. DO NOT wipe a dry screen or use alcohol or solvents containing chlorinated hydrocarbon.

Take extra care when cleaning the monitor screen because it is more sensitive to rough cleaning methods than the housing. Do not permit any liquid to enter the monitor case and avoid pouring it on the monitor while cleaning. Do not allow water or cleaning solution to enter the measurement connectors. Wipe around, not over, connector sockets.

After cleaning, dry all areas except the monitor screen with an absorbent paper towel.

26.2.1 Monitor Sterilization

Sterilization is not recommended for this monitor, related products, accessories or supplies unless otherwise indicated in the Operating Instructions that accompany the accessories or supplies.

26.3 Care and Cleaning of SpO₂ Sensors

NOTE: Refer to the individual instruction sheets that are packaged with each sensor.

- Check sensors and cables daily for signs of damage. Replace as required.
- Clean reusable SpO₂ sensors before and after each new patient.
- Wipe the patient contact area using a soft cloth with mild soap and water solution or isopropyl alcohol. Hydrogen peroxide can be used to remove dried blood.
- Allow the sensor to completely dry before using.

CAUTION: When cleaning SpO₂ sensors, do not use excessive amounts of liquid. Wipe the sensor surface with a soft cloth, dampened with cleaning solution. Do not attempt to sterilize.

Cleaning and Re-use of a Nellcor[®] Sensor

Nellcor reusable SpO₂ sensors may be reattached to the same patient if the emitter and detector windows are clear and the adhesive still adheres to the skin. The adhesive can be partially rejuvenated by wiping with an alcohol wipe and allowing the sensor to thoroughly air dry prior to replacement on the patient.

Do not immerse any Oxisensor[®], OxiMax[®], Durasensor[®], Oxiband[®], or Duraform[®] oxygen transducers, the Nellcor[®] RS-10 or Max-Fast[®] oxygen transducers, or any Nellcor[®] adhesive in water or cleaning solution. Clean Durasensor[®], Oxiband[®], and Duraform[®] oxygen transducers, and the Nellcor[®] RS-10 or Max-Fast[®] oxygen transducers by wiping with a disinfectant such as a solution containing 70% alcohol. Do not sterilize by irradiation, steam, or ethylene oxide. Use a new Oxiband[®] adhesive wrap or FORM-A adhesive bandage for each patient. Do not re-sterilize Oxisensor[®] or OxiMax[®] oxygen transducers.

26.4 Care and Cleaning of Reusable Temperature Probes

NOTE: Refer to the individual instruction sheets that are packaged with each temperature probe for additional information.

- Check temperature probes and cables daily for signs of damage. Replace as required.
- Clean the probes before and after each new patient.
- Wipe the patient contact area using a soft cloth with mild soap and water solution or isopropyl alcohol.
- Allow the probe to completely dry before using.

26.5 Care and Cleaning of Reusable Cuffs

NOTE: Accuracy of cuff-pressure transducers/indicators is to be verified at intervals specified by the manufacturer.

26.5.1 Reusable Cuffs with Bladders

Take out the bladder before cleaning and disinfecting the cuff.

Cleaning

Hand or machine wash the cuff in warm water or with mild detergent. Clean the bladder with a damp cloth. Air dry the cuff thoroughly after washing.

NOTE: Machine washing may shorten the service life of the cuff.

Disinfection

Disinfect the cuff with a cloth dampened in 70% isopropanol or with ultraviolet. Also clean the bladder with ultraviolet.

NOTE: Prolonged use of disinfectant may cause discoloration of the cuff.

Replace the bladder after cleaning and disinfecting the cuff:

1. Place the bladder on the top of the cuff (as shown in FIGURE 26-1).
2. Roll the bladder lengthwise and insert it into the large opening (as shown in FIGURE 26-1).
3. Hold the hose and the cuff and shake the complete cuff until the bladder is in position.
4. Thread the hose from inside the cuff, and out through the small hole under the internal flap.

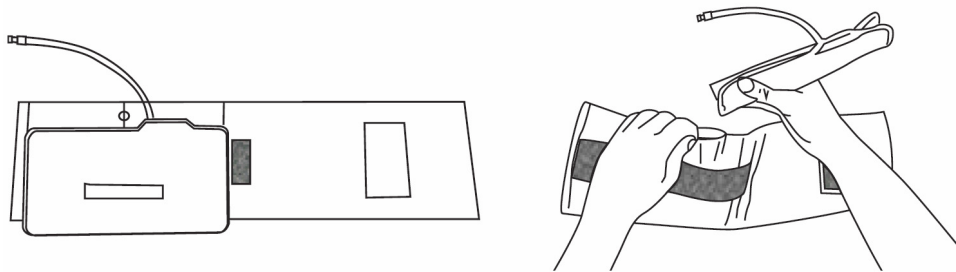

FIGURE 26-1 Example NIBP Cuff

CAUTION: Clean and disinfect the cuff according to the instructions.
Do not dry clean the cuff.
Do not press the cuff with a hot iron.
Do not clean with detergent or disinfectant.
Disinfect the bladder with 70% isopropanol or ultraviolet.

26.5.2 Reusable Bladderless Cuffs

Clean cuffs with warm water and a mild detergent. Do not use a detergent containing hand conditioners, softeners, or fragrances.

Antimicrobial Definition

Bladderless cuffs are treated with an antimicrobial coating. Antimicrobial technology effectively controls a broad spectrum of bacteria, fungi, algae and yeasts on a wide variety of treated substrates.

26.6 Care and Cleaning of Lead ECG Cables and Wires

Use the same approved cleaning solutions outlined in the "Care and Cleaning of Monitor, Modules and Racks" on page 26-2.

After cleaning, the ECG cables and lead wires should be wiped with water using a clean damp cloth then dried with a clean dry cloth. The ECG cables and lead wires must be allowed to dry thoroughly before use.

NOTE: ECG cables and lead wires must never be immersed, soaked in any fluids, and they should not be cleaned with harsh chemicals such as acetone or non-diluted bleach.

NOTE: Clean ECG cables carefully to avoid breaking internal wires by excessive bending, strain, or flexing.

NOTE: Do not autoclave, radiation or steam sterilize ECG cables or lead wires.

NOTE: Extended exposure to Ethylene Oxide gas may shorten life of the ECG cables and lead wires, leading to poor signal quality.

26.7 Battery Maintenance

Battery Replacement

1. Open battery compartment door, on left side of unit, by pressing the finger grip area and sliding the door to the rear.
2. Slide the release located at the top of the installed battery. This ejects the battery. Slide out and remove battery.
3. Slide in replacement battery until it clicks into place.
4. Close battery compartment door by sliding the door to the right until it firmly clicks into place.

CAUTION: Replace Li-Ion batteries with P/N 0146-00-0091-01 ONLY.

NOTE: Batteries using P/N 0146-00-0069 may fit inside the V 12 monitor but they will not properly report charging status.

The batteries may be subject to local regulations regarding disposal. At the end of the battery life, dispose of the batteries in accordance with any local regulations.

NOTE: V 12 batteries may only be charged within a V 12 monitor. Do not attempt to use commercial rechargers.

Li-Ion

Storage of the Li-Ion batteries depends on temperature, time period and the degree of cell charging state. After 6 months of storage at 23°C, fully charged Li-Ion batteries have a retention capacity of 93%.

Battery Maintenance

The batteries may be subject to local regulations regarding disposal. At the end of the battery life, dispose of the batteries in accordance with any local regulations.

NOTE: **V 12 batteries may only be charged within a V 12 monitor. Do not attempt to use commercial rechargers.**

26.8 **Care of CO₂ Module**

Refer to "Carbon Dioxide (CO₂)" on page 28-41 for additional information.

Accessories

ECG	27-2
SpO2	27-4
NIBP	27-5
Temperature.....	27-6
IBP	27-7
CO2	27-7
CO	27-8
Miscellaneous Accessories.....	27-9
Mounts & Mounting Accessories	27-10
Networking Accessories	27-10
Manuals.....	27-10

27.1 ECG

27.1.1 ECG Electrodes

PART NUMBER	DESCRIPTION
0681-00-0100-02	Disposable pre-gelled ECG Electrodes (box of 60)
0681-00-0100-01	Disposable pre-gelled ECG Electrodes, 1 case of 600 (10 boxes of 60)
0683-00-0449-01	Dual Snap Electrodes (box of 200)
0681-00-0098-01	Radio Opaque, Neonatal Pre-wired, 3 Lead ECG Electrodes, AAMI, 18" (45.7 cm), box of 100 packs (each pack contains 3 electrodes)
0681-00-0098-02	Radio Translucent, Neonatal Pre-wired, 3 Lead ECG Electrodes, AAMI, 18" (45.7 cm), box of 100 Packs (each pack contains 3 electrodes)

27.1.2 ECG Cables

PART NUMBER	DESCRIPTION
0012-00-1745-01	ECG Cable, 3/5 lead, 10' (3.1 m)
0012-00-1745-02	ECG Cable, 3/5 lead, 20' (6.1 m)
0012-00-1745-03	ECG Cable, 3/5 lead, ESIS, 10' (3.1 m)
0012-00-1745-04	ECG Cable, 3/5 lead, ESIS, 20' (6.1 m)
040-000072-00	Neonatal ECG Patient Cable, 10' (3.1 m)
0012-00-1746-01	ECG Cable 6 Lead, 10'
0012-00-1746-02	ECG Cable 6 Lead, 20'
0012-00-1746-03	ECG Cable 6 lead, 10', ESIS
0012-00-1746-04	ECG Cable 6 lead, 20', ESIS
0998-00-1804-01	ECG Module 12 Lead (American Standard)
0998-00-1804-02	ECG Module 12 Lead (National Standard)

27.1.3 ECG Leadsets

PART NUMBER	DESCRIPTION
0012-00-1503-01	ECG Leadwires, 5 lead, Snap, 18" (45.7 cm), AAMI
0012-00-1503-02	ECG Leadwires, 5 lead, Snap, 24" (61.0 cm), AAMI
0012-00-1503-03	ECG Leadwires, 5 lead, Snap, 36" (101.6 cm), AAMI
0012-00-1503-10	ECG Leadwires, 5 lead, Snap, 18" (45.7 cm), IEC
0012-00-1503-11	ECG Leadwires, 5 lead, Snap, 24" (61.0 cm), IEC
0012-00-1503-12	ECG Leadwires, 5 lead, Snap, 36" (101.6 cm), IEC
0012-00-1503-04	ECG Leadwires, 3 lead, Snap, 18" (45.7 cm), AAMI
0012-00-1503-05	ECG Leadwires, 3 lead, Snap, 24" (61.0 cm), AAMI
0012-00-1503-06	ECG Leadwires, 3 lead, Snap, 36" (101.6 cm), AAMI
0012-00-1503-13	ECG Leadwires, 3 lead, Snap, 18" (45.7 cm), IEC
0012-00-1503-14	ECG Leadwires, 3 lead, Snap, 24" (61.0 cm), IEC
0012-00-1503-15	ECG Leadwires, 3 lead, Snap, 36" (101.6 cm), IEC

* *Not available for sale in the United States*

PART NUMBER	DESCRIPTION
0012-00-1514-01	ECG Leadwires, 5 lead, Pinch, 18" (45.7 cm), AAMI
0012-00-1514-02	ECG Leadwires, 5 lead, Pinch, 24" (61.0 cm), AAMI
0012-00-1514-03	ECG Leadwires, 5 lead, Pinch, 36" (101.6 cm), AAMI
0012-00-1514-10	ECG Leadwires, 5 lead, Pinch, 18" (45.7 cm), IEC
0012-00-1514-11	ECG Leadwires, 5 lead, Pinch, 24" (61.0 cm), IEC
0012-00-1514-12	ECG Leadwires, 5 lead, Pinch, 36" (101.6 cm), IEC
0012-00-1514-04	ECG Leadwires, 3 lead, Pinch, 18" (45.7 cm), AAMI
0012-00-1514-05	ECG Leadwires, 3 lead, Pinch, 24" (61.0 cm), AAMI
0012-00-1514-06	ECG Leadwires, 3 lead, Pinch, 36" (101.6 cm), AAMI
0012-00-1514-13	ECG Leadwires, 3 lead, Pinch, 18" (45.7 cm), IEC
0012-00-1514-14	ECG Leadwires, 3 lead, Pinch, 24" (61.0 cm), IEC
0012-00-1514-15	ECG Leadwires, 3 lead, Pinch, 36" (101.6 cm), IEC
0012-00-1816-02	ECG Leadwires, 6 lead, Pinch, 24" (61.0 cm), AAMI
0012-00-1816-03	ECG Leadwires, 6 lead, Pinch, 36" (101.6 cm), AAMI
0012-00-1816-12	ECG Leadwires, 6 lead, Pinch, 24" (61.0 cm), IEC
0012-00-1816-13	ECG Leadwires, 6 lead, Pinch, 36" (101.6 cm), IEC
0012-00-1773-02	ECG Leadwires, 6 lead, Snap, 24" (61.0 cm), AAMI
0012-00-1773-03	ECG Leadwires, 6 lead, Snap, 36" (101.6 cm), AAMI
0012-00-1773-12	ECG Leadwires, 6 lead, Snap, 24" (61.0 cm), IEC
0012-00-1773-13	ECG Leadwires, 6 lead, Snap, 36" (101.6 cm), IEC
0012-00-1818-02	5-lead extended leadset snap 24", AAMI
0012-00-1818-03	5-lead extended leadset snap 36", AAMI
0012-00-1818-11	5-lead extended leadset snap 24", IEC
0012-00-1818-12	5-lead extended leadset snap 36", IEC
0012-00-1820-02	5-lead extended leadset pinch 24", AAMI
0012-00-1820-03	5-lead extended leadset pinch 36", AAMI
0012-00-1820-11	5-lead extended leadset pinch 24", IEC
0012-00-1820-12	5-lead extended leadset pinch 36", IEC
0010-10-12304	Adult Electrode (Kendall, package of 10)*
9000-10-07469	Pediatric Electrode (3M, package of 50)*

* *Not available for sale in the United States*

27.2 SpO₂

27.2.1 Masimo SpO₂ Module

PART NUMBER	DESCRIPTION
0020-00-0154	LNCS® Adult/Pediatric starter kit
0020-00-0156	LNCS® Adult/Pediatric disposable starter kit
0020-00-0155	LNCS® Neonatal disposable starter kit
0600-00-0126	LNCS DC-I Adult finger reusable sensor
0600-00-0127	LNCS DC-IP Pediatric finger reusable sensor
0600-00-0121	LNCS ADTX Adult single patient adhesive sensors
0600-00-0122	LNCS PDTX Pediatric single patient adhesive sensors
0600-00-0123	LNCS INF-L Infant single patient adhesive sensors**
0600-00-0124	LNCS NEO-L Neonatal single patient adhesive sensors**
0600-00-0125	LNCS NEO PT-L Neonatal preterm patient adhesive sensors **
0012-00-1652	LNC-4 SpO ₂ Patient cable
0012-00-1599	LNC-10 SpO ₂ Patient cable
0012-00-1653	LNC-14 SpO ₂ Patient cable
0012-00-1651	LNCS to LNOP PC series adapter
0012-00-1656	Masimo SET AC-1 LNCS adapter cable
0600-00-0047	LNOP® DCI-Adult reusable finger sensor
0600-00-0063	LNOP® DCIP-Pediatric/slender digit reusable finger sensor
0600-00-0110	LNOP® TC-I TipClip Ear Sensor
0600-00-0086	Ear Clip
0600-00-0087	Ear Hanger
0600-00-0078	LNOP® YI-Multisite reusable sensor
0600-00-0081	Multisite wrap
0600-00-0083	Multisite wrap, foam
0600-00-0077	LNOP® DCSC-Adult spot check reusable sensor
0012-00-1099-01	PC08-SpO ₂ cable
0012-00-1099-02	PC12-SpO ₂ cable
0600-00-0043-01	LNOP® Adt-Adult single patient adhesive sensors
0600-00-0044-01	LNOP® Pdt-Pediatric/slender digit single patient sensors
0600-00-0100	LNOP® II Inf-L-Infant L single patient adhesive sensors
0600-00-0108	Replacement tapes for LNOP® II Inf-L-Infant L single patient adhesive sensors**
0600-00-0045-01	LNOP® Neo-Neonatal Y single patient adhesive sensors-for patients more than 1 kg. and less than 10 kgs.**
0600-00-0065	Adhesive tapes for Neonatal Y single patient adhesive sensors
0600-00-0099	LNOP® II Neo-Neonatal L single patient adhesive sensors-for patients more than 1 kg. and less than 10 kgs.
0600-00-0096	Adhesive tapes for Neonatal L single patient adhesive sensors
0600-00-0046-01	LNOP® NeoPt-Preterm neonatal Y single patient adhesive sensors-for patients less than 1 kg.

** Discontinued by manufacturer

PART NUMBER	DESCRIPTION
0600-00-0064	Posey wraps for Preterm neonatal Y single patient adhesive sensors**
0600-00-0098	LNOP® II NeoPt-L-Preterm neonatal L single patient adhesive sensors-for patients less than 1 kg.
0600-00-0097	Posey wraps for Preterm neonatal L single patient adhesive sensors**
0600-00-0084	Clothing clips
0600-00-0085	Adhesive squares**

** Discontinued by manufacturer

27.2.2 Nellcor® SpO₂ Module

PART NUMBER	DESCRIPTION
9000-10-05161	Reusable Sensor
0012-00-1464	SpO ₂ cable, DOC-10, OxiMax
0600-00-0103	Disposable Nellcor OxiMax Sensor Kit***
9000-10-07308	OXI-P/I reusable sensor, Ped/Inf*
0010-10-12476	Dura-Y Multi-Site sensor, Adu/Ped/Neo/Inf*
0010-10-12202	MAXAI disposable sensor, Adu, >30kg, 24 pcs/box*
0010-10-12203	MAXPI disposable sensor, Ped, 10 to 50kg, 24 pcs/box*
0010-10-12204	MAXII disposable sensor, Inf, 3 to 20kg, 24 pcs/box*
0010-10-12205	MAXNI disposable sensor, Adu/Neo, >40kg or <3kg, 24 pcs/box*

* Not available for sale in the United States

*** One Nellcor sensor ships with each Nellcor SpO₂ VPS module. Order subsequent Nellcor sensors from Nellcor (requesting P/N 9000-10-05161) by calling 1-800-NELLCOR or go to www.Nellcor.com.

27.3 NIBP

PART NUMBER	DESCRIPTION
0020-00-0184-01	Reusable NIBP cuffs starter kit
0683-15-0001-01	Reusable NIBP cuff, Child, 10 to 19 cm, quick connect
0683-15-0002-01	Reusable NIBP cuff, Small Adult, 18 to 26 cm, quick connect
0683-15-0003-01	Reusable NIBP cuff, Adult, 25 to 35 cm, quick connect
0683-15-0004-01	Reusable NIBP cuff, Large Adult, 33 to 47 cm, quick connect
0683-15-0005-01	Reusable NIBP cuff, Thigh, 46 to 66 cm, quick connect
0683-15-0007-01	Reusable NIBP Cuff, Adult Long, 27.5 – 36.5 cm, quick connect
0683-15-0006-01	Reusable NIBP Cuff, Large Adult Long, 35.5-46 cm, quick connect
0683-14-0001-01	Disposable NIBP cuff, Child, 10 to 19 cm, quick connect, box of 10
0683-14-0002-01	Disposable NIBP cuff, Small Adult, 18 to 26 cm, quick connect, box of 10
0683-14-0003-01	Disposable NIBP cuff, Adult, 25 to 35 cm, quick connect, box of 10
0683-14-0004-01	Disposable NIBP cuff, Large Adult, 33 to 47 cm, quick connect, box of 10
0683-14-0005-01	Disposable NIBP cuff, Thigh, 46 to 66 cm, quick connect, box of 10

PART NUMBER	DESCRIPTION
0683-14-0007-01	Disposable NIBP Cuff, Adult Long, 27.5 – 36.5 cm, quick connect
0683-14-0006-01	Disposable NIBP Cuff, Large Adult Long, 35.5 - 46 cm, quick connect, box of 10
0683-23-0001	Neonatal Size 1: limb circumference 3 – 6 cm, box of 10
0683-23-0002	Neonatal Size 2: limb circumference 5 – 8 cm, box of 10
0683-23-0003	Neonatal Size 3: limb circumference: 7 – 10 cm, box of 10
0683-23-0004	Neonatal Size 4: limb circumference 9 – 13 cm, box of 10
0683-23-0005	Neonatal Size 5: limb circumference 12 – 17 cm, box of 10
0683-04-0003	NIBP Hose, 5' (1.5 m), Quick Connect to Quick Connect
0683-04-0004	NIBP Hose, 10' (3.5 m), Quick Connect to Quick Connect

27.4 Temperature

27.4.1 Disposable 400 Series Temperature Probes

PART NUMBER	DESCRIPTION
0206-03-0112-02	Esophageal Stethoscope, 400 Series Disposable Temperature Probe, 12 Fr, ES 400-12
0206-03-0118-02	Esophageal Stethoscope, 400 Series Disposable Temperature Probe, 18 Fr, ES 400-18
0206-03-0209-02	Esophageal/Rectal, 400 Series Disposable Temperature Probe, 9 Fr, ER 400-9
0206-03-0212-02	Esophageal/Rectal, 400 Series Disposable Temperature Probe, 12 Fr, ER 400-12
0206-03-0300-02	Skin, 400 Series Disposable Temperature Probe, SK 400
040-000091-00	Reusable Instrument Cable, 400 Series
040-000055-00	5 pin Temp probe, Adult Esophageal/Rectal
040-000057-00	5 pin Temp probe, Adult skin
040-000056-00	5 pin Temp probe, Pediatrics Esophageal/Rectal
040-000058-00	5 pin Temp probe, Pediatrics skin
040-000100-00	5pin Temp adapter cable (Not for Clinical Use)

27.5 IBP

PART NUMBER	DESCRIPTION
040-000053-00	IBP Cable, BD P10EZ-1, P23XL-1, DTX/Plus
040-000054-00	IBP cable for Edwards Life Sciences TruWave PX
040-000052-00	IBP cable for Hospira Transpac IV
040-000096-00	IBP cable adapter
6000-10-02107	BD, Disposable pressure Transducer*
0010-10-42638	Abbott, Disposable Transducer*
0010-10-12156	BD, Transducer/manifold mount*
M90-000133---	Abbott, Steady rest for IBP Transducer and Clamp*
M90-000134---	Abbott, Mounting clamp for IBP transducer (Hospira, send with the cable)*

* Not available for sale in the United States

27.6 CO₂

27.6.1 Oridion Microstream CO₂ Module

PART NUMBER	DESCRIPTION
0008-00-0332-01	CO ₂ Exhaust connector assembly
0075-00-0033-01	Calibration gas
0020-00-0188-01	Adult FilterLine Kit
0010-10-42560	Oridion FilterLine Set, Adult/Pediatric*
0010-10-42563	Oridion FilterLine Set Adult/Pediatric Long*
0010-10-42561	Oridion FilterLine Humidified Set Adult/Pediatric*
0010-10-42562	Oridion FilterLine Humidified Set Infant/Neonatal*
0010-10-42564	Oridion FilterLine Humidified Set Adult/Pediatric Long*
0010-10-42565	Oridion FilterLine Humidified Set Infant/Neonatal Long*
0010-10-42566	Oridion Smart CapnoLine Plus Adult/Intermediate*
0010-10-42567	Oridion Smart CapnoLine Pediatric*
0010-10-42577	Oridion NIV-Line Adult*
0010-10-42578	Oridion NIV-Line Pediatric*
0010-10-42572	Oridion CapnoLine Humidified Adult*
0010-10-42573	Oridion CapnoLine Humidified Pediatric*
0010-10-42574	Oridion CapnoLine Humidified Infant/Neonatal*

* Not available for sale in the United States

PART NUMBER	DESCRIPTION
0010-10-42575	Oridion CapnoLine Humidified O ₂ Adult*
0010-10-42576	Oridion CapnoLine Humidified O ₂ Pediatric*
0010-10-42568	Oridion Smart CapnoLine Plus O ₂ Adult/Intermediate*
0010-10-42569	Oridion Smart CapnoLine O ₂ Pediatric*
0010-10-42570	Oridion Smart CapnoLine Plus O ₂ Adult/Intermediate Long*
0010-10-42571	Oridion Smart CapnoLine O ₂ Pediatric Long*
040-000027-00	Oridion CO ₂ Kit Infant/Neonatal*
040-000027-00	Oridion CO ₂ Kit Adult/Pediatric*

* *Not available for sale in the United States*

27.7 CO

PART NUMBER	DESCRIPTION
0012-00-1447-01	Cardiac output cable
0012-00-1519	Cardiac output probes
0012-00-1520	Cardiac output probes (Edward)
6000-10-02079	BD, IT sensor (OHMEDA P /N: SP4042 'BD')*
6000-10-02080	BD, IT sensor housing (OHMEDA P /N: SP5045 'BD')*
6000-10-02081	Medex, 12CC contrl syringe W /1CC Stop W /Rotator*
0010-10-12317	Edward, CO syringe (93610 "EDWARTDS")*
6000-10-02183	Edward, Dilution hose (131HF7 'Edwards' or 'Baxter')*

* *Not available for sale in the United States*

27.8 Miscellaneous Accessories

PART NUMBER	DESCRIPTION
0146-00-0091-01	Li-Ion Battery
0012-00-1801-01	Terminated pigtail cable for analog out interface to Maquet balloon pump
0012-00-1801-02	Unterminated pigtail cable for analog out
022-000113-00	Analog Output Connector Adapter
0012-00-1277-02	Nurse call cable
0012-25-0001	Power Cord 110 Volt (US market)
0012-25-0002	Power Cord 220 Volt (European Market)
0012-25-0003	Power Cord 240 Volt (UK Market)
0000-10-10903	Power Cord (Indian Market)
509B-10-05996	Power Cord (Chinese Market)
0160-00-0126-01	Color flat panel secondary display
023-000288-00	V Series USB Memory Stick, 8GB
023-000287-00	V Series USB Memory Stick, 16GB (for Service use only)
0012-00-1803-15	Cable, mod bus, powered USB, 2F, 4'
0012-00-1803-12	Cable, mod bus, powered USB, 2F, 6'
0012-00-1803-13	Cable, mod bus, powered USB, 2F, 12'
0012-00-1275-01	Serial Port Cable 10'
009-002156-00	Serial Port Adapting Cable (A Type/72")
009-002157-00	Serial Port Adapting Cable (A Type/114")
009-002237-00	Serial Port Adapting Cable (C Type)
0012-00-1276-02	PASS2 SPECTRUM TO GM 72"
115-016069-00	Kit, Camino Adapters
023-000248-00	V Series USB Mouse
023-000247-00	V Series USB Keyboard
0000-10-10792	Mouse*
0000-10-11060	Keyboard*
0683-00-0422-02	Chart/thermal paper (box of 10 rolls)
0683-00-0422-01	Chart/thermal paper (single roll)

* *Not available for sale in the United States*

27.9 Mounts & Mounting Accessories

PART NUMBER	DESCRIPTION
115-005392-00	Rolling Stand Assembly
115-003088-00	Mounting Bracket for Rolling Stand
115-006911-00	V Series VHM Wall Mount Assembly
045-000295-00	Telescoping Down Post
045-000305-00	Non-telescoping Down Post
115-006912-00	V Series Modules Rack Wall Mount Assembly
115-005389-00	V Hub Mounting Cleat
115-005387-00	Docking station Mounting Plate
034-000108-00	VHM Cable Management Clips
034-000109-00	Wall Channel Cover
045-000297-00	V Hub quick release mounting plate

27.10 Networking Accessories

PART NUMBER	DESCRIPTION
0992-00-0091-07	Laser Printer - HP4015N
0992-00-0091-08	Laser Printer -LaserJet Enterprise M602
0012-00-1274-01	CAT 5 Ethernet Cable, Patch, STP, 6' (1.83m)
0012-00-1274-02	CAT 5 Ethernet Cable, Patch, STP, 25' (7.62m)
0012-00-1274-03	CAT 5 Ethernet Cable, Patch, STP, 50' (15.24m)
0012-00-1392-05	CAT 5 Ethernet Cable, Crossover, STP, 3' (0.91 m)
0012-00-1392-06	CAT 5 Ethernet Cable, Crossover, STP, 6' (1.83 m)
0012-00-1392-07	CAT 5 Ethernet Cable, Crossover, STP, 10' (3.05 m)
0012-00-1392-08	CAT 5 Ethernet Cable, Crossover, STP, 20' (6.10 m)

** The Networking Installation charge includes appropriate interface cables, jacks, wall plates, certification and labor for a certified contractor. Does not include laser printer, hub or comm-ports.*

27.11 Manuals

PART NUMBER	DESCRIPTION
0070-CD-0727-02	V 12/V 21 Operators Manual - International English CD
0070-00-0727-02	V 12/V 21 Operators Manual - International English
046-004985-00	12-Lead ECG Interpretive Program Physician Manual
046-001131-00	V 12/V 21 Service Manual

Product Specifications

Specifications	28-2
Impedance Respiration	28-25
Non-Invasive Blood Pressure (NIBP)	28-28
Invasive Blood Pressure (IBP).....	28-32
Temperature.....	28-34
Pulse Oximetry (SpO2).....	28-36
Analog Output.....	28-39
Thermodulation Cardiac Output (CO).....	28-40
Carbon Dioxide (CO2)	28-41
Drug Calculations	28-44
Patient Contacting Materials	28-44
Power Specifications.....	28-45
Performance Characteristics	28-46
Safety Designations.....	28-49
Electromagnetic Capability	28-50
Environmental Conditions	28-54
Sound.....	28-54
Communication Protocols.....	28-54
Connection to Panorama [®] Central Station.....	28-54
Operator Position.....	28-54

28.1 Specifications

28.1.1 Standards Compliance

The **V 12/V 21** Monitor is in compliance with following industry standards.

TABLE 28-1

EN60601-1:1990+A1:1993+A2:1995+A3:1996/ IEC 60601-1:1988 +A1:1991 +A2:1995	Medical electrical Equipment - General Requirements for Safety
UL 60601-1:2003	Medical electrical Equipment - General Requirements for Safety
CAN/CSA-C22.2 NO. 601.1M90: 2005	Medical Electrical Equipment - General Requirements for Safety
EN 60601-1-1:2001/ IEC 60601-1-1:2000	Medical electrical equipment - Part 1-1: General requirements for safety - Collateral standard: Safety requirements for medical electrical systems
IEC 60601-1-2:2007/EN 60601-1-2:2007	Medical electrical equipment - Part 1-2: General requirements for safety - Collateral standard: Electromagnetic compatibility - Requirements and tests
IEC 60601-1-4:2000	Medical electrical equipment - Part 1-4: General requirements for safety - Collateral standard: Programmable electrical medical systems
IEC62366: 2007	Application of Usability Engineering to medical devices
IEC 60601-1-6:2006	Medical electrical equipment - Part 1-6: General requirements for safety - Collateral standard: Usability
EN 60601-2-34:2001 / IEC 60601-2-34:2000	Medical electrical equipment - Part 2-34: Particular requirements for the safety, including essential performance, of invasive blood pressure monitoring equipment
IEC 60601-1-8:2006/ EN 60601-1-8:2007	Collateral Standard: General requirements, tests and guidance for alarm systems in medical electrical equipment and medical electrical systems
EN 60601-2-49:2001 / IEC 60601-2-49:2001	Particular requirements for the safety of multifunction patient monitoring equipment
IEC 60601-2-27:2005	Medical electrical equipment, Part 2: Particular requirements for the safety of electrocardiographic monitoring equipment
IEC 60601-2-25:1993/A1:1999	Medical electrical equipment, Part 2: Particular requirements for the safety of electrocardiographs
EN 60601-2-30:2000 / IEC 60601-2-30:1999	Medical electrical equipment, Part 2: Particular requirements for the safety, including essential performance, of automatic cycling non-invasive blood pressure monitoring equipment.
EN 1060-1:1995 + A1:2002+ A2:2009	Non-invasive sphygmomanometers - Part 1: General requirements
ISO 10993-1:2003/EN ISO 10993-1:2009	Biological evaluation of medical devices - Part 1: Evaluation and testing
EN 980: 2008	Graphical Symbols for Use in the Labeling of Medical Devices
EN 1041:1998	Information supplied by the manufacturer of medical devices
AAMI/ANSI HE74:2001	Human Factors Design Process for Medical Devices

TABLE 28-1

ISO 15223-1: 2012	Medical devices - Symbols to be used with medical device labels, labeling and information to be supplied
ISO 9919:2005/EN ISO 9919:2009	Medical electrical equipment - Particular requirements for the basic safety and essential performance of pulse oximeter equipment for medical use
EN 1060-3:1997 + A1:2005+ A2:2009	Non-invasive sphygmomanometers - Part 3: Supplementary requirements for electro-mechanical blood pressure measuring systems
ANSI/AAMI SP10:2002 + A1:2003 + A2:2006	Manual, electronic or automated sphygmomanometers
EN 12470-4:2000+A1:2009	Performance of electrical thermometers for continuous measurement
ASTM E1112-00 (2006)	Standard Specification for Electronic Thermometers for Intermittent Determination of Patient Temperature
EC13: 2002/(R) 2007	Cardiac monitors, heart rate meters, and alarms
EC11: 1991/(R) 2007	Diagnostic electrocardiographic devices
EC57:1998/(R)2003	Testing and Reporting Performance Results of Cardiac Rhythm and ST-Segment Measurement Algorithms
ISO21647:2004+Cor 2005/EN ISO 21647:2009	Medical electrical equipment - Particular requirements for the basic safety and essential performance of respiratory gas monitors
EC53:1995/(R)2001	ECG cables and lead wires

28.1.2 V 12 Safety Designations:

TABLE 28-2

Type of protection against electric shock:	Class II with internal electric power source. Where the integrity of the external protective earth (ground) in the installation or its conductors is in doubt, the equipment shall be operated from its internal electric power source (batteries).
Supply Connection:	14.3Amps (max), +15Vdc Input 11.1 VDC Removable Battery 3.7 VDC Internal Backup Battery
Mode of Operation:	Continuous
Protection Against Hazards of Explosion:	Not protected (Ordinary)
Protection Against Ingress of Liquids	Drip-proof (IPX1)
Degree of electrical connection between equipment and patient	Equipment designed for direct electrical and non-electrical connection to the patient
Degree of Mobility:	Portable
Maximum Size:	13.7"H x 9.4"W x 7.5"D
Maximum Weight:	8.9 lbs. (without batteries) 13.00 lbs (monitor with three (3) batteries, and VPS
Operating Temperature:	+5°C to +40°C

TABLE 28-2

Operating Humidity:	15% to 95%, non-condensing
Operating Altitude:	1060hPa to 700hPa
Storage Temperature:	-20°C to +60°C
Storage Humidity:	10% to 95%, non-condensing
Storage Altitude:	1060hPa to 570hPa
Controls/Indicators:	1- Touchscreen 1- 12.1" TFT Display 2- Alarm LED
Display	Operates in portrait orientation Minimum +50/-50 degree horizontal viewing angle Minimum +45/-45 degree vertical viewing angle Aspect ratio of 3:4 in portrait mode Display resolution is 1024 x 768 pixels
Interfaces:	1- Diagnostic Port (DP1) 1- V Dock Interface (D1) 1- V Hub Interface (MR4) 3- Battery Interface (1, 2, 3) 6 - Module bays (M1-M6)

28.1.3 V 21 Safety Designations:

TABLE 28-3

Type of protection against electric shock:	Class II
Supply Connection:	14.3Amps (max), +15Vdc Input 3.7 VDC Internal Backup Battery
Mode of Operation:	Continuous
Protection Against Hazards of Explosion:	Not protected (Ordinary)
Protection Against Ingress of Liquids	Drip-proof (IPX1)
Degree of electrical connection between equipment and patient	Equipment designed for direct electrical and non-electrical connection to the patient
Degree of Mobility:	Stationary
Maximum Size:	23"H x 16"W x 9"D
Maximum Weight:	23 lbs.
Operating Temperature:	+5°C to +40°C
Operating Humidity:	15% to 95%, non-condensing
Operating Altitude:	1060hPa to 700hPa
Storage Temperature:	-20°C to +60°C
Storage Humidity:	10% to 95%, non-condensing
Storage Altitude:	1060hPa to 570hPa

TABLE 28-3 (Continued)

Controls/Indicators:	1- Touchscreen 1- 21.3" TFT Display 2- Alarm LED 1 - Touchpad
Display:	Operates in portrait orientation Minimum +50/-50 degree horizontal viewing angle Minimum +45/-45 degree vertical viewing angle Aspect ratio of 3:4 in portrait mode Display resolution is 1600 x 1200 pixels
Interfaces:	1- Diagnostic Port (DP1) 1- V Dock Interface (D1) 1- V Hub Interface (MR4) 1- AC Present

28.1.4 V Dock Safety Designations:

TABLE 28-4

Type of protection against electric shock:	Class I
Supply Connection (Input):	90Vac min - 264 Vac max 47Hz min, 63 Hz max, Single Phase
Supply Connection (Output):	14.3Amps (max), +15Vdc Output
Mode of Operation:	Continuous
Protection Against Hazards of Explosion:	Not protected (Ordinary)
Protection Against Ingress of Liquids	Drip-proof (IPX1)
Degree of electrical connection between equipment and patient:	Equipment designed for non-electrical connection to the patient
Degree of Mobility:	Portable
Maximum Size:	6.2"H x 7.6"W x 9.9"D
Maximum Weight:	3.5 lbs.
Operating Temperature:	+5°C to +40°C
Operating Humidity:	15% to 95%, non-condensing
Operating Altitude:	1060hPa to 700hPa
Storage Temperature:	-20°C to +60°C
Storage Humidity:	10% to 95%, non-condensing
Storage Altitude:	1060hPa to 570hPa
Controls/Indicators:	1- AC Present 1- Battery(ies) Charging

TABLE 28-4 (Continued)

Interfaces:	1 - V Dock Interface (D1) 3 - V Hub Interface (MR1- MR3) 3 - Serial Bus (SB1-SB3) 1 - Nurse Call (NC1) 1 - Video (DV1) 1 - Ethernet (CS1) 1 - AC Inlet
-------------	--

28.1.5 VPS Safety Designations:

TABLE 28-5

Type of protection against electric shock:	Class II
Degree of protection against electric shock:	ECG - Type CF defibrillation protected IBP - Type CF defibrillation protected Temperature - Type CF defibrillation protected NIBP - Type BF defibrillation protected SpO ₂ -Type BF
Supply Connection:	+12VDC, +5VDC from M1 through M6
Mode of Operation:	Continuous
Protection Against Hazards of Explosion:	Not protected (Ordinary)
Protection Against Ingress of Liquid's	Drip-proof (IPX1)
Degree of electrical connection between equipment and patient	Equipment designed for direct electrical and non-electrical connection to the patient
Degree of Mobility:	Portable
Maximum Size:	2.988"H x 6.2"W x 5.5"D
Maximum Weight:	1.95 lbs.
Operating Temperature:	+5°C to +40°C
Operating Humidity:	15% to 95%, non-condensing
Operating Altitude:	1060hPa to 700hPa
Storage Temperature:	-20°C to +60°C.
Storage Humidity:	10% to 95%, non-condensing.
Storage Altitude:	1060hPa to 570hPa
Controls/Indicators:	1- Button, Silence All Alarms 1- Zero All IBPs Button, Start/Stop NIBP 1- LED, Powered and Communicating
Interfaces:	1- Non-Invasive Blood Pressure 1 - Temperature 2- Invasive Blood Pressure 1- ECG 1- Nellcor SpO ₂ or Masimo SpO ₂ 2 - Analog Output 2 - Mx & My Module Bay Connectors

28.1.6 V Hub Safety Designations:

TABLE 28-6

Type of protection against electric shock:	Class II
Supply Connection:	+12 VDC, +5 VDC from monitor
Mode of Operation:	Continuous
Protection Against Hazards of Explosion:	Not protected (Ordinary)
Protection Against Ingress of Liquids	Drip-proof (IPX1)
Degree of electrical connection between equipment and patient	Equipment designed for direct electrical and non-electrical connection to the patient
Degree of Mobility:	Portable
Maximum Size:	10"H x 8"W x 5"D
Maximum Weight:	3.0 lbs
Operating Temperature:	+5°C to +40°C
Operating Humidity:	15% to 95%, non-condensing
Operating Altitude:	1060hPa to 700hPa
Storage Temperature:	-20°C to +60°C
Storage Humidity:	10% to 95%, non-condensing
Storage Altitude:	1060hPa to 570hPa
Controls/Indicators:	1 - Lock control 1 - Indicator light
Interfaces:	1 - V 12/V 21 Connector

28.1.7 12 Lead ECG Safety Designations:

TABLE 28-7

Type of protection against electric shock:	Class II
Degree of protection against electric shock:	ECG- Type CF defibrillation protected
Supply Connection:	+3.3 VDC from VPS
Mode of Operation:	Continuous
Protection Against Hazards of Explosion:	Not protected (Ordinary)
Protection Against Splashing Water:	IPX4
Degree of electrical connection between equipment and patient	Equipment designed for direct electrical connection to the patient
Degree of Mobility:	Portable
Maximum Size:	1.1"H x 2.6"W x 4.6"D
Maximum Weight:	1.02 lbs.

TABLE 28-7 (Continued)

Operating Temperature:	+5°C to +40°C
Operating Humidity:	15% to 95%, non-condensing
Operating Altitude:	1060hPa to 700hPa
Storage Temperature:	-20°C to +60°C
Storage Humidity:	10% to 95%, non-condensing.
Storage Altitude:	1060hPa to 570hPa
Controls/Indicators:	1- LED, Powered and Communicating
Interfaces:	1- 12 Lead Yoke Cable 1- VPS ECG Interface Cable

28.1.8 CO Module Safety Designations:

TABLE 28-8

Type of protection against electric shock:	Class II
Degree of protection against electric shock:	Cardiac Output - Type CF defibrillation protected
Supply Connection:	+12VDC, +5VDC from Module Bay
Mode of Operation:	Continuous
Protection Against Hazards of Explosion:	Not protected (Ordinary)
Protection Against Ingress of Liquid's	Drip-proof (IPX1)
Degree of electrical connection between equipment and patient:	Equipment designed for direct electrical connection to the patient
Degree of Mobility:	Portable
Maximum Size:	0.988"H x 6.2"W x 5.5"D
Maximum Weight:	0.74 lbs.
Operating Temperature:	+5°C to +40°C
Operating Humidity:	15% to 95%, non-condensing
Operating Altitude:	1060hPa to 700hPa
Storage Temperature:	-20°C to +60°C
Storage Humidity:	10% to 95%, non-condensing
Storage Altitude:	1060hPa to 570hPa
Controls/Indicators:	1- Button, Start CO Run 1- LED, Powered and Communicating
Interfaces:	1- CO 1 - Module Bay (Mx)

28.1.9 CO₂ Module Safety Designations:

TABLE 28-9

Type of protection against electric shock:	Class II
Degree of protection against electric shock:	CO ₂ - Type BF, Non-Defib Proof
Supply Connection:	+12VDC, +5VDC
Mode of Operation:	Continuous
Protection Against Hazards of Explosion:	Not protected (Ordinary)
Protection Against Ingress of Liquids:	Drip-proof (IPX1)
Degree of electrical connection between equipment and patient:	Equipment designed for direct electrical connection to the patient
Degree of Mobility:	Portable
Maximum Size:	1.988"H x 6.2"W x 5.5"D
Maximum Weight:	1.12 lbs.
Operating Temperature:	+5°C to +40°C
Operating Humidity:	15% to 95%, non-condensing
Operating Altitude:	1060hPa to 700hPa
Storage Temperature:	-20°C to +60°C
Storage Humidity:	10% to 95%, non-condensing
Storage Altitude:	1060hPa to 570hPa
Controls/Indicators:	1- LED, Powered and Communicating
Interfaces:	1- CO ₂ Exhaust 1- CO ₂ 1- Module Bay (Mx)

28.1.10 IBP Module Safety Designations:

TABLE 28-10

Type of protection against electric shock:	Class II
Degree of protection against electric shock:	IBP- Type CF defibrillation protected
Mode of Operation:	Continuous
Supply Connection:	+12VDC, +5VDC from Module Bay
Protection Against Hazards of Explosion:	Not protected (Ordinary)
Protection Against Ingress of Liquid's	Drip-proof (IPX1)
Degree of electrical connection between equipment and patient	Equipment designed for direct electrical and non-electrical connection to the patient
Degree of Mobility:	Portable
Maximum Size:	0.988"H x 6.2"W x 5.5"D

TABLE 28-10 (Continued)

Maximum Weight:	0.75 lbs.
Operating Temperature:	+5°C to +40°C
Operating Humidity:	15% to 95%, non-condensing
Operating Altitude:	1060hPa to 700hPa
Storage Temperature:	-20°C to +60°C
Storage Humidity:	10% to 95%, non-condensing
Storage Altitude:	1060hPa to 570hPa
Controls/Indicators:	1- Button, Zero IBP 1- LED, Powered and Communicating
Interfaces:	2- IBP 1- Module Bay (Mx)

28.1.11 Temp Module Safety Designations:

TABLE 28-11

Type of protection against electric shock:	Class II
Degree of protection against electric shock:	Type CF defibrillation protected
Mode of Operation:	Continuous
Supply Connection:	+12VDC, +5VDC from Module Bay
Protection Against Hazards of Explosion:	Not protected (Ordinary)
Protection Against Ingress of Liquids:	Drip-proof (IPX1)
Degree of electrical connection between equipment and patient:	Equipment designed for direct electrical and non-electrical connection to the patient
Degree of Mobility:	Portable
Maximum Size:	0.988"H x 6.2"W x 5.5"D
Maximum Weight:	0.75 lbs.
Operating Temperature:	+5°C to +40°C
Operating Humidity:	15% to 95%, non-condensing
Operating Altitude:	1060hPa to 700hPa
Storage Temperature:	-20°C to +60°C
Storage Humidity:	10% to 95%, non-condensing
Storage Altitude:	1060hPa to 570hPa
Controls/Indicators:	1- LED, Powered and Communicating 2- LED, Channel Indicators
Interfaces:	1- Temp 1- Module Bay (Mx)

28.1.12 Recorder Safety Designations:

TABLE 28-12

Type of protection against electric shock:	Class II
Degree of protection against electric shock:	Recorder Module- Not protected
Mode of Operation:	Continuous
Supply Connection:	+12VDC, +5VDC from Module Bay and V Hub
Protection Against Hazards of Explosion:	Not protected (Ordinary)
Protection Against Ingress of Liquids:	Drip-proof (IPX1)
Degree of electrical connection between equipment and patient:	None
Degree of Mobility:	Portable
Maximum Size:	2.996"H x 6.2"W x 5.5"D
Maximum Weight:	1.50 lbs.
Operating Temperature:	+5°C to +40°C
Operating Humidity:	10% to 95%, non-condensing
Operating Altitude:	1060hPa to 700hPa
Storage Temperature:	-20°C to +60°C
Storage Humidity:	10% to 95%, non-condensing
Storage Altitude:	1060hPa to 570hPa
Controls/Indicators:	1- LED, Powered and Communicating 1- Button, Recorder Door Release 1- Button, Print
Interfaces:	2- Mx & My Module Bay Connectors

28.1.13 VDI Safety Designations:

TABLE 28-13

Type of protection against electric shock:	Class II
Degree of protection against electric shock:	Not protected (Ordinary)
Mode of Operation:	Continuous
Supply Connection:	+12VDC, +5VDC from Module Bay
Protection Against Hazards of Explosion:	Not protected (Ordinary)
Protection Against Ingress of Liquids:	Drip-proof (IPX1)
Degree of electrical connection between equipment and patient:	None
Degree of Mobility:	Portable
Maximum Size:	.996"H x 6.2"W x 5.5"D

TABLE 28-13 (Continued)

Maximum Weight:	.68 lbs.
Operating Temperature:	+5°C to +40°C
Operating Humidity:	15% to 95%, non-condensing
Operating Altitude:	1060hPa to 700hPa
Storage Temperature:	-20°C to +60°C
Storage Humidity:	10% to 95%, non-condensing
Storage Altitude:	1060hPa to 570hPa
Controls/Indicators:	1- LED, Powered and Communicating
Interfaces:	2- Mx & My Module Bay Connectors 1- V Hub connector 1 - DB-0 Male Interface Connector

28.1.14 Visual and Auditory Alarm Disclosure

- The **V 12/V 21** I/O Processor generates a high priority LED alarm.
- The high priority LED alarm has a flashing frequency of 2 Hz.
- The high priority LED alarm has a duty cycle of 50%.
- The **V 12/V 21** I/O Processor generates a medium priority LED alarm.
- The medium priority LED alarm has a flashing frequency of 0.5 Hz.
- The medium priority LED alarm has a duty cycle of 50%.
- The **V 12/V 21** I/O Processor generates a low priority LED alarm.
- The low priority LED alarm is constantly on.
- The low priority LED alarm has a duty cycle of 100%.

28.1.15 Verifying Alarm Functionality

28.1.15.1 Self-Test of Alarm System

Requirements for alarm sound: adopt low-priority alarm sound of the alarm system. The alarm sound volume is 5.

Alarms can be verified by creating an alarm condition on the **V 12/V 21** and verifying the corresponding alarm indicators are present on the monitor.

Alarm Delay

- Apnea Alarm Delay settings are:-Adult: 10 to 60 seconds;
Pediatric/Neonate: 10 to 20 seconds
- ST Alarm Delay settings are:
Adult/Pediatric: 30 seconds/45 seconds/ 1 min/90 seconds/2 min/3 min.
- Alarm delay settings are:
None/1s/2s/3s/4s/5s/6s/7s/8s.

Audio alarm can be delayed for a predetermined time period, with the exception of Apnea, ST alarm, lethal Arrhythmia alarms, SpO₂ Desat and Insp O₂ shortage.

- When alarm is triggered, the alarm tone will not be presented, but the visual signal will be presented during delay time.

28.1.16 ECG Performance

V 12/V 21 in conjunction with:

A. VPS

1. Lead Definition

TABLE 28-14

ECG TYPE	ACQUIRED LEADS	DISPLAYABLE LEADS
3-Lead ECG	I, II, III	I, II, III (one vector at a time)
5-Lead ECG	I, II, and V (n)	I, II, III, aVR, aVL, aVF, V (n)
6-Lead ECG	I, II, V(n1), and V(n2)	I, II, III, aVR, aVL, aVF, Vx, Vy

2. 3/5/6 Lead ECG Cable Detection

The ECG System has a manual selection for 3, 5, or 6 leads cables when Mindray cables are used.

3. Defibrillator Overload protection

The ECG function is in accordance with the applicable requirements of EN 60601-2-27 and EN 60601-2-25.

4. Recovery

ECG System recovers automatically from defibrillator overload as per ANSI/AAMI EC11: 1991/(R) 2007 within 8 seconds. Monitor recovers automatically from defibrillator overload as per ANSI/AAMI EC13:2002/(R)2007 within 5 seconds.

5. AC Overload Protection

AC overload protection withstands 60Hz, 1V p-p for 10 seconds in accordance with applicable requirements of ANSI/AAMI EC13:2002/(R)2007 and ANSI/AAMI EC11: 1991/(R) 2007.

6. ESU Protection

None.

7. Electro Surgical Unit Noise Suppression

The peak noise during ESU operation for 3, 5, and 6-Lead ECG System is less than $\pm 2\text{mV}$ from ECG baseline when used with Mindray ESU cables.

8. ESU Withstand

3, 5, and 6-Lead ECG Systems withstand stress from a High Frequency Surgical Unit operating at 300 Watts in cut mode and 100 Watts in coagulate mode.

9. Input Impedance

Single ended input impedance of ECG System is greater than $2.5\text{M}\ \Omega$ as per ANSI/AAMI EC13:2002/(R)2007, 4.2.9.2 and ANSI/AAMI EC11: 1991/(R) 2007, 3.2.9.

10. Lead Fault

Lead resistances $\leq 51\text{K}\ \Omega$ in parallel with $0.047\mu\text{F}$ capacitance unable to cause a lead fault condition. Differential offsets $\leq \pm 300\text{mV}$ unable to cause a lead fault condition.

11. System Noise

System noise is less than 30 μV p-p, referred to input, through shielded 51K resistors in parallel with 47nF capacitors (ANSI/AAMI EC13:2002/(R)2007, 4.2.9.3 or ANSI/AAMI EC11: 1991/(R) 2007, 3.2.12).

12. Overall System Error

Overall system error is 5% or 40 μV , whichever is greater (ANSI/AAMI EC13:2002/(R)2007, 4.2.9.8 or ANSI/AAMI EC11: 1991/(R) 2007, 3.2.7).

13. Gain Stability

The gain change one minute after energizing does not exceed 0.66 percent per minute. The total change in one hour does not exceed ± 10 percent of any available fixed gain setting. (ANSI/AAMI EC13:2002/(R)2007, 4.2.9.5 (d) or ANSI/AAMI EC11: 1991/(R) 2007, 3.2.4.4).

14. Multichannel Crosstalk

Multichannel crosstalk is a maximum of 2%, per (ANSI/AAMI EC13:2002/(R)2007, 4.2.9.4 or ANSI/AAMI EC11: 1991/(R) 2007, 3.2.12.2).

15. Baseline Stability

Baseline stability is as per (ANSI/AAMI EC13:2002/(R)2007, 4.2.9.11 (b) or ANSI/AAMI EC11: 1991/(R) 2007, 3.2.13.2).

16. Frequency Response

TABLE 28-15

ECG Type	Bandwidth (-3db)		
	Monitor	Diagnostic	ST
3/5/6 Lead ECG	0.5 to 40 Hz	0.05 to 150 Hz	0.05 to 40 Hz

17. Impulse response

Impulse response is as per (ANSI/AAMI EC13:2002/(R)2007, 4.2.9.8 (c) or ANSI/AAMI EC11: 1991/(R) 2007, 3.2.7.2 (a), (b), Method A, D).

18. Notch Filter Selection

ECG System is equipped with 50 Hz or 60 Hz notch filter with option to turn off.

19. CMRR

CMRR is as per (ANSI/AAMI EC13:2002/(R)2007, 4.2.9.10 or ANSI/AAMI EC11: 1991/(R) 2007, 3.2.11).
Notch filter is turned off.

20. Pacer Enhancement

Pacer signals within the range $\pm 2\text{mV}$ and $\pm 700\text{mV}$ (RTI) amplitude with a maximum rise time of 100 μsec and with duration in the 0.1ms to 2.0ms range are enhanced on the display when the Pacer Enhancement Mode is turned ON.

21. Pacer Rejection

Pacer signals from $\pm 2\text{mV}$ to $\pm 700\text{mV}$ (RTI) amplitude and 0.1 ms to 2ms in duration, and a maximum of 100 μs rise time are rejected from the display when the Pacer Rejection Mode is ON.

22. ESIS Filtering

An ESU Interference filter provides greater than 90 dB attenuation at 500 kHz. The ESU Filter shall have the option of being turned off.

23. ESU Noise Detection

An ESU noise declaration is asserted if signals detected as pacers are detected at rate greater than 50 Hz. No noise declaration will be asserted if pacer like signals are detected at rate greater than 10 MHz.

24. ECG Heart Rate Meter

The ECG heart rate meter function is derived from the ECG waveform.

Range:

TABLE 28-16

ECG Source:	Neonatal Range (BPM)	Pediatric Range: (BPM)	Adult Range: (BPM)
3/5/6 Lead ECG	30 to 350	30 to 300	30 to 300

25. Resolution

Resolution is 1 BPM.

26. Accuracy

Accuracy is ± 3 BPM or $\pm 3\%$ from 30 to 250 BPM, whichever is greater and $\pm 5\%$ in the 251 to 350 BPM range.

27. Out of Range

For values outside the specified measurement range, the heart rate meter indicates invalid data as (-).

28. Trigger Indication

There is an audible beep on every beat captured, if enabled.

29. Trigger Threshold

Heart rate meter does not trigger on signals having a QRS amplitude of less than 0.2 mV, or a duration of 10 msec or less with an amplitude of 1 mv (ANSI/AAMI EC13:2002/(R)2007, 4.2.6.1) in ADULT mode only.

30. Detectable QRS Width

70 to 120 msec, minimum for Adults and 40 to 120 msec, minimum, for Pediatric and Neonate patients as per ANSI/AAMI EC13:2002/(R)2007, 4.2.6.1

31. 60 Hz Voltage Tolerance

Heart rate meter is able to tolerate 60 Hz sinusoidal voltage less than or equal to 100 μ V p-p RTI as per ANSI/AAMI EC13:2002/(R)2007, 4.2.6.2.

32. Drift Tolerance

Heart rate meter is able to tolerate triangular wave of 0.1 Hz, 4mV p-p RTI superimposed on ECG per ANSI/AAMI EC13:2002/(R)2007, 4.2.6.3.

33. Time to Alarm for Cardiac Standstill

The time to alarm for a step change in heart rate from 80 BPM to 0 BPM, with lower alarm limit set to closest to 60 BPM does not exceed 10 seconds as per ANSI/AAMI EC13:2002/(R)2007 Section 4.2.8.4.

34. Time to Alarm for Low Heart Rate

The time to alarm for a step change in heart rate from 80 BPM to 40 BPM, with lower alarm limit set to closest to 60 BPM, does not exceed 10 seconds as per ANSI/AAMI EC13:2002/(R)2007 Section 4.2.8.5.

35. Time to Alarm for High Heart Rate

The time to alarm for a step change in heart rate from 80 BPM to 120 BPM, with the upper alarm limit set closest to 100 BPM, does not exceed 10 seconds.

36. Tall T-Wave Rejection

Tall T-wave rejection is as per ANSI/AAMI EC13:2002/(R)2007 Section 4.1.2.1 (c). The heart rate meter rejects all T-waves with amplitudes less than 120% of a 1mV, 100 msec QRS, and a T wave duration of 180ms and a Q-T interval of 350 msec.

37. Response Time of Heart Rate Meter to Change in Heart Rate

The response time of the heart rate meter to change in heart rate is less than 10 seconds for step increase from 80 to 120 BPM and less than 10 seconds for step decrease from 80 to 40 BPM as per ANSI/AAMI EC13:2002/(R)2007 Section 4.1.2.1 (f).

38. Time to Alarm for Tachycardia

The alarm response time for tachycardia is less than 10 seconds as per section ANSI/AAMI EC13:2002/(R)2007 Section 4.1.2.1 (g).

39. Pacer Rejection

The pacer rejection is in accordance with ANSI/AAMI EC13:2002/(R)2007 Section 4.1.4; the heart rate meter rejects all pacer pulses of amplitude ± 2.0 mV to ± 700 mV and duration 0.1 msec to 2 msec with no tail.

When tested in accordance with ANSI/AAMI EC13:2002/(R)2007 Section 4.1.4, the 3/5/6 Lead ECG derived heart rate meter rejects all pacer pulses ± 2.0 mV to ± 700 mV and duration 0.1 msec to 2 msec with tails of less than 2 mV and with time constants from 4ms to 100ms.

Pacer pulse detector rejection of fast ECG signals: 50 V/s RTI when measured in accordance with ANSI/AAMI EC13:2002/(R)2007 Section 4.1.4.3.

40. Heart Rate Average

In compliance with the requirements in Clause 4.1.2.1 d) of ANSI/AAMI EC13:2002/(R)2007, the following method is used:

The average heart rate is calculated on the basis of the mean RR-interval of the last 16 beats, unless the heart rate calculated using the last 4 beats is less than or equal to 48, then this rate is used.

HR is updated on the display every second.

41. Response to Irregular Rhythm

In compliance with the requirements in Clause 4.1.2.1 e) of ANSI/AAMI EC13:2002/(R)2007, the indicated heart rate after 20 seconds of stabilization period is:

Ventricular bigeminy (3a): 80 BPM

Slow alternating ventricular bigeminy (3b): 60 BPM

Rapid alternating ventricular bigeminy (3c): 120 BPM

Bidirectional systoles (3d): 90 BPM

Accuracy for above is ± 3 BPM or $\pm 3\%$, whichever is greater.

42. Heart Rate Alarms

The VPS is equipped with High and Low heart rate alarms. Alarms can be triggered when measured rate is equal to or greater than the alarm setting.

High Alarm Limits:

Adult: 50 to 300 BPM in steps of 1 BPM, default 150 BPM

NOTE: If country configuration is France, default is 120 BPM.

Pediatric: 50 to 300 BPM in steps of 1 BPM, default 180 BPM

NOTE: If country configuration is France, default is 150 BPM.

Neonate: 50 to 350 BPM in steps of 1 BPM, default 200 BPM

NOTE: If country configuration is France, default is 175 BPM.

Low Alarm Limits:

Adult: 25 to 200 BPM in steps of 1 BPM, default 50 BPM

NOTE: If country configuration is France, default is 30 BPM.

Pediatric: 25 to 200 BPM in steps of 1 BPM, default 80 BPM

NOTE: If country configuration is France, default is 50 BPM.

Neonate: 25 to 200 BPM in steps of 1 BPM, default 90 BPM

NOTE: If country configuration is France, default is 70 BPM.

43. ST Segment Analysis Performance Requirements**TABLE 28-17**

ENABLING:	ADULT AND PEDIATRIC MODES ONLY
Absolute ST Deviation Range(3/5/6 Lead ECG):	-10.0 mm to + 10.0mm (-1000 μ V to + 1000 μ V RTI)
Resolution:	0.1 mm (10 μ V)
User Selectable ST Measurement Points:	40, 60 or 80 msec after the J point (heart rate independent) OR 60/80 Heart Rate Dependent
Default ST Measurement Point:	60/80 Heart Rate Dependent. (80 msec after the J point for heart rates \leq 120 BPM. 60 msec after the J point for heart rates >120 BPM.)
Default ISO Point: User Selectable ISO Point (3/5/6 Lead ECG):	- Located between the P and Q waves. - User adjustable from "R peak" - 10msec to "R peak" - 200 msec in 2 msec increments.
Default J Point: User Selectable J Point (3/5/6 Lead ECG):	End of the QRS complex User adjustable from "R peak" + 10msec to "R peak" + 200 msec in 2 msec increments
Excluded Beats:	Ventricular ectopic beats and ventricular paced beats are excluded from ST measurements.

TABLE 28-17 (Continued)

ENABLING:	ADULT AND PEDIATRIC MODES ONLY
Invalid ST: (3/5/6 lead modes):	ST data shall be invalidated under the following conditions: If Ventricular Paced Rhythm, Ventricular Rhythm or Ventricular Tachycardia persists for more than 45 seconds and/or during detected episodes of Asystole and Ventricular Fibrillation. Invalid ST deviation data displayed as invalid (- -)

44. ST deviation Alarms

System is equipped with ST deviation alarms. ST deviation alarms trigger if the measured deviation is equal to or greater than the alarm setting for the appropriate lead. Single ST & Dual ST deviation Alarms Limits:

(For Adult, Pediatric)

TABLE 28-18

ST Single Lead High Alarm:	+0.5 to +10.0 mm in steps of 0.1 mm, default: Off
ST Single Lead Low Alarm:	-0.5 to -10.0 mm in steps of 0.1 mm, default: Off
ST Dual Lead High Alarm:	+0.5 to +10.0 mm in steps of 0.1 mm, default: Off
ST Dual Lead Low Alarm:	-0.5 to -10.0 mm in steps of 0.1 mm, default: Off

45. Arrhythmia Analysis

Arrhythmia analysis is disabled in neonatal mode. Non-lethal or all arrhythmia alarms can be disabled. The ECG module has ability to make following calls as applicable per ECG source:

- Asystole
- Bigeminy
- Bradycardia
- Couplet
- Irregular Heart Rate
- Multiform PVC
- Pause
- Pauses/Minute
- R-On-T PVCs
- PVCs/Minute
- Run
- Trigeminy
- Ventricular Fibrillation
- Ventricular Rhythm
- Ventricular Tachycardia

B. 12 Lead ECG

- The 12 Lead ECG functions in conjunction with the VPS.

1. Lead Definition

TABLE 28-19

ECG TYPE	ACQUIRED LEADS	DISPLAYABLE LEADS
12 Lead ECG	I, II, V1, V2, V3, V4, V5, V6	I, II, III, aVR, aVL, aVF, V1, V2, V3, V4, V5, V6

2. 12 Lead ECG Cable Detection

The ECG System has a manual selection for 12 Lead cables when Mindray cables are used.

3. Defibrillator Overload protection

The ECG function is in accordance with the applicable requirements of EN 60601-2-27 and EN 60601-2-25.

4. Recovery

ECG System recovers automatically from defibrillator overload as per ANSI/AAMI EC11: 1991/(R) 2007 within 8 seconds. Monitor recovers automatically from defibrillator overload as per ANSI/AAMI EC13:2002/(R)2007 within 5 seconds.

5. AC Overload Protection

AC overload protection withstands 60Hz, 1V p-p for 10 seconds in accordance with applicable requirements of ANSI/AAMI EC13:2002/(R)2007 and ANSI/AAMI EC11: 1991/(R) 2007.

6. ESU Protection

The 12 Lead ECG does not provide ESU protection or suppression.

7. Electro Surgical Unit Noise Suppression

The 12 Lead ECG does not provide ESU protection or suppression.

8. ESU Withstand

The 12 Lead ECG function is not required to provide ESU protection or suppression.

9. Input Impedance

Single ended input impedance of ECG System is greater than 2.5M Ω as per ANSI/AAMI EC13:2002/(R)2007, 4.2.9.2 and ANSI/AAMI EC11: 1991/(R) 2007, 3.2.9.

10. Lead Fault

Lead resistances $\leq 51K \Omega$ in parallel with 0.047 μ F capacitance unable to cause a lead fault condition. Differential offsets $\pm 300mV$ unable to cause a lead fault condition.

11. System Noise

System noise is less than 30 μ V p-p, referred to input, through shielded 51K Ω resistors in parallel with 47nF capacitors (ANSI/AAMI EC13:2002/(R)2007, 4.2.9.3 or ANSI/AAMI EC11: 1991/(R) 2007, 3.2.12).

12. Overall System Error

Overall system error is 5% or 40 μ V, whichever is greater (ANSI/AAMI EC13:2002/(R)2007, 4.2.9.8 or ANSI/AAMI EC11: 1991/(R) 2007, 3.2.7).

13. Gain Stability

The gain change one minute after energizing does not exceed 0.66 percent per minute. The total change in one hour does not exceed ± 10 percent of any available fixed gain setting. (ANSI/AAMI EC13:2002/(R)2007, 4.2.9.5 (d) or ANSI/AAMI EC11: 1991/(R) 2007, 3.2.4.4).

14. Multichannel Crosstalk

Multichannel crosstalk is a maximum of 2%, per (ANSI/AAMI EC13:2002/(R)2007, 4.2.9.4 or ANSI/AAMI EC11: 1991/(R) 2007, 3.2.12.2).

15. Baseline Stability

Baseline stability is as per (ANSI/AAMI EC13:2002/(R)2007, 4.2.9.11 (b) or ANSI/AAMI EC11: 1991/(R) 2007, 3.2.13.2).

16. Frequency Response**TABLE 28-20**

ECG Type	Bandwidth (-3db)		
	Monitor	Diagnostic	ST
12 Lead ECG	0.5 to 40 Hz	0.05 to 150 Hz	0.05 to 40 Hz

17. Impulse response

Impulse response is as per (ANSI/AAMI EC13:2002/(R)2007, 4.2.9.8 (c) or ANSI/AAMI EC11: 1991/(R) 2007, 3.2.7.2 (a), (b), Method A, D).

18. Notch Filter Selection

ECG System is equipped with 50 Hz or 60 Hz notch filter with option to turn off.

19. CMMR

CMMR is as per (ANSI/AAMI EC13:2002/(R)2007, 4.2.9.10 or ANSI/AAMI EC11: 1991/(R) 2007, 3.2.11). Notch filter is turned off.

20. Pacer Enhancement

Pacer signals within the range $\pm 2\text{mV}$ and $\pm 700\text{mV}$ (RTI) amplitude with a maximum rise time of 100usec and with duration in the 0.1ms to 2.0ms range are enhanced on the display when the Pacer Enhancement Mode is turned ON.

21. Pacer Rejection

Pacer signals from $\pm 2\text{mV}$ to $\pm 700\text{mV}$ (RTI) amplitude and 0.1ms to 2ms in duration, and a maximum of 100 μs rise time are rejected from the display when the Pacer Rejection Mode is ON.

22. ESIS Filtering

The 12 Lead ECG does not provide ESU protection or suppression.

23. ESU Noise Detection

The 12 Lead ECG does not provide ESU protection or suppression.

24. ECG Heart Rate Meter

The ECG heart rate meter function is derived from the ECG waveform.

Range:

TABLE 28-21

ECG Source:	Neonatal Range (BPM)	Pediatric Range: (BPM)	Adult Range: (BPM)
12 Lead ECG	30 to 300	30 to 300	30 to 300

25. Resolution

Resolution is 1 BPM.

26. Accuracy

Accuracy is ± 3 BPM or $\pm 3\%$ from 30 to 250 BPM, $\pm 5\%$ in the 251 to 300 BPM range.

27. Out of Range

For values outside the specified measurement range, the heart rate meter indicates invalid data as (- -).

28. Trigger Indication

There is an audible beep on every beat captured, if enabled.

29. Trigger Threshold

Heart rate meter does not trigger on signals having a QRS amplitude of 0.2 mV or less, or a duration of 10 msec or less with an amplitude of 1mv (ANSI/AAMI EC13:2002/(R)2007, 4.2.6.1) in ADULT mode only.

30. Detectable QRS Width

70 to 120 msec, minimum for Adults and 40 to 120 msec, minimum, for Pediatric and Neonate patients as per ANSI/AAMI EC13:2002/(R)2007, 4.2.6.1.

31. 60 Hz Voltage Tolerance

Heart rate meter is able to tolerate 60 Hz sinusoidal voltage less than or equal to 100 μ V p-p RTI as per ANSI/AAMI EC13:2002/(R)2007, 4.2.6.2.

32. Drift Tolerance

Heart rate meter is able to tolerate triangular wave of 0.1 Hz, 4mV p-p RTI superimposed on ECG per ANSI/AAMI EC13:2002/(R)2007, 4.2.6.3.

33. Time to Alarm for Cardiac Standstill

The time to alarm for a step change in heart rate from 80 BPM to 0 BPM, with lower alarm limit set to closest to 60 BPM does not exceed 10 seconds as per ANSI/AAMI EC13:2002/(R)2007 Section 4.2.8.4.

34. Time to Alarm for Low Heart Rate

The time to alarm for a step change in heart rate from 80 BPM to 40 BPM, with lower alarm limit set to closest to 60 BPM, does not exceed 10 seconds as per ANSI/AAMI EC13:2002/(R)2007 Section 4.2.8.5.

35. Time to Alarm for High Heart Rate

The time to alarm for a step change in heart rate from 80 BPM to 120 BPM, with the upper alarm limit set closest to 100 BPM, does not exceed 10 seconds.

36. Tall T-Wave Rejection

Tall T-wave rejection is as per ANSI/AAMI EC13:2002/(R)2007 Section 4.1.2.1 (c). The heart rate meter rejects all T-waves with amplitudes less than 120% of a 1mV, 100 msec QRS, and a T wave duration of 180ms and a Q-T interval of 350 msec.

37. Response Time of Heart Rate Meter to Change in Heart Rate

The response time of the heart rate meter to change in heart rate is less than 10 seconds for step increase from 80 to 120 BPM and less than 10 seconds for step decrease from 80 to 40 BPM as per ANSI/AAMI EC13:2002/(R)2007 Section 4.1.2.1 (f).

38. Time to Alarm for Tachycardia

The alarm response time for tachycardia is less than 10 seconds as per section ANSI/AAMI EC13:2002/(R)2007 Section 4.1.2.1(g).

39. Pacer Rejection

The pacer rejection is in accordance with ANSI/AAMI EC13:2002/(R)2007 Section 4.1.4; the heart rate meter rejects all pacer pulses of amplitude ± 2.0 mV to ± 700 mV and duration 0.1 msec to 2 msec with no tail.

When tested in accordance with ANSI/AAMI EC13:2002/(R)2007 Section 4.1.4, the 12 Lead ECG derived heart rate meter rejects all pacer pulses ± 2.0 mV to ± 700 mV and duration 0.1 msec to 2 msec with tails of less than 2 mV and with time constants from 4ms to 100ms.

Pacer pulse detector rejection of fast ECG signals: 50 V/s RTI when measured in accordance with ANSI/AAMI EC13:2002/(R)2007 Section 4.1.4.3.

40. Heart Rate Average

In compliance with the requirements in Clause 4.1.2.1 d) of ANSI/AAMI EC13:2002/(R)2007, the following method is used:

The average heart rate is calculated on the basis of the mean RR-interval of the last 16 beats, unless the heart rate calculated using the last 4 beats is less than or equal to 48, then this rate is used. HR is updated on the display every second.

41. Response to Irregular Rhythm

In compliance with the requirements in Clause 4.1.2.1 e) of ANSI/AAMI EC13:2002/(R)2007, the indicated heart rate after 20 seconds of stabilization period is:

Ventricular bigeminy (3a): 80 BPM

Slow alternating ventricular bigeminy (3b): 60 BPM

Rapid alternating ventricular bigeminy (3c): 120 BPM

Bidirectional systoles (3d): 90 BPM

Accuracy for above is ± 3 BPM or $\pm 3\%$, whichever is greater.

42. Heart Rate Alarms

The 12 Lead ECG is equipped with High and Low heart rate alarms. Alarms can be triggered when measured rate is equal to or greater than the alarm setting.

High Alarm Limits:

Adult:	50 to 300 BPM in steps of 1 BPM, default 150 BPM Note: If country configuration is France, default is 120 BPM
Pediatric:	50 to 300 BPM in steps of 1 BPM, default 180 BPM Note: If country configuration is France, default is 150 BPM
Neonate:	50 to 350 BPM in steps of 1 BPM, default 200 BPM Note: If country configuration is France, default is 175 BPM

Low Alarm Limits:

Adult:	25 to 200 BPM in steps of 1 BPM, default 50 BPM Note: If country configuration is France, default is 30 BPM
Pediatric:	25 to 200 BPM in steps of 1 BPM, default 80 BPM Note: If country configuration is France, default is 50 BPM
Neonate:	25 to 200 BPM in steps of 1 BPM, default 90 BPM Note: If country configuration is France, default is 70 BPM

43. ST Segment Analysis Performance Requirements

TABLE 28-22

ENABLING:	ADULT AND PEDIATRIC MODES ONLY.
Absolute ST Deviation Range(12 Lead ECG):	-10.0 mm to + 10.0mm (-1000 μ V to + 1000 μ V RTI)
Resolution:	0.1 mm (10 μ V).
User Selectable ST Measurement Points:	40, 60 or 80 msec after the J point (heart rate independent) OR 60/80 Heart Rate Dependent.
Default ST Measurement Point:	60/80 Heart Rate Dependent. (80 msec after the J point for heart rates \pm 120 BPM. 60 msec after the J point for heart rates >120 BPM.)
Default ISO Point: User Selectable ISO Point (12 Lead ECG):	- Located between the P and Q waves. - User adjustable from "R peak" - 10msec to "R peak" - 200msec in 2 msec increments.
Default J Point: User Selectable J Point (12 Lead ECG):	End of the QRS complex. User adjustable from "R peak" + 10msec to "R peak" + 200msec in 2 msec increments.
Excluded Beats:	Ventricular ectopic beats and ventricular paced beats are excluded from ST measurements.
Invalid ST: (12 Lead modes):	ST data shall be invalidated under the following conditions: If Ventricular Paced Rhythm, Ventricular Rhythm or Ventricular Tachycardia persists for more than 45 seconds and/or during detected episodes of Asystole and Ventricular Fibrillation. Invalid ST deviation data displayed as invalid (- -)

44. ST deviation Alarms

System is equipped with ST deviation alarms. ST deviation alarms trigger if the measured deviation is equal to or greater than the alarm setting for the appropriate lead. Single ST & Dual ST deviation Alarms Limits:

(For Adult, Pediatric)

TABLE 28-23

ST Single Lead High Alarm:	+0.5 to +10.0 mm in steps of 0.1 mm, default: Off
ST Single Lead Low Alarm:	-0.5 to -10.0 mm in steps of 0.1 mm, default: Off
ST Dual Lead High Alarm:	+0.5 to +10.0 mm in steps of 0.1 mm, default: Off
ST Dual Lead Low Alarm:	-0.5 to -10.0 mm in steps of 0.1 mm, default: Off

45. Arrhythmia Analysis

Arrhythmia analysis is disabled in neonatal mode. Non-lethal or all arrhythmia alarms can be disabled. The ECG module has ability to make following calls as applicable per ECG source:

- Asystole
- Bigeminy
- Bradycardia
- Couplet
- Irregular Heart Rate
- Multiform PVC
- Pause
- Pause/Minute
- R-On-T PVCs
- PVCs/Minute
- Run
- Trigeminy
- Ventricular Fibrillation
- Ventricular Rhythm
- Ventricular Tachycardia

28.2 Impedance Respiration

V 12/V 21 in conjunction with:

A. VPS for impedance respiration

1. Performance:

TABLE 28-24

Sensing Lead:	Lead II or I
Default Sensing Lead:	Lead II
Source:	When using a 3-Lead, 5-Lead, 6-Lead, the respiration system acquires respiration via the ECG leads.
Range:	ECG Respiration parameter range is 4 RPM to 199 RPM.
Respiration Rate Out of Range:	The respiration rate counter indicates invalid (-) for values outside specified range.
Accuracy:	ECG Respiration parameter accuracy is greater of ± 2 RPM or 2% of the signal value within the range of 4 to 150 RPM. ECG Respiration parameter accuracy is $\pm 4\%$ of the signal value within the range of 151 to 199 RPM.
Excitation Frequency:	38.4 kHz
Excitation Current:	< 384 μ A RMS max
Bandwidth:	0.1 Hz to 3 Hz (-3 dB) for adults 0.2 Hz to 3 Hz (-3 dB) for pediatric and neonatal patients
Baseline Impedance Range:	200 Ω to 2000 Ω at patient with 1k resistor in the ECG cable.
High Impedance Indication:	Greater than 2.2 k Ω at patient.
User Selectable Scale:	Five (5) gains are provided.
Linear Signal Range:	8 Ω p-p minimum.
Noise:	Less than 0.05 Ω at 500 Ω patient impedance, using a Mindray ECG cable.
Min. Breath Height Detected:	It is function of respiration scale. Waveform needs to be Greater than 0.1 Ω in order for breathes to be accurately detected.
Cardiovascular Artifact Rejection:	Detected by algorithm.

2. Respiration Alarms

Respiration function includes High and Low respiration rate alarms. Alarms can be triggered when measured rate is equal to or greater than the alarm setting.

High Alarm Limits:

Adult: 10 to 190 RPM in steps of 1 RPM, default Off

Pediatric: 10 to 190 RPM in steps of 1 RPM, default Off

Neonate: 10 to 190 RPM in steps of 1 RPM, default Off

Low Alarm Limits:

Adult: 5 to 50 RPM in steps of 1 RPM, default Off
 Pediatric: 5 to 50 RPM in steps of 1 RPM, default Off
 Neonate: 5 to 50 RPM in steps of 1 RPM, default Off

Apnea Alarm Delay:

Adult: 10 to 60 seconds adjustable in steps of 1 second, default 30 sec
 Pediatric: 10 to 20 seconds adjustable in steps of 1 second, default 15 sec
 Neonate: 10 to 20 seconds adjustable in steps of 1 second, default 15 sec

V 12/V 21 in conjunction with:

B. 12 Lead ECG for impedance respiration**1. Performance:****TABLE 28-25**

Sensing Lead:	Lead II or I
Default Sensing Lead:	Lead II
Source:	When using a 12 Lead the respiration system acquires respiration via the ECG leads.
Range:	ECG Respiration parameter range is 4 RPM to 199 RPM.
Respiration Rate Out of Range:	The respiration rate counter indicates invalid (-) for values outside specified range.
Accuracy:	ECG Respiration parameter accuracy is greater of ± 2 RPM or 2% of the signal value within the range of 4 to 150 RPM. ECG Respiration parameter accuracy is $\pm 4\%$ of the signal value within the range of 151 to 199 RPM.
Excitation Frequency:	38.4 kHz
Excitation Current:	< 384 μ A RMS max
Bandwidth:	0.1 Hz to 3 Hz (-3 dB) for adults 0.2 Hz to 3 Hz (-3 dB) for pediatric and neonatal patients
Baseline Impedence Range:	200 Ω to 2000 Ω at patient with 1k resistor in the ECG cable.
High Impedance Indication:	Greater than 2.2 k Ω at patient.
User Selectable Scale:	Five (5) gains are provided.
Linear Signal Range:	8 Ω p-p minimum.
Noise:	Less than 0.05 Ω at 500 Ω patient impedance, using a Mindray ECG cable.
Min. Breath Height Detected:	It is function of respiration scale. Waveform needs to be Greater than 0.1 Ω in order for breathes to be accurately detected.
Cardiovascular Artifact Rejection:	Detected by algorithm.

2. Respiration Alarms

Respiration function includes High and Low respiration rate alarms. Alarms can be triggered when measured rate is equal to or greater than the alarm setting.

High Alarm Limits:

Adult: 10 to 190 RPM in steps of 1 RPM, default Off

Pediatric: 10 to 190 RPM in steps of 1 RPM, default Off

Neonate: 10 to 190 RPM in steps of 1 RPM, default Off

Low Alarm Limits:

Adult: 5 to 50 RPM in steps of 1 RPM, default Off

Pediatric: 5 to 50 RPM in steps of 1 RPM, default Off

Neonate: 5 to 50 RPM in steps of 1 RPM, default Off

Apnea Alarm Delay:

Adult: 10 to 60 seconds adjustable in steps of 1 second, default 30 sec

Pediatric: 10 to 20 seconds adjustable in steps of 1 second, default 15 sec

Neonate: 10 to 20 seconds adjustable in steps of 1 second, default 15 sec

28.3 Non-Invasive Blood Pressure (NIBP)

The NIBP function is in accordance with the requirements of EN 60601-2-30, EN 1060-1, EN 1060-3, and SP 10.

NOTE: This equipment is suitable for use in the presence of electrosurgery.

V 12/V 21 in conjunction with:

- VPS

1. NIBP Maximum Cuff Pressure

TABLE 28-26

MODE	SOFTWARE CONTROL MAXIMUM CUFF PRESSURE IN MMHG	HARDWARE CONTROL MAXIMUM CUFF PRESSURE IN MMHG
Adult	295	330
Pediatric	190	220
Neonate	145	165

2. NIBP Cuff Inflation

The inflation source is capable of supplying sufficient air to bring a volume of 200 cc to a pressure of 300 mmHg in no more than 10 seconds (Reference ANSI/AAMI SP10-2002). If the cuff is not inflated to the needed pressure within 60 seconds then the cuff is vented and a retry cycle is initiated up to 3 times.

3. NIBP Maximum Leakage

The maximum allowed pressure drop with the bleed valves closed is 1 mmHg in 10 seconds as measured with a 200 cc volume at differential pressures of 250 mmHg, 150 mmHg and 50 mmHg (Reference ANSI/AAMI SP10-2002, EN1060-3, 1997).

4. NIBP Vent Rate

System can vent a volume of 500 cc, from a pressure of 260 mmHg to a pressure of 15 mmHg in a maximum of 10 seconds. In the Neonate patient mode, system can vent a volume of 100 cc, from a pressure of 150 mmHg to a pressure of 5 mmHg in less than 5 seconds (Reference: EN1060-3, 1997, ANSI/AAMI SP10-2002).

5. NIBP Systolic Pressure

Accuracy:	Mean error ± 5 mmHg
Standard Deviation:	less than 8 mmHg
Measurement Range:	Adult Mode: 55 to 235 mmHg Pediatric Mode: 55 to 160 mmHg Neonate Mode: 45 to 120 mmHg
Resolution:	1 mmHg

6. NIBP Systolic Pressure Alarms

NIBP system is equipped with High and Low NIBP rate alarms. Alarms can be triggered when measured rate is equal to or greater than the alarm setting.

High Alarm Limits:

Adult:	40 to 240 mmHg in steps of 1 mmHg, default: Off
Pediatric:	30 to 140 mmHg in steps of 1 mmHg, default: Off
Neonate:	30 to 100 mmHg in steps of 1 mmHg, default: Off

Low Alarm Limits:

Adult:	30 to 150 mmHg in steps of 1 mmHg, default: Off
Pediatric:	30 to 120 mmHg in steps of 1 mmHg, default: Off
Neonate:	20 to 90 mmHg in steps of 1 mmHg, default: Off

7. NIBP Diastolic Pressure

Accuracy:	Mean error ± 5 mmHg
Standard Deviation:	less than 8 mmHg
Measurement Range: Hg	Adult Mode: 30 to 200 mmHg Pediatric Mode: 30 to 150 mmHg Neonate Mode: 20 to 100 mmHg
Resolution:	1 mmHg

8. NIBP Diastolic Pressure Alarms

NIBP system is equipped with High and Low NIBP rate alarms. Alarms can be triggered when measured rate is equal to or greater than the alarm setting.

High Alarm Limits:

Adult:	40 to 150 mmHg in steps of 1 mmHg, default: Off
Pediatric:	30 to 120 mmHg in steps of 1 mmHg, default: Off
Neonate:	30 to 90 mmHg in steps of 1 mmHg, default: Off

Low Alarm Limits:

Adult:	20 to 140 mmHg in steps of 1 mmHg, default: Off
Pediatric:	20 to 100 mmHg in steps of 1 mmHg, default: Off
Neonate:	10 to 80 mmHg in steps of 1 mmHg, default: Off

9. NIBP Mean Alarms

NIBP system is equipped with High and Low NIBP rate alarms. Alarms can be triggered when measured rate is equal to or greater than the alarm setting.

High Alarm Limits:

Adult:	60 to 200 mmHg in steps of 1 mmHg, default: Off
Pediatric:	30 to 140 mmHg in steps of 1 mmHg, default: Off
Neonate:	30 to 90 mmHg in steps of 1 mmHg, default: Off

Low Alarm Limits:

Adult:	20 to 150 mmHg in steps of 1 mmHg, default: Off
Pediatric:	20 to 100 mmHg in steps of 1 mmHg, default: Off
Neonate:	10 to 70 mmHg in steps of 1 mmHg, default: Off

NOTE: **Mean Arterial Pressure (MAP) is defined as:**
Mean Pressure 1 = Mean Pressure determined from the oscillometric profile
Mean Pressure 2 = (2 × diastolic + systolic) / 3
Mean Pressure Displayed = (Mean Pressure 1 + Mean Pressure 2) / 2

10. NIBP Static Pressure:

Accuracy:	±3 mmHg
Range:	0 to 300 mmHg

11. NIBP Heart Rate:

Accuracy:	Greater of ± 3 BPM or ± 3%
Resolution:	1 BPM
Measurement Range:	Adult Mode:35 to 245 BPM Pediatric Mode:35 to 245 BPM Neonate Mode:70 to 245 BPM
Invalid Data:	Invalid NIBP Heart Rate data displayed as (- -).

12. NIBP Start Pressure Settings and Ranges

The Start Pressure is adjustable throughout the following ranges and set to the following defaults:

TABLE 28-27

PATIENT SETTING	START PRESSURE RANGE	INCREMENT SIZE	DEFAULT SETTING
Adult Mode	100-280 mmHg	1 mmHg	180 mmHg
Pediatric Mode	60-180 mmHg	1 mmHg	140 mmHg
Neonatal Mode	40-120 mmHg	1 mmHg	100 mmHg

13. NIBP Measurement Cycle

NIBP System has three different modes of measurement:

Manual Mode:	It requires operator to initiate the measurement cycle.
Interval Mode:	In this mode NIBP System follows a configured plan of automatically initiated measurement cycles. NIBP System supports Off, 1 min, 2 min, 3 min, 5 min, 10 min, 15 min, 20 min, 30 min, 1 hr, 2 hrs, 4 hrs intervals.
STAT Measurement Mode:	Once STAT mode is selected, NIBP system performs a series of blood pressure measurements for five (5) minutes or 10 measurements. As soon as a measurement is completed, the next one starts with pause of 2 seconds between measurements. (Reference: EN60601-2-30, 2000)

The Maximum Measurement Cycle Duration is 180 sec for Adult and Pediatric patients (Reference: EN60601-2-30, 2000).

The Maximum Measurement Cycle Duration is 90 sec for Neonatal patients (Reference: EN60601-2-30, 2000).

28.4 Invasive Blood Pressure (IBP)

V 12/V 21 in conjunction with:

- VPS or IBP module

1. Performance:

Accuracy: ± 2 mm Hg or 2% of the signal value which ever is greater (excluding transducer error).

Resolution: 1 mmHg

2. IBP Transducer:

Excitation: 5 Volts DC, $\pm 2\%$

Minimum Load resistance: 300 ohms per transducer.

Transfer Function: Compatible with $5\mu\text{V}/\text{mmHg}/\text{Volt}$ nominal excitation transducers

Zero Offset Range: The transducer zero offset range is ± 120 mmHg.

Zero Accuracy: The zero accuracy is ± 4 mmHg.

Linear Input Range: -30 to +300 mmHg, after zeroing.

Noise: <0.5 mmHg RTI, 300 Ω source impedance.

Drift: <0.15 mmHg per degree Celsius.

Frequency Response: 8Hz ± 1 Hz, 12Hz ± 1 Hz, 16 Hz ± 1 Hz, (-3db Point)

Invalid Data: Invalid IBP data displayed as (- -).

Transducer not zeroed or

Uncalibrated: The blood pressure indication is XX when the transducer is not zeroed or uncalibrated.

3. IBP Alarm Limits

IBP system is equipped with High and Low IBP alarms. Alarms can be triggered when measured rate is equal to or greater than the alarm setting.

Systolic Pressure High Alarm Limits:

Adult: 5 to 300 mmHg in steps of 1 mmHg, default: Off

Pediatric: 5 to 300 mmHg in steps of 1 mmHg, default: Off

Neonate: 5 to 300 mmHg in steps of 1 mmHg, default: Off

Systolic Pressure Low Alarm Limits:

Adult: 0 to 150 mmHg in steps of 1 mmHg, default: Off

Pediatric: 0 to 150 mmHg in steps of 1 mmHg, default: Off

Neonate: 0 to 150 mmHg in steps of 1 mmHg, default: Off

Diastolic Pressure High Alarm Limits:

Adult:	5 to 200 mmHg in steps of 1 mmHg, default: Off
Pediatric:	5 to 200 mmHg in steps of 1 mmHg, default: Off
Neonate:	5 to 200 mmHg in steps of 1 mmHg, default: Off

Diastolic Pressure Low Alarm Limits:

Adult:	0 to 150 mmHg in steps of 1 mmHg, default: Off
Pediatric:	0 to 150 mmHg in steps of 1 mmHg, default: Off
Neonate:	0 to 150 mmHg in steps of 1 mmHg, default: Off

Mean Pressure High Alarm Limits:

Adult:	5 to 200 mmHg in steps of 1 mmHg, default: Off
Pediatric:	5 to 200 mmHg in steps of 1 mmHg, default: Off
Neonate:	5 to 200 mmHg in steps of 1 mmHg, default: Off

Mean Pressure Low Alarm Limits:

Adult:	0 to 150 mmHg in steps of 1 mmHg, default: Off
Pediatric:	0 to 150 mmHg in steps of 1 mmHg, default: Off
Neonate:	0 to 150 mmHg in steps of 1 mmHg, default: Off

4. IBP Heart Rate

Range:	Adult Mode:30 to 300 BPM Pediatric Mode:30 to 300 BPM Neonate Mode: 30 to 350 BPM
Invalid Data:	Invalid IBP Heart Rate data displayed as (- -).
Resolution:	1 BPM
Accuracy:	± 3 BPM or $\pm 3\%$ at 30 to 250 BPM ± 5 BPM or $\pm 5\%$ from 251 to 350 BPM

28.5 Temperature

V 12/V 21 in conjunction with:

- VPS or Temp module

1. Performance:

Scale:	Selectable, Celsius or Fahrenheit
Range:	15°C to 45°C, inclusive 59°F to 113°F, inclusive
Invalid Data:	Invalid Temperature data displayed as (- -).
Resolution:	0.1°C, 0.1°F
Accuracy:	± 0.1°C (15°C - 45°C), exclusive of probe errors ± 0.2°F (59°F - 113°F), exclusive of probe errors
Accuracy 400 Series Probes:	± 0.1°C (25°C - 45°C) ± 0.2°C (otherwise) ± 0.2°F (77°F - 113°F) ± 0.4°F (otherwise)
Probe Excitation: 400 series-	<200µA, Thermister to Ground.
Delta Temperature range:	0°C to 10.0°C 0°F to 10.0°F
Delta T Resolution:	0.1°C 0.1°F

2. Temperature Alarms

The temperature function includes High and Low temperature alarms. Alarms can be triggered when measured temperature is equal to or greater than the alarm setting.

Temperature High Alarm Limits:

Adult:	25.0°C to 45.0°C in steps of 0.1°C, default Off 77.0°F to 113.0°F in steps of 0.1°F, default Off
Pediatric:	25.0°C to 45.0°C in steps of 0.1°C, default Off 77.0°F to 113.0°F in steps of 0.1°F, default Off
Neonate:	25.0°C to 45.0°C in steps of 0.1°C, default Off 77.0°F to 113.0°F in steps of 0.1°F, default Off

Temperature Low Alarm Limits:

Adult:	15.0°C to 40.0°C in steps of 0.1°C, default Off 59.0°F to 104.0°F in steps of 0.1°F, default Off
Pediatric:	15.0°C to 40.0°C in steps of 0.1°C, default Off 59.0°F to 104.0°F in steps of 0.1°F, default Off
Neonate:	15.0°C to 40.0°C in steps of 0.1°C, default Off 59.0°F to 104.0°F in steps of 0.1°F, default Off

Delta Temperature High Alarm Limits:

Adult:	0.0°C to 10.0°C in steps of 0.1°C, default Off 0.0°F to 10.0°F in steps of 0.1°F, default Off
Pediatric:	0.0°C to 10.0°C in steps of 0.1°C, default Off 0.0°F to 10.0°F in steps of 0.1°F, default Off
Neonate:	0.0°C to 10.0°C in steps of 0.1°C, default Off 0.0°F to 10.0°F in steps of 0.1°F, default Off

28.6 Pulse Oximetry (SpO₂)

V 12/V 21 in conjunction with:

A. VPS with Nellcor or Masimo

• SpO₂ Alarms

High Alarm Limits:

Adult:	75 to 101% in steps of 1%, default 101%
Pediatric:	75 to 101% in steps of 1%, default 101%
Neonate:	75 to 101% in steps of 1%, default 101%

Low Alarm Limits:

Adult:	70 to 99% in steps of 1%, default 88%
Pediatric:	70 to 99% in steps of 1%, default 90%
Neonate:	70 to 99% in steps of 1%, default 92%

B. VPS with Nellcor

1. Nellcor SpO₂ Sensor Compatibility

- OxiMax Adhesive Sensors: MAXAI, MAX-AL, MAXPI, MAXII, MAX-NI.
- OxiMax OxiCliq Sensors: OxiCliq A, OxiCliq P, OxiCliq I, OxiCliq N, OxiCliq Sensor Cable OC-3.
- OxiMax Reusable Sensors: DS-100A, D-YS, D-YSE, D-YSPD, Oxiband OXI-A/N, Oxiband OXI-P/I.

2. Nellcor SpO₂ Saturation Accuracy

SENSOR	ACCURACY
MAXAI, MAX-AL, MAXPI, MAXII, MAXNI (Adult), MAXNI (Neonate)	70% to 100% ± 2 digits
OxiCliq A, OxiCliq P, OxiCliq I, OxiCliq N (Adult), OxiCliq N (Neonate)	70% to 100% ± 2.5 digits
DS-100A, D-YS (Infant to Adult), OXI-A/N (Adult), OXI-P/I	70% to 100% ± 3 digits
D-YS with D-YSE Ear Clip, D-YS with D-YSPD Spot Clip	70% to 100% ± 3.5 digits
D-YS (Neonate), OXI-A/N (Neonate)	70% to 100% ± 4 digits

- SpO₂ parameter minimum range is 70% to 100%.
- Invalid SpO₂ parameter displayed as (- -).
- SpO₂ parameter display resolution is 1%.

3. Nellcor SpO₂ Performance Requirements

- Update Rate: Every 2 seconds

NOTE: The sensor wavelengths are nominal.

- 660 nm for the red LED and 890 nm for the infrared LED.
- Maximum optical power output for the LEDs is 4 mW.

4. Nellcor SpO₂ Heart Rate

For Adult, Pediatric, and Neonatal:

RANGE	ACCURACY
20 to 249 BPM	±3 BPM

- SpO₂ heart rate resolution is 1BPM.
- Invalid SpO₂ heart rate data displayed as (- -)

5. Nellcor Sat Seconds

- Indicates the current status of the alarm graphically within the pie-chart icon.
- Fills in a clockwise direction when the monitor detects the SpO₂ value is outside the set alarm limits.
- Empties in a counter-clockwise direction when the SpO₂ reading falls within the set alarm limits.

C. VPS with Masimo

1. Masimo SpO₂ Sensor Compatibility

- Masimo LNOP series and LNCS series

2. Masimo SpO₂ Saturation Accuracy

SENSOR	ACCURACY
The Pulse Oximetry Parameter accuracy (adult)	Maximum error of 2% with no motion
The Pulse Oximetry Parameter accuracy (adult)	Maximum error of 3% in the presence of motion with motion resistant sensors.
The Pulse Oximetry Parameter accuracy (pediatric)	Maximum error of 2% with no motion
The Pulse Oximetry Parameter accuracy (pediatric)	Maximum error of 3% in the presence of motion with motion resistant sensors.
The Pulse Oximetry Parameter accuracy (neonatal)	Maximum error of 3% with no motion
The Pulse Oximetry Parameter accuracy (neonatal)	Maximum error of 3% in the presence of motion with motion resistant sensors.

- SpO₂ parameter minimum range is 70% to 100%.
- Invalid SpO₂ parameter displayed as (- -).
- SpO₂ parameter display resolution is 1%.

3. Masimo SpO₂ Performance Requirements

- Update Rate: Every 2 seconds

NOTE: The sensor measurement wavelengths are nominally

- 660 nm for the red LED and 890 nm for the infrared LED.
- Maximum optical power output for the LEDs is 4 mW.

4. Masimo SpO₂ Heart Rate

For Adult, Pediatric, and Neonatal:

RANGE	ACCURACY
26 to 239 BPM	±3 BPM

- SpO₂ heart rate resolution is 1BPM.
- Invalid SpO₂ heart rate data displayed as (- -).

5. Masimo Perfusion Index

- Displays the PI resolution as 0.01% when 0 < PI < 10%
- Displays the PI resolution as 0.1% when 20% >= PI >= 10%

28.7 Analog Output

V 12/V 21 in conjunction with:

- VPS

1. ECG Interface

Bandwidth (-3 dB referenced to 10 Hz): 0.5 Hz to 100 Hz

Propagation Delay (Delay of QRS complex): Less than 25 msec

Sensitivity: 1 V/mV \pm 10% (referenced to 10 Hz).

Pacer Displayed with ECG lead: I,II

Pacer Enhancement: Pacer is summed at the output when Pacer enhancement mode is turned ON.

Pacer amplitude signal is a minimum of 2.5v.

Pacer width is 10 ms, with a 5% tolerance. (for single pacer only)

Pacer rise and fall times are 100 μ s, maximum.

2. IBP1 and IBP2 Interface

Bandwidth (-3 dB referenced to DC): DC to 15 Hz

Propagation Delay: Less than 25 msec

Sensitivity: 1 V/100 mmHg \pm 2%

3. Defibrillator Sync Interface

Maximum delay between the QRS peak and the rising edge of the defibrillator sync pulse: 35 msec

Minimum Output Amplitude: 2V into a 5 Kohm load

Output Pulse Width: 2 msec to 7 msec

28.8 Thermodulution Cardiac Output (CO)

The **V 12/V 21** in conjunction with:

- CO Module

1. Performance:

Range:	0.2 to 20.0 liters/minute
Range for Hospira:	1.0 to 20.0 liters/minute
Range for Edwards Life Science:	1.0 to 20.0 liters/minute
Resolution:	0.1 liters/minute
Accuracy:	5% or 0.2 liters/minute, whichever is greater
Repeatability:	+ 2% or 0.2 liters/minute, whichever is greater as measured by electronically generated flow curves.
Invalid Data:	Invalid data displayed as (- -)

2. Blood Temperature Measurement

Range:	17.5 to 43.0°C (63.5°F to 109.4°F)± 0.2°C (± 0.4°F)
Resolution:	0.1°C (0.1°F)
Accuracy:	± 0.2°C (± 0.4°F)(not including probe error)
Invalid Data:	Invalid data displayed as (--)
T-blood High Alarm: (For Adult and Pediatric)	35.0°C to 43.0°C in steps of 1°C, default Off (95.0°F to 110.0°F in steps of 1°F, default Off)
T-blood Low Alarm: (For Adult and Pediatric)	26.0°C to 38.0°C in steps of 1°C, default Off (80.0°F to 100.0°F in steps of 1°F, default Off)

3. Injectate Temperature Measurement

Range:	-1.0 to 30.0°C (30.2°F to 86.0°F)
Resolution:	0.1°C (0.1°F)
Accuracy:	Exclusive of probe errors:± 0.2°C (± 0.4°F)
Invalid Data:	Invalid data displayed as (- -).

28.9 Carbon Dioxide (CO₂)

The **V 12/V 21** in conjunction with:

- CO₂ Module with Oridion

1. Performance (at sea level)

CO₂ range is 0-99 mmHg, inclusive.

The **V 12/V 21** is equipped with automatic barometric pressure compensation.

2. Accuracy (at sea level)

Accuracy specification of the measured CO₂ partial pressure is according to the following table. This testing is done according to ISO 21647 clauses 51.101.1 and 51.101.2.

Accuracy in the presence of interfering gases:

TABLE 28-28

CO ₂ PARTIAL PRESSURE AT SEA LEVEL	ACCURACY
0-38 mmHg	± 2 mmHg
39-99 mmHg	± (5% of reading + 0.08% x (reading -39 mmHg))

NOTE: Accuracy applies for breath rates of up to 80 bpm. For breath rates above 80 bpm, accuracy is 4 mmHg or ± 12% of reading whichever is greater, for EtCO₂ values exceeding 18 mmHg. This is tested according to and is compliant with ISO 21647.

The accuracy specification is maintained to within 4% of the values indicated in TABLE 28-28 on page 28-41 in the presence of interfering gases according to ISO 21647 clauses 51.101.3 and 101.1. The accuracy specification is maintained to within 4% of the values indicated in the table above in the presence of up to 80% Helium with up to 15% oxygen when tested according to the procedures defined by ISO 21647.

Respiration Rate

Respiration Rate Range:	0 to 150 RPM
Flow Rate:	50 ml/min -7.5 + 15 ml/min, flow measured by volume
Respiration Rate Accuracy:	The respiration rate measurement accuracy is: 0 to 70 RPM ± 1 RPM 71 to 120 RPM ± 2 RPM 121 to 150 RPM ± 3 RPM
Invalid Data:	Invalid data displayed as (--).
CO ₂ Calibration Interval:	No routine calibration is required. The module should initially be calibrated after 1200 operating hours, then once a year or after 4,000 operating hours, whichever comes first.

System Response Time

System Response Time:	The system response time (with a standard-length FilterLine) which includes the delay time and rise time (10% to 90%) in response to a step change in the CO ₂ concentration is 2.9 seconds typical. Rise Time Adult and Neonatal: 190 mSec max. Delay Time: 4.9 seconds typical
-----------------------	--

Initialization Time

Before the module begins to measure CO₂, it completes self-test and initialization procedures required for proper operation.

CO₂ Reporting Resolution

The CO₂ reporting resolution is 0.1 mmHg.

Self-Maintenance (SFM) Interval

Self-Maintenance Interval (SFM):	<p>Self-Maintenance (SFM) is performed only during measurement mode. The module performs one or more of the following:</p> <ul style="list-style-type: none"> Ambient pressure measurement Auto zero (AZ) Flow test <p>SFM is triggered:</p> <ul style="list-style-type: none"> • During the first hour after entering measurement mode, periodically for durations of typically 10 seconds at a rate which limits the total time consumed by SFMs to less than 2% of the time in which active measurements are taken. Following the first hour after entering measurement mode, periodically for durations of typically 10 seconds at a rate of at most once per hour. • If a change of 8 °C from the last AZ is detected. • If pressure change of 20 mmHg relative to the last ambient pressure measurement (less than the purge threshold) for a period of 30 seconds is detected. The module will be able to detect a real change in the ambient pressure and a pressure change due to partial blockage of the FilterLine. • The module prevents the triggering of an SFM in the following situations: <ul style="list-style-type: none"> • In case of purging until the end of this state. • During a breath absence period which follows a valid breath. While waiting a minimum of 20 seconds for host SFM enable command. (After the 20-second opportunity given to the host to schedule the SFM passes, the module schedules the SFM according to a priority determined by current conditions).
----------------------------------	--

3. CO₂ Alarm Limits

The CO₂ module function includes High and Low CO₂ alarms. Alarms can be triggered when measured CO₂ is equal to or greater than the alarm setting.

ETCO₂ High Alarm Limits:

Adult:	<p>20 to 80 mmHg in steps of 1 mmHg, default: 60mmHg 2.0 to 10.0% in steps of 0.1%, default: 10% 2.0 to 10.0 kPa in steps of 0.1 kPa, default: 10 kPa</p>
Pediatric:	<p>20 to 80 mmHg in steps of 1 mmHg, default: 60 mmHg 2.0 to 10.0% in steps of 0.1%, default: 10% 2.0 to 10.0 kPa in steps of 0.1 kPa, default: 10 kPa</p>
Neonate:	<p>20 to 80 mmHg in steps of 1 mmHg, default: 60 mmHg 2.0 to 10.0% in steps of 0.1%, default: 10% 2.0 to 10.0 kPa in steps of 0.1 kPa, default: 10 kPa</p>

ETCO₂ Low Alarm Limits:

Adult:	5 to 50 mmHg in steps of 1 mmHg, default: 15mmHg, 1.0 to 6.0% in steps of 0.1%, default: 2%, 1.0 to 6.0 kPa in steps of 0.1 kPa, default: 2 kPa
Pediatric:	5 to 50 mmHg in steps of 1 mmHg, default: 15 mmHg 1.0 to 6.0% in steps of 0.1%, default: 2% 1.0 to 6.0 kPa in steps of 0.1 kPa, default: 2 kPa
Neonate:	5 to 50 mmHg in steps of 1 mmHg, default: 15 mmHg 1.0 to 6.0% in steps of 0.1%, default: 2% 1.0 to 6.0 kPa in steps of 0.1 kPa, default: 2 kPa

Inspired CO₂ High Alarm Limits:

Adult:	5 to 30 mmHg in steps of 1 mmHg, default: 10 mmHg 1.0 to 4.0% in steps of 0.1%, default: 1% 1.0 to 4.0 kPa in steps of 0.1 kPa, default: 0.1 kPa
Pediatric:	5 to 30 mmHg in steps of 1 mmHg, default: 10 mmHg 1.0 to 4.0% in steps of 0.1%, default: 1% 1.0 to 4.0 kPa in steps of 0.1 kPa, default: 0.1 kPa
Neonate:	5 to 30 mmHg in steps of 1 mmHg, default: 10 mmHg 1.0 to 4.0% in steps of 0.1%, default: 1% 1.0 to 4.0 kPa in steps of 0.1 kPa, default: 0.1 kPa

4. Respiration Alarm Limits

Refer to the alarms section "Impedance Respiration" on page 28-25, which includes apnea alarms.

28.10 Drug Calculations

The **V 12/V 21** has the ability to calculate and display intravenous (IV) drug infusion rate and concentration based upon patient weight and drug dosage in Adult mode only. The calculator calculates the following:

- Infusion Rate
- Concentration
- Titration Table
- Drug Dosage
- Review Previously Calculated Drug Calculations

28.11 Patient Contacting Materials

Following is a listing of patient contacting components of the V Series monitoring platform:

PATIENT CONTACTING COMPONENT

Handle

Front Bezel

Rear Housing

All patients contacting materials were found to be in compliance with the applicable parts of ISO 10991:2003, Biological Evaluations of Medical Devices.

28.12 Power Specifications

Power Supply Type

- AC power, battery
- Whole-system consumption: maximum of 215 W.

AC Mains Power Source

- AC power: 100~240 Vac, +/-10%
- Current: 2.4 - 1.0 Amps
- AC input power frequency: 60 Hz/50 Hz

Internal User-Removable Battery

- Li-Ion battery (0146-00-0091-01, Mindray)
- Number of batteries: 3 (maximum)

Li-Ion Battery Index

- Voltage: 11.1VDC
- Rated Battery capacity: 4.8 Ah (one battery)
- Battery run time: >240min (three batteries)

Operating conditions: 25°C for new fully-charged battery. Equipment configuration: 5-lead ECG, Impedance Respiration, Masimo SpO₂, Temperature, IBP1, IBP2, and NIBP in 15-min Interval mode.

Battery charge time:

- 3.5 hours for 90% charge and 5.5 hours for full charge (equipment powered off)
- 5.5 hours for 90% charge and 8.5 hours for full charge (equipment powered on)

28.13 Performance Characteristics

28.13.1 ECG Specifications

Regulations

Complies with the following regulations:

- ANSI/AAMI EC11:1991/(R) 2007
- EC13:2002/(R)2007*
- ANSI/AAMI EC57:1998 (R2003)
- IEC 60601-2-27:2005 / EN60601-2-27:2006
- IEC 60601-2-25:1993 + A1:1999 / EN60601-2-25:1995 + A1:1999
- * *Accuracy of input signal reproduction: Methods A & D were used, as prescribed in section 3.2.7.2 and 4.2.7.2 of this standard, to establish overall system error and frequency response. Because of the sampling characteristics and the asynchronism between sample rate and signal rate, the **V 12/V 21** may produce a noticeable modulating effect from one cycle to the next, particularly in pediatric recordings. * Heart Rate Meter Accuracy and Response to Irregular Rhythm: Ventricular bigeminy: 80 bpm; Slow alternating ventricular bigeminy: 60 bpm; Rapid alternating ventricular bigeminy: 120 bpm; Bidirectional systoles: 90 bpm. * Response time to HR change: From 80 to 120 bpm: less than 11 s; From 80 to 40 bpm: less than 11 s*
- * *Time to alarm for tachycardia: <11s (measured in accordance with EC 13 and IEC 60601-2-27)*

28.13.1.1 ECG Function and Specifications

Detection of Lead Sets

Detect 3, 5-lead, 6-lead, or 12-lead ECG lead according to ECG cable type configuration.

ECG Signal Range

- ± 5 mV (peak-to-peak value); the output accuracy of signals complies with 50.102.1 of IEC60601-2-27:2005.

Calibration Signal

- 1 mV (peak-to-peak value)
- Accuracy: 5% or 40 μ V, whichever is greater

Detected RTI Range of Measured ECG Signals

- 4.88 μ V, ± 8 mV when gain is $\times 0.125$, $\times 0.25$, $\times 0.5$, $\times 1$, $\times 2$, $\times 4$.

Input Impedance

- > 5 M ohms

Pace Pulse Rejection

- HR calculation rejects pulses with amplitude between ± 2 mV to ± 700 mV and width between 0.1 msec and 2 msec (no tails).

To enable about 50% pace pulses with fig.5d (EC13:2002/(R)2007, at page 28) waveforms to trigger pace pulse detector, the minimum input waveform change rate is 50 V/s RTI.

Sampling Speed

- 500 simple/s
- Accuracy: 1 μ V/LSB

28.13.1.2 ECG Specifications**Tall T waves Rejection**

- Complies with 4.1.2.1 c of ANSI/AAMI EC13:2002/(R)2007.

HR calculation is not affected for T-waves whose QRS complex is 100ms, QT interval is 350ms, lasting time is 180ms and amplitude less than 1.2mv.

28.13.2 Temperature Performance Characteristics

The **V 12/V 21** is capable of providing temperature measurements from three (3) channels for 400 series probe.

Measuring range: 15 - 45°C (59 -113°F)

Resolution: 0.1°C (0.1°F)

Scale: °C, °F

Tabular Trend: Yes

Graphic Trend: Yes

400 Series Probes:

Scale: Celsius or Fahrenheit

Range: 59°F to 113°F (15°C to 45°C)

Resolution: 0.1°C (0.1°F)

Accuracy: $\pm 0.1^\circ\text{C}$ (15°C - 45°C), exclusive of probe errors, $\pm 0.2^\circ\text{F}$ (59°F - 113°F), exclusive of probe errors

Accuracy inclusive of 400 Series probes:

$\pm 0.1^\circ\text{C}$ (25°C - 42°C), $\pm 0.2^\circ\text{C}$ (otherwise),

$\pm 0.2^\circ\text{F}$ (77°F - 108°F), $\pm 0.4^\circ\text{F}$ (otherwise)

Probe Excitation: < 200 μA , tip to sleeve.

The minimum measuring time required to obtain an accurate reading at the specified body site is probe-dependent and should be indicated on the probe Instructions For Use.

For each temperature probe, information about the proper environmental conditions of use, storage, and transport including temperature and humidity should be contained in the probe Instructions For Use.

28.13.3 Recorder Parameter Specifications**28.13.3.1 Recorder Safety Specifications**

The recorder module function is in accordance with the applicable requirements of IEC 60601-2-27 and IEC 60601-2-25.

28.13.3.2 Recorder Performance Specifications

The recorder can print physiological waveforms.

Recorder paper: 50mm wide spooled thermal strip chart paper, minimum 200 ft long, max diameter 50 mm when rolled.

Resolution: 600 dots per 25 mm at a print speed of 25mm/s, 400 dots at all other print speeds

Maximum traces: 3 traces on thermal strip chart paper

Printing speed:	5 printing speeds: 3.125, 6.25, 12.5, 25, and 50mm/sec, each within $\pm 5\%$
Paper installation:	Auto feed
Sensitivity:	$\pm 5\%$ on each trace
Performance:	EC11:1991/(R)2007, and EC13:2002/(R)2007

28.13.4 Continuous Cardiac Output (CCO) Performance Characteristics

The VDI module has capability to interface with Edwards Lifesciences Vigilance, Edwards Lifesciences Vigilance 2, Edwards Lifesciences Vigileo, and Edwards Lifesciences EV1000 in Adult and Pediatric Mode.

28.13.4.1 Continuous Cardiac Output Performance Requirements

Range:	1.0 liter/minute to 20.0 liters/minute
Resolution:	0.1 liters/minute
Accuracy:	0.2 liters/minute and 5%
Reproducibility:	greater of 0.1 liters/minute and $\pm 6\%$ (as measured by electronically generated flow curve)

28.13.4.2 Continuous Cardiac Index Performance Requirements

Range:	0.0 to 20.0 l/min/m ²
Resolution:	0.1 l/min/m ²

28.13.4.3 Real-time SVR Performance Requirements

Range:	0 to 3000 dynes-sec/cm ⁻⁵
Resolution:	1 dynes-sec/cm ⁻⁵

28.13.4.4 SVRI Performance Requirements

Range:	0 to 6000 dynes-sec/cm ⁵ /m ²
Resolution:	1 dynes-sec/cm ⁵ /m ²

28.13.4.5 SVO2 Output Performance Requirements

Range:	0% to 99%
Resolution:	1%
Accuracy:	$\pm 2\%$ at 30% to 99%

28.14 Safety Designations

28.14.1 Safety Classification

V 12 - Portable equipment intended for mobility.

V 21 - Stationary equipment

Type of Protection Against Electric Shock

V 12

Class II equipment.

Where the integrity of the external protective earth conductor arrangement is in doubt, equipment shall be operated from its internal electrical electric power source (battery).

V 21

Class II equipment.

Degree of Protection Against Electric Shock

- ECG/RESP/IBP/TEMP: CF, defibrillation-proof
- SpO₂/NIBP/CO₂: BF, defibrillation-proof

Protection Against Power Failure

Requirements of ISO21647: 2005: provides the device to prevent AC power from disconnection and tension of 10 Kg.

If the power supply is restored after interrupted, saved presets, user settings, and patient data previous to power failure are retained or can be restored with a storage device.

The monitor stores up to 43 hours of trend information (approximately 6000 trend items) when powered off. The interval for trend data is 1 minute.

If the power failure duration is equal to or greater than 120 seconds, then after recycling power to the monitor, the user defaults are reloaded.

If the power failure duration is less than 120 seconds, then after recycling power to monitor, the latest configuration is loaded automatically. These are the settings performed by users before power failure.

In the case of accidental power loss (removal of battery(ies) or AC), the system is equipped with an internal backup battery which prevents the system from shutting down if power is re-applied within 30 seconds. During the power loss period, the display shuts down and all the monitored parameters stop monitoring.

If power is restored within 30 seconds, the system re-establish all monitoring and connections that were available prior to the power loss. If power is not restored within 30 seconds, the system shuts down.

28.15 Electromagnetic Capability

28.15.1 EMC Safety

The **V 12/V 21** monitor needs special precautions regarding EMC and needs to be installed and put into service according to the EMC information in this Instructions For Use. Portable and mobile RF communications equipment can affect the **V 12/V 21** monitor.

The **V 12/V 21** is suitable for use in all establishments other than domestic establishments and those directly connected to the public low-voltage power supply network that supplies buildings used for domestic purposes.

Radiated Emission

Complies with the requirements of CISPR 11 (EN 55011:2007) Group 1, Class A.

Immunity Against Radiated Electromagnetic Fields

Complies with the requirements of IEC 61000-4-3:2001: 80 MHz to 2.5 GHz, 3V/m, 80% AM @ 2 Hz or modulation frequency significant for the equipment under test.

28.15.2 **V 12/V 21**

The **V 12/V 21** meets the requirements of IEC 60601-1-2/EN 60601-1-2.

NOTE: **The V 12/V 21 needs special precautions regarding EMC and needs to be installed and put into service according to the EMC information provided below.**

NOTE: **Portable and mobile RF communications equipment can affect the V 12/V 21. See tables 28-29 through 28-32 that follow.**

TABLE 28-29

GUIDANCE AND DECLARATION - ELECTROMAGNETIC EMISSIONS

The **V 12/V 21** is intended for use in the electromagnetic environment specified below. The customer or the user of the **V 12/V 21** should assure that it is used in such an environment.

EMISSIONS TEST	COMPLIANCE	ELECTROMAGNETIC ENVIRONMENT - GUIDANCE
RF emissions CISPR 11	Group 1	The V 12/V 21 uses RF energy only for its internal function. Therefore, its RF emissions are very low and are not likely to cause any interference in nearby electronic equipment.
RF emissions CISPR 11	Class A	The V 12/V 21 is suitable for use in all establishments other than domestic establishments and those directly connected to the public low-voltage power supply network that supplies buildings used for domestic purposes
Harmonic emissions IEC 61000-3-2	Class A	
Voltage fluctuations/ Flicker emissions IEC 61000-3-3	Complies	

TABLE 28-30

GUIDANCE AND DECLARATION - ELECTROMAGNETIC IMMUNITY

The **V 12/V 21** is intended for use in the electromagnetic environment specified below. The customer or the user of the **V 12/V 21** should assure that it is used in such an environment.

IMMUNITY TEST	IEC 60601 TEST LEVEL	COMPLIANCE LEVEL	ELECTROMAGNETIC ENVIRONMENT - GUIDANCE
Electrostatic discharge (ESD) IEC 61000-4-2	±6 kV contact ±8 kV air	±6 kV contact ±8 kV air	Floors should be wood, concrete or ceramic tile. If floors are covered with synthetic material, the relative humidity should be at least 30%.
Electrical fast transient/burst IEC 61000-4-4	±2 kV for power supply lines ±1 kV for input/output lines	±2 kV for power supply lines ±1 kV for input/output lines	Mains power quality should be that of a typical commercial or hospital environment.
Surge IEC 61000-4-5	±1 kV differential mode ±2 kV common mode	±1 kV differential mode ±2 kV common mode	Mains power quality should be that of a typical commercial or hospital environment.
Voltage dips, short interruptions and voltage variations on power supply input lines IEC 61000-4-11	<5% U_T (>95% dip in U_T) for 0.5 cycle 40% U_T (60% dip in U_T) for 5 cycles 70% U_T (30% dip in U_T) for 25 cycles <5% U_T (>95% dip in U_T) for 5 sec	<5% U_T (>95% dip in U_T) for 0.5 cycle 40% U_T (60% dip in U_T) for 5 cycles 70% U_T (30% dip in U_T) for 25 cycles <5% U_T (>95% dip in U_T) for 5 sec	Mains power quality should be that of a typical commercial or hospital environment. If the user of the V 12/V 21 requires continued operation during power mains interruptions, it is recommended that the V 12/V 21 be powered from an uninterruptible power supply or a battery.
Power frequency (50/60 Hz) magnetic field IEC 61000-4-8	3 A/m	3 A/m	Power frequency magnetic fields should be at levels characteristic of a typical location in a typical commercial or hospital environment.

U_T is the A.C. mains voltage prior to application of the test level.

TABLE 28-31

GUIDANCE AND DECLARATION - ELECTROMAGNETIC IMMUNITY

The **V 12/V 21** is intended for use in the electromagnetic environment specified below. The customer or the user of the **V 12/V 21** should assure that it is used in such an environment.

IMMUNITY TEST	IEC 60601 TEST LEVEL	COMPLIANCE LEVEL	ELECTROMAGNETIC ENVIRONMENT - GUIDANCE
			Portable and mobile RF communications equipment should be used no closer to any part of the V 12/V 21 , including cables, than the recommended separation distance calculated from the equation applicable to the frequency of the transmitter.
			Recommended separation distance
Conducted RF IEC 61000-4-6	3 Vrms 150 kHz to 80 MHz	3 Vrms	$d = 1.2 \times \sqrt{P}$
Radiated RF IEC 61000-4-3	3 V/m 80 MHz to 2.5 GHz	3 V/m	$d = 1.2 \times \sqrt{P}$ 80 MHz to 800 MHz $d = 2.3 \times \sqrt{P}$ 800 MHz to 2.5 GHz
			where P is the maximum output power rating of the transmitter in watts (W) according to the transmitter manufacturer and d is the recommended separation distance in meters (m).
			Field strengths from fixed RF transmitters, as determined by an electromagnetic site survey, ^a should be less than the compliance level in each frequency range. ^b
			Interference may occur in the vicinity of equipment marked with the following symbol: 

NOTE: At 80 MHz and 800 MHz, the higher frequency range applies.

NOTE: These guidelines may not apply in all situations. Electromagnetic propagation is affected by absorption and reflection from structures, objects and people.

a Field strengths from fixed transmitters, such as base stations for radio (cellular/cordless) telephones and land mobile radios, amateur radio, AM and FM radio broadcast and TV broadcast cannot be predicted theoretically with accuracy. To assess the electromagnetic environment due to fixed RF transmitters, an electromagnetic site survey should be considered. If the measured field strength in the location in which the **V 12/V 21** is used exceeds the applicable RF compliance level above, the **V 12/V 21** should be observed to verify normal operation. If abnormal performance is observed, additional measures may be necessary, such as reorienting or relocating the **V 12/V 21**.

b Over the frequency range 150 kHz to 80 MHz, field strengths should be less than 3 V/m.

TABLE 28-32

RECOMMENDED SEPARATION DISTANCES BETWEEN PORTABLE AND MOBILE RF COMMUNICATIONS EQUIPMENT AND THE V 12/V 21

The V 12/V 21 is intended for use in an electromagnetic environment in which radiated RF disturbances are controlled. The customer or the user of the V 12/V 21 can help prevent electromagnetic interference by maintaining a minimum distance between portable and mobile RF communications equipment (transmitters) and the V 12/V 21 as recommended below, according to the maximum output power of the communications equipment.

RATED MAXIMUM OUTPUT POWER (P) OF TRANSMITTER IN WATTS (W)	SEPARATION DISTANCE (d) IN METERS (m) ACCORDING TO FREQUENCY OF TRANSMITTER		
	150 kHz to 80 MHz $d = 1.2 \times \sqrt{P}$	80 MHz to 800 MHz $d = 1.2 \times \sqrt{P}$	800 MHz to 2.5 GHz $d = 2.3 \times \sqrt{P}$
0.01	0.12	0.12	0.23
0.1	0.38	0.38	0.73
1	1.2	1.2	2.3
10	3.8	3.8	7.3
100	12	12	23

For transmitters rated at a maximum output power not listed above, the recommended separation distance d in meters (m) can be determined using the equation applicable to the frequency of the transmitter, where P is the maximum output power rating of the transmitter in watts (W) according to the transmitter manufacturer.

NOTE: At 80 MHz and 800 MHz, the separation distance for the higher frequency range applies.

NOTE: These guidelines may not apply in all situations. Electromagnetic propagation is affected by absorption and reflection from structures, objects and people.

28.15.3

FCC/IC

NOTE: This equipment has been tested and found to comply with the limits for a Class A digital device, pursuant to part 15 of the FCC rules. These limits are designed to provide reasonable protection against harmful interference when the equipment is operated in a commercial environment. This equipment generates, uses, and can radiate radio frequency energy and, if not installed and used in accordance with the instruction manual, may cause harmful interference to radio communications. Operation of this equipment in a residential area is likely to cause harmful interference in which case the user will be required to correct the interference at his own expense.

Under Industry Canada regulations, this radio transmitter may only operate using an antenna of a type and maximum (or lesser) gain approved for the transmitter by Industry Canada. To reduce potential radio interference to other users, the antenna type and its gain should be so chosen that the equivalent isotropically radiated power (e.i.r.p.) is not more than that necessary for successful communication.

Conformément à la réglementation d'Industrie Canada, le présent émetteur radio peut fonctionner avec une antenne d'un type et d'un gain maximal (ou inférieur) approuvé pour l'émetteur par Industrie Canada. Dans le but de réduire les risques de brouillage radioélectrique à l'intention des autres utilisateurs, il faut choisir le type d'antenne et son gain de sorte que la puissance isotrope rayonnée équivalente (p.i.r.e.) ne dépasse pas l'intensité nécessaire à l'établissement d'une communication satisfaisante.

28.16 Environmental Conditions

28.16.1 Power Supply

Power supplies from equipment used in tandem with the **V 12/V 21** will be specified by the manufacturer.

28.17 Sound

- Power-on self test tone
- Alarm tone
 - IEC alarm tone (high, medium, low; complies with the requirements of IEC60601-1-8)
 - Provides 1 to 10 levels of alarm tone adjustment.
 - Sound Pressure Range: 45 to 85 dB
- Key-pressing prompt tone
 - Provides hard key tones for informational signals
- Systole heartbeat tone/pulse beat tone (Pitch tone)
 - Provides 0 to 10 levels of tone adjustment. "0" stands for no sound.
 - Provides systole sound for technical signals
 - Provides Pitch Tone based on the SpO₂ value

28.18 Communication Protocols

Alarm Delay Time to Remote Equipment

The alarm delay time from the **V 12/V 21** to remote equipment is ≤ 2 seconds, measured at the **V 12/V 21** signal output connector.

28.19 Connection to Panorama[®] Central Station

The **V 12/V 21** communicates with the Panorama Central Station via direct hardwire CS1 port. The following parameters are supported on the Panorama Central Station from a **V 12/V 21** device: CO, CI, CO Time, SvO₂, CCO, CCI, SVR, SVRI, ScVO₂, CCO STAT, CCI STAT, and TBlood.

The **V 12/V 21** is capable of transmitting a discharge command to a Panorama Central Station. It is also capable of bi-directional transmission of patient demographics and patient alarm settings with a Panorama Central Station.

When **Discharge** is selected from the Patient Menu and Enable Network is set to "Wired", the Panorama discharges the patient.

28.20 Operator Position

The operator of the device should be positioned in front of the **V 12/V 21** display at a distance of no more than 1 meter.

Glossary

This section provides a glossary of terminology used throughout the **V 12/V 21** Operating Instructions.

- Terms, Acronyms, and Abbreviations

29.1 Terms, Acronyms, and Abbreviations

TERMS	DEFINITIONS
Agent	The gas used to anesthetize a patient during surgery
Arrhythmia	Abnormal ECG rhythms
Bedside Monitor	A monitoring device that has its own user interface and does not require the Panorama Central Station to be its primary monitoring source
Heart Rate	Number of heartbeats detected during a one minute time period
Internet Protocol (IP)	TCP/IP is the standard protocol that defines the IP datagram as the unit of information passed across an Internet. IP provides the basis for connectionless, best effort packet delivery of services.
Invasive Blood Pressure (IBP)	Method of obtaining blood pressure using an internal pressure sensor
Monitoring Device	The instrumentation connected to the patient. The monitoring device acquires the patient data and then transmits it onto the network.
Non-Invasive Blood Pressure (NIBP)	Method of obtaining blood pressure using an external cuff
Panorama Central Network	Supports hardwired communication between Panorama Central Stations and laser printers
Panorama Patient Network	Supports hardwired communication of the real-time patient data collected by monitoring devices attached to the patient
Panorama Wireless Network	Supports wireless communications between the wireless monitoring devices and the Panorama Server.
PAWP	Pulmonary Artery Wedge Pressure
Persistent	Data or settings maintained and remain available until purposely edited or deleted
Respiration	Number of breaths during a one minute time period
SpO₂	Level of Oxygen Saturation in the blood
ST	The ST portion of the ECG waveform

ACRONYMS/ABBREVIATIONS	DEFINITIONS
AA	Anesthetic Agent
ADT	Admit Discharge Transfer
AHA	American Heart Association American Hospital Association
APP	Abdominal Perfusion Pressure
ART	Arterial Pressure
APOD	Adaptive Probe Off Detection
AUC	Area Under Curve
awRR	Airway Respiratory Rate
AXI	Axillary
BLA	Bladder
bpm	Beats per minute
BL	Baseline
BSA	Body Surface Area
C	Current ST Chest Lead (IEC)
CCO	Continuous Cardiac Output
CCI	Continuous Cardiac Index
CePP	Cerebral Perfusion Pressure
cm	Centimeters
CO	Cardiac Output
CI	Cardiac Index
C-LAN	Panorama Central Network
CO₂	Carbon Dioxide
CVA	Cardiovascular Artifact
CVP	Central Venous Pressure
Des	Desoflurane
DO₂	Oxygen Delivery
dynes-sec/cm⁵/m²	Dynes per sec per centimeter to the power of 5 per meter squared
dynes-sec/cm⁵	Dynes per sec per centimeter to the power of 5
EDV	End Diastolic Volume
EDVI	End Diastolic Volume Index
ECG	Electrocardiogram
EMC	Electromagnetic Compatibility

ACRONYMS/ABBREVIATIONS	DEFINITIONS
Enf	Enflurane
EMR	Electronic Medical Records
ESO	Esophageal
ESV	End Systolic Volume
ESVI	End Systolic Volume Index
ET	End-Tidal when referencing CO ₂ /O ₂ /N ₂ O/Agent parameters Elapsed Time when referencing NIBP
F	Left Leg when referring to ECG Leads (IEC)
Hal	Haloflurane
HR	Heart Rate
IAP	Intra-abdominal Pressure
IBP	Invasive Blood Pressure
ICP	Intracranial Pressure
IEC	International Electro-Technical Commission
in	Inches
INSP	Inspired
IP	Internet Protocol
ISO	Isoflurane when referencing Agent Isoelectric when referencing ST monitoring
kg	Kilograms
kPa	Kilopascals Per Atmosphere
L	Left Arm when referring to ECG Leads (IEC)
l/min	Liters per minute
l/min/m²	Liters per minute per meter squared
LA	Left Arm when referring to ECG Leads (AHA)
lbs	Pounds
LL	Left Leg when referring to ECG Leads (AHA)
LV	Left Ventricle
MAC	Minimal Alveolar Concentration
MAP	Mean Arterial Pressure
MDD	Medical Device Directive
mmHg	Millimeters of Mercury
N	Right Leg when referring to ECG Leads (IEC)
N₂O	Nitrous Oxide
NAS	Nasal

ACRONYMS/ABBREVIATIONS	DEFINITIONS
NIBP	Non-Invasive Blood Pressure
NSR	Normal Sinus Rhythm
O₂	Oxygen
O2EI	Oxygen Extraction Index
PA	Pulmonary Artery
PI	Perfusion Index
Pleth	Plethysmograph
PVC	Premature Ventricular Contraction
R	Right Arm when referring to ECG Leads (IEC) Referenced ST
RA	Right Atrium when referring to IBP Right Arm when referring to ECG Leads (AHA)
REC	Rectal
RESP	Respiration Rate
RL	Right Leg when referring to ECG Leads (AHA)
rpm	Respirations per minute
rSO₂	Regional Oxygen Saturation
RVEF	Right Ventricular Ejection Fraction
ScVO₂	Central Venous Oxygen Saturation
Sev	Sevoflurane
SKI	Skin
SpO₂	Oxygen Saturation
SvO₂	Saturated Venous Oxygenation
SV	Stroke Volume
SVI	Stroke Volume Index
SVR	Systemic Vascular Resistance
SVRI	Systemic Vascular Resistance Index
SVV	Stroke Volume Variation
TEMP	Temperature
T Blood	Blood temperature
UA	Umbilical Artery
V	Chest Lead (AHA)
VDI	V Device Integrator
VO₂	Oxygen Consumption

This page intentionally left blank.

Addendum to Operating Instructions

VSeries
Patient Monitors

The Mindray logo is located in the bottom right corner of the page. It consists of the word "mindray" in a bold, lowercase, sans-serif font. The letters are a vibrant red color. The background of the entire page is a light gray gradient with a large, curved red band that sweeps across the lower half, and a faint sunburst graphic in the center.

Mindray® is a registered trademark of Shenzhen Mindray Bio-Medical Electronics Co., Ltd.

Edwards Vigileo™ is a U.S. trademark of Edwards Lifesciences LLC

Edwards Vigilance™ is a U.S. trademark of Edwards Lifesciences LLC

EV1000™ is a U.S. trademark of Edwards Lifesciences LLC

Somanetics® and INVOS® are registered trademarks of Covidien

Copyright © Mindray DS USA, Inc., 2013. All rights reserved. Contents of this publication may not be reproduced in any form without permission of Mindray DS USA, Inc.

Foreword	iii
About this Addendum	iii
Warnings.....	iii
Cautions	iii
Notes.....	iii
Indications for Use	iv
Continuous Cardiac Output (CCO) & Continuous Hemodynamics (Optional)	1 - 1
Introduction	1 - 2
CCO/Hemo Configuration.....	1 - 2
Navigating to the CCO Dialog.....	1 - 2
Configuring CCO/Hemo Alarms.....	1 - 4
Alarm Limits: CCO/Hemo Tab	1 - 4
Alarm Responses: CCO/Hemo Tab	1 - 6
Configuring the CCO Parameter	1 - 6
CCO Setup.....	1 - 8
Edwards Lifesciences Monitors	1 - 8
Connecting to an Edwards Monitor.....	1 - 8
Configuring the Edwards Monitor Serial Port	1 - 9
Digital Tiles	1 - 10
CCO Digital Tile Layout.....	1 - 10
About the CCO Tile	1 - 10
CCO Alarms	1 - 10
Message Area	1 - 11
CCO STAT Digital Tile Layout.....	1 - 12
About the CCO STAT Tile	1 - 12
CCO Alarms	1 - 12
Message Area	1 - 13
Hemo Digital Tile Layout	1 - 14
About the Hemo Tile	1 - 14
Hemo Tile Setup.....	1 - 15
Saving Hemo Calculations	1 - 16
Hemo Alarms.....	1 - 17
Message Area	1 - 17
CCO Troubleshooting	1 - 19
Gases (Optional).....	2 - 1
Introduction	2 - 2
Gas Dialog	2 - 3
Navigating to the Gas Dialog	2 - 3
Configuring Gases Alarm Limits.....	2 - 3
Configuring the Gases Parameter Setup.....	2 - 4
Calibrating Gases	2 - 6
Zeroing Manually.....	2 - 7
Restarting the monitoring.....	2 - 7
Gas Monitoring with Gas Module 3	2 - 8
Gases Tile Layouts	2 - 10
Gases Digital Tile Layout	2 - 10
About the Gases Digital Tile	2 - 10
Gases Alarms	2 - 10
Message Area	2 - 11
CO2 Waveform Tile Layout	2 - 11
Gases Troubleshooting	2 - 12

Regional Oxygen Saturation (rSO2)	
(Optional)	3 - 1
Introduction	3 - 2
rSO2 Configuration	3 - 2
Navigating to the rSO2 Dialog	3 - 2
Configuring rSO2 Alarms	3 - 3
Alarm Responses: rSO2 Tab	3 - 3
Configuring the rSO2 Parameter	3 - 3
rSO2 Setup	3 - 5
INVOS Monitor	3 - 5
Connecting to an INVOS Monitor	3 - 5
Configuring the INVOS Monitor Serial Port	3 - 6
rSO2 Tiles	3 - 7
rSO2 Digital Tile Layout	3 - 7
About the rSO2 Tile	3 - 8
rSO2 Alarms	3 - 8
Message Area	3 - 8
rSO2 Troubleshooting	3 - 9
Mixed Venous Oxygen Saturation (SvO2) (Optional)	4 - 1
Introduction	4 - 2
SvO2 Configuration	4 - 3
Navigating to the SvO2 Dialog	4 - 3
Configuring SvO2 Alarms	4 - 3
Alarm Limits: CCO/Hemo Tab	4 - 4
Alarm Responses: CCO/Hemo Tab	4 - 4
Configuring the SvO2 Parameter	4 - 4
SvO2 Setup	4 - 6
Edwards Lifesciences Monitors	4 - 6
Connecting to the Edwards Monitor	4 - 6
Configuring the Edwards Monitor Serial Port	4 - 7
SvO2 Digital Tile Layout	4 - 8
About the SvO2 Tile	4 - 8
SvO2 Alarms	4 - 8
Message Area	4 - 9
SvO2 Troubleshooting	4 - 9

Foreword

NOTE: **Figures in this manual are provided for reference purposes only. Screens may slightly differ based on screen resolution and setup configuration.**

General knowledge of monitoring and an understanding of the features and functions of the **V 12/V 21** are prerequisites for its proper use.

Please read and adhere to all of the warnings and precautions listed throughout this manual.

A **WARNING** is provided to alert the user to potentially serious outcomes (death, injury or serious adverse events) to the patient or the user.

A **CAUTION** is provided to alert the user that special care should be taken for the safe and effective use of the device. They will include actions to be taken to avoid effects on patients or users that will not be potentially life threatening or result in serious injury, but about which the user should be aware.

A **NOTE** is provided when additional general information is available.

About this Addendum

The purpose of this addendum is to describe the parameters which are available through the V Device Integrator (VDI) module. **Only use this addendum in tandem with the V Series Operating Instructions** . Each chapter contains the parameter alarm limits and alarm responses, instructions for connecting to the third party device (for example, Edwards Vigilance Monitor), digital tile layout, and troubleshooting.

Warnings

Refer to the Warnings in the V Series Operating Instructions for additional information.

Cautions

Refer to the Cautions in the V Series Operating Instructions for additional information.

Notes

Refer to the Notes in the V Series Operating Instructions for additional information.

Indications for Use

The V Series Monitoring System is intended for intra hospital use under the direct supervision of a licensed healthcare practitioner. The Indications for Use for the **V 12/V 21** include the monitoring of the following human physiological parameters:

- ECG waveform derived from 3, 5, 6 and 12 lead measurements
- Heart Rate
- Pulse Oximetry (SpO₂)
- ST Segment Analysis
- Arrhythmia Detection
- Non Invasive Blood Pressure (NIBP)
- Invasive Blood Pressure (IBP)
- Cardiac Output (CO)
- Respiratory Gases
- Respiration Rate
- Temperature

The **V 12/V 21** Monitor has the capability of performing IV Drug and Hemodynamic Calculations and interfacing with network devices.

The target populations are adult, pediatric and neonate with the exception of:

- Arrhythmia detection and ST Segment Analysis, for which the target populations are adult and pediatric only,
- IV Drug Calculations for which the target population is adult only, and
- Cardiac Output for which the target populations are adult and pediatric only.

Continuous Cardiac Output (CCO) & Continuous Hemodynamics (Optional)

Introduction	1-2
CCO/Hemo Configuration.....	1-2
CCO Setup.....	1-8
Digital Tiles.....	1-10
CCO Troubleshooting.....	1-19

1.1 Introduction

This chapter describes how to obtain Continuous Cardiac Output (CCO) and Continuous Hemodynamic values from the Edwards Vigilance, Vigilance II, Vigileo, and EV1000 monitors; and how to monitor and configure the alarm limits of the monitors. The Continuous Hemodynamic values are calculated from the CCO values.

Patient Sizes

Intended patient types: Adult and Pediatric.

VDI Module Connector

The VPS module does not include the CCO parameter. The CCO parameter is available through the serial port of a separate module called the V Device Integrator (VDI) (as shown in FIGURE 1-1).

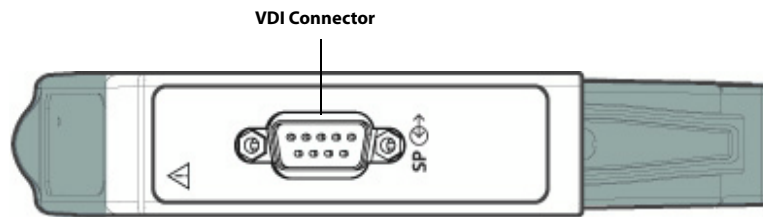

FIGURE 1-1 Example VDI Module Connector

Display Setup

To see the CCO and Hemo values, CCO and Hemo tiles must be configured to display on the Main Screen. Refer to "Display Options Dialog" on page 3-2 in the V Series Operating Instructions for additional information.

1.2 CCO/Hemo Configuration

The CCO dialog (as shown in FIGURE 1-2) contains an **Alarms** tab and a **Setup** tab.

The Hemo dialog (FIGURE 1-3) contains a **Parameters**, **Alarms** and **Setup** tab.

A description of each tab follows.

1.2.1 Navigating to the CCO Dialog

- Select the CCO or Hemo digital tile.

OR

1. Select the **Setup** tab from the Navigation Area.
2. Select the **Parameters** button.
3. Select the **CCO** button for the **CCO** dialog or select the **Hemo** button for the **Hemo** dialog.
The **CCO** or **Hemo** dialog is displayed (as shown in FIGURE 1-2 and FIGURE 1-3).

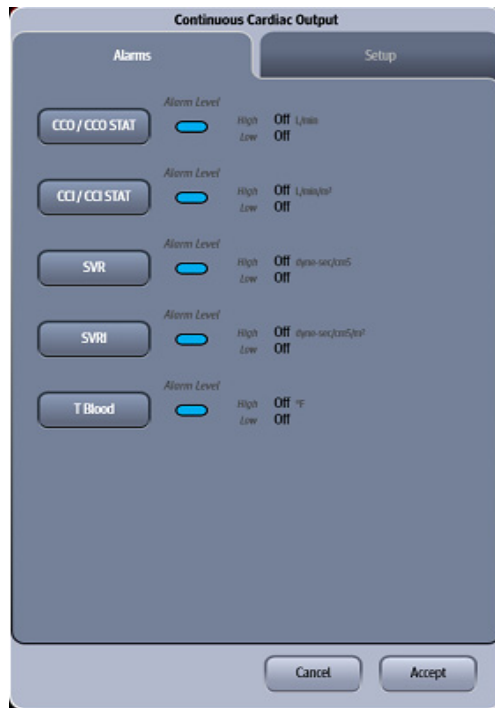

FIGURE 1-2 Example CCO Dialog (Alarms Tab)



FIGURE 1-3 Example Hemo Dialog (Alarms Tab)

1.2.2 Configuring CCO/Hemo Alarms

For a full explanation about alarm responses and instructions for accessing and using these alarm dialogs, refer to the Alarms chapter in the V Series Operating Instructions.

1.2.2.1 Alarm Limits: CCO/Hemo Tab

TABLE 1-1 lists the alarm limit ranges for the CCO parameter, which is contained in the **CCO** tab and **Hemo** tab.

TABLE 1-1

PARAMETER	ALARM LIMIT	ADULT	PEDIATRIC	NEONATE
CCO/CCO STAT Unit of Measure: L/min Resolution: 0.1 L/min Invalid data: "--"	High Limit	Off , 2.0 to 20.0	Off , 2.0 to 20.0	N/A
	Low Limit	Off , 1.0 to 19.0	Off , 1.0 to 19.0	N/A
CCI/CCI STAT Unit of Measure: L/min/m ² Resolution: 0.1 L/min/m ² Invalid data: "--"	High Limit	Off , 2.0 to 20.0	Off , 2.0 to 20.0	N/A
	Low Limit	Off , 1.0 to 19.0	Off , 1.0 to 19.0	N/A
SVR Unit of Measure: dyne-sec/cm ⁵ Resolution: 1 dyne-sec/cm ⁵ Invalid data: "--"	High Limit	Off , 500 to 5000	Off , 500 to 5000	N/A
	Low Limit	Off , 0 to 2000	Off , 0 to 2000	N/A
SVRI Unit of Measure: dyne-sec/cm ⁵ /m ² Resolution: 1 dyne-sec/cm ⁵ /m ² Invalid data: "--"	High Limit	Off , 1000 to 9950	Off , 1000 to 9950	N/A
	Low Limit	Off , 0 to 4000	Off , 0 to 4000	N/A
T Blood Unit of Measure: °F Resolution: 0.1 °F Invalid data: "--"	High Limit	Off , 95.0 to 110.0	Off , 95.0 to 110.0	N/A
	Low Limit	Off , 80.0 to 100.0	Off , 80.0 to 100.0	N/A
T Blood Unit of Measure: °C Resolution: 0.1°C Invalid data: "--"	High Limit	Off , 35.0 to 43.0	Off , 35.0 to 43.0	N/A
	Low Limit	Off , 26.0 to 38.0	Off , 26.0 to 38.0	N/A

* The factory default configuration settings are in bold.

TABLE 1-1

PARAMETER	ALARM LIMIT	ADULT	PEDIATRIC	NEONATE
SV/SV STAT Unit of Measure: ml/beat Resolution: 1 ml/beat Invalid data: "--"	High Limit	Off , 20 to 300	Off , 20 to 300	N/A
	Low Limit	Off , 0 to 140	Off , 0 to 140	N/A
SVI/SVI STAT Unit of Measure: ml/beat/m ² Resolution: 0.1 ml/beat/m ² Invalid data: "--"	High Limit	Off , 20.0 to 200.0	Off , 20.0 to 200.0	N/A
	Low Limit	Off , 0.0 to 100.0	Off , 0.0 to 100.0	N/A
EDV/EDV STAT Unit of Measure: ml Resolution: 1 ml Invalid data: "--"	High Limit	Off , 40 to 800	Off , 40 to 800	N/A
	Low Limit	Off , 0 to 400	Off , 0 to 400	N/A
EDVI/EDVI STAT Unit of Measure: ml/m ² Resolution: 0.1 ml/m ² Invalid data: "--"	High Limit	Off , 20.0 to 400.0	Off , 20.0 to 400.0	N/A
	Low Limit	Off , 0.0 to 200.0	Off , 0.0 to 200.0	N/A
RVEF/RVEF STAT Unit of Measure: % Resolution: 1% Invalid data: "--"	High Limit	Off , 20 to 100	Off , 20 to 100	N/A
	Low Limit	Off , 0 to 60	Off , 0 to 60	N/A

* The factory default configuration settings are in bold.

1.2.3 Alarm Responses: CCO/Hemo Tab

To display the alarm responses for the **CCO/Hemo** tab:

1. Select the **Alarms** tab from the Navigation Area.
2. Select the **Responses** button.
3. Select the **CCO/Hemo** tab.

TABLE 1-2 contains the alarm responses for the CCO/Hemo parameter.

TABLE 1-2

ALARM LEVELS BUTTON	ALARM LEVELS*			FACTORY DEFAULT ALARM RESPONSES		
	HIGH	MEDIUM	LOW	PRINT ON ALARM	SAVE TO EVENT	NURSE CALL
CCO/CCI	X	X	X	Off	On	Off
SVR/SVRI	X	X	X	Off	On	Off
RVEF/EDV/EDVI/SV/SVI	—	X	X	Off	On	Off
SvO2	X	X	X	Off	On	Off

* X indicates available alarm level, — indicates alarm level not available

** The factory default configuration settings are in bold.

1.2.4 Configuring the CCO Parameter

1. Select the **Setup** tab from the Navigation Area.
2. Select the **Parameters** button, then select the **CCO** button.
or
Select the **CCO** digital tile.
3. Select the **Setup** tab (as shown in FIGURE 1-4).

NOTE: The current parameter setting displays in bold to the right of each button.



FIGURE 1-4 Example CCO Dialog (Setup Tab)

4. Select the buttons described in TABLE 1-3 to configure the tab.

TABLE 1-3

BUTTON	DESCRIPTION / COMMENTS	CHOICES*
Display SVR	Configures whether SVR or SVRI is shown or not shown in the CCO tile.	None , SVR, SVRI
Color	Configures the CCO, CCI, SVR, SVRI, CCO STAT and CCI STAT parameter color.	There are 16 different colors available. The factory default is yellow .
Check Vigilance Tone	When configured for On, a technical tone sounds when the technical message "Check Vigilance" displays in the message area.	On , Off

* *The factory default configuration settings are in bold.*

5. Select the **Cancel** or **Accept** button.
- The **Cancel** button closes the dialog without saving the settings.
 - The **Accept** button saves the settings and closes the dialog.

1.3 CCO Setup

1.3.1 Edwards Lifesciences Monitors

For questions regarding the use and maintenance of the Edwards Vigilance[®], Vigilance II, the Vigileo[™], and the EV1000[™] monitors, refer to its operator's manual or contact Edwards Lifesciences Corporation for assistance. Within the USA: (800)-424-3278, Outside the USA: (949)-250-2500.

The standard Edwards monitor measures both intermittent and continuous cardiac output (CCO), and T Blood. It can also be optionally configured to measure continuous mixed venous oxygen saturation (SvO₂). Intermittent CO uses the bolus thermodilution method, while continuous CO uses a pulmonary artery catheter to introduce small pulses of energy into the blood and then record the blood temperature. SvO₂ is measured by a spectrophotometric technique that uses light emitting diodes to transmit light in the red and infrared spectra through an optical fiber in a pulmonary artery catheter to the blood.

The **V 12/V 21** can interface with the Edwards Vigilance[®], Vigilance II, the Vigileo[™] and the EV1000[™]. This enables CO, T Blood and SvO₂ data to be displayed and trended at the **V 12/V 21**, while providing alarm control for these parameters. The **V 12/V 21** uses T Blood data from Edwards monitor to derive ΔT which can also be displayed and trended, as well as providing alarm control.

At the **V 12/V 21**, the CO value is divided by the patient's BSA (Body Surface Area) to calculate and display a corresponding cardiac index (CI). The BSA is determined from the patient's height and weight as entered in the **V 12/V 21**.

1.3.2 Connecting to an Edwards Monitor

The following are needed to connect the **V 12/V 21** to an Edwards monitor:

- Vigilance[®], Vigilance II, Vigileo[™], or EV1000[™]
- One serial cable

NOTE: Use the serial cable supplied with the Edwards monitor to interface with the VDI module.

- One VDI module
- One 1x slot in the V Hub or Integrated V Hub

NOTE: Refer to "Module Status Dialog" on page 5-2 in the V Series Operating Instructions for additional information about 1x modules.

1. Connect the serial cable to an available COM port (as shown in FIGURE 1-5) on the back side of an Edwards monitor.

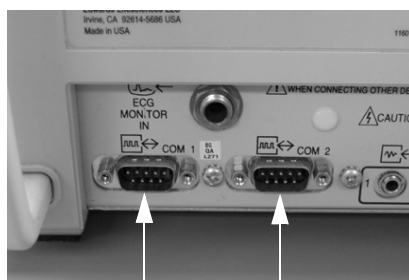

FIGURE 1-5 Example COM Port (Vigilance monitor shown in this example)

2. Insert the VDI module into the V Hub or Integrated V Hub.

3. Connect the other end of the serial cable to serial port on the VDI module.
4. Verify the current VDI mode is configured to Vigilance.

NOTE: Refer to "Changing VDI Modes" on page 5-4 of the V Series Operating Instructions for additional information.

5. Turn on the Edwards monitor.

1.3.3 Configuring the Edwards Monitor Serial Port

Before configuring the **V 12/V 21** monitor to display SvO₂, the Edwards monitor serial port must be properly configured to communicate bidirectionally with the **V 12/V 21**. Using the operating instructions from the Edwards monitor, verify the following:

Baud Rate	19200
Parity	None
Stop Bits	1
Data Bits	8
Flow Control	2 Seconds

1.4 Digital Tiles

1.4.1 CCO Digital Tile Layout

The CCO digital tile displays:

1. CCO value
2. Message area
3. CCI value
4. CCI alarm limits
5. T Blood alarm limits
6. Units of measure
7. T Blood value
8. SVR or SVRI value
9. SVR or SVRI alarm limits
10. CCO alarm limits

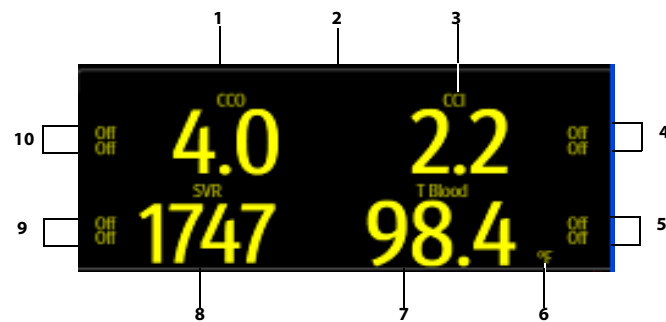

FIGURE 1-6 Example CCO Digital Tile (with SVR enabled)

1.4.2 About the CCO Tile

- The CCO tile displays all CCO in units of l/min with a resolution of 0.1 l/min.
- If the CCO measurement is invalid, "--" displays in place of digits.

1.4.3 CCO Alarms

Refer to the "Configuring CCO/Hemo Alarms" on page 1-4 for additional information.

1.4.4 Message Area

The message area provides information about the current state of the CCO parameter. If there is more than one message to display, the messages scroll.

MESSAGE	DETAILS
CCO High Alarm Violation	Indicates that the current value is either equal to or higher than the set alarm limits.
CCO Low Alarm Violation	Indicates that the current value is either equal to or lower than the set alarm limits.
CCI High Alarm Violation	Indicates that the current value is either equal to or higher than the set alarm limits.
CCI Low Alarm Violation	Indicates that the current value is either equal to or lower than the set alarm limits.
T Blood High Alarm Violation	Indicates that the current value is either equal to or higher than the set alarm limits.
T Blood Low Alarm Violation	Indicates that the current value is either equal to or lower than the set alarm limits.
SVR High Alarm Violation	Indicates that the current value is either equal to or higher than the set alarm limits.
SVR Low Alarm Violation	Indicates that the current value is either equal to or lower than the set alarm limits.
SVRI High Alarm Violation	Indicates that the current value is either equal to or higher than the set alarm limits.
SVRI Low Alarm Violation	Indicates that the current value is either equal to or lower than the set alarm limits.
Check Vigilance	Indicates there is an error on the Edwards device that is not a physiological alarm. It is a prompt for the clinician to look at the Edwards device for more detailed information.

1.4.5 CCO STAT Digital Tile Layout

The CCO STAT digital tile displays:

1. CCO STAT value
2. Message area
3. CCI STAT value
4. CCI STAT alarm limits
5. T Blood alarm limits
6. Units of measure
7. T Blood value
8. SVR or SVRI value
9. SVR or SVRI alarm limits
10. CCO STAT alarm limits

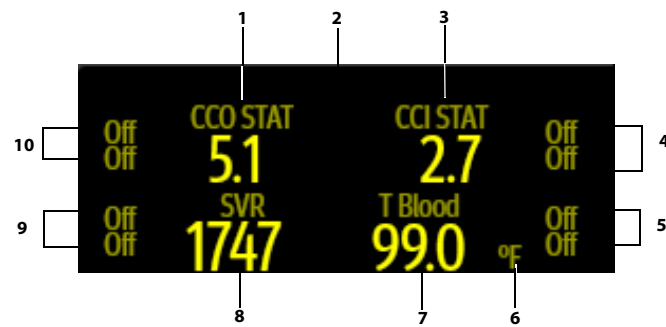

FIGURE 1-7 Example CCO STAT Digital Tile (with SVR enabled)

1.4.6 About the CCO STAT Tile

- The CCO STAT tile displays all CCO STAT in units of l/min with a resolution of 0.1 l/min.
- If the CCO STAT measurement is invalid, "--" displays in place of digits.

1.4.7 CCO Alarms

Refer to the "Configuring CCO/Hemo Alarms" on page 1-4 for additional information.

1.4.8 Message Area

The message area provides information about the current state of the CCO STAT parameter. If there is more than one message to display, the messages scroll.

MESSAGE	DETAILS
CCO STAT High Alarm Violation	Indicates that the current value is either equal to or higher than the set alarm limits.
CCO STAT Low Alarm Violation	Indicates that the current value is either equal to or lower than the set alarm limits.
CCI STAT High Alarm Violation	Indicates that the current value is either equal to or higher than the set alarm limits.
CCI STAT Low Alarm Violation	Indicates that the current value is either equal to or lower than the set alarm limits.
T Blood High Alarm Violation	Indicates that the current value is either equal to or higher than the set alarm limits.
T Blood Low Alarm Violation	Indicates that the current value is either equal to or lower than the set alarm limits.
SVR High Alarm Violation	Indicates that the current value is either equal to or higher than the set alarm limits.
SVR Low Alarm Violation	Indicates that the current value is either equal to or lower than the set alarm limits.
SVRI High Alarm Violation	Indicates that the current value is either equal to or higher than the set alarm limits.
SVRI Low Alarm Violation	Indicates that the current value is either equal to or lower than the set alarm limits.

1.4.9 Hemo Digital Tile Layout

The Hemo digital tile displays:

1. Tile name
2. Message area
3. Parameters (display up to six (6) of the following parameters):

- RVEF
- RVEF STAT
- SV
- SVI
- SV STAT
- SVI STAT
- SVV
- EDV
- EDVI
- EDV STAT
- EDVI STAT
- ESV
- ESVI
- ScVO2

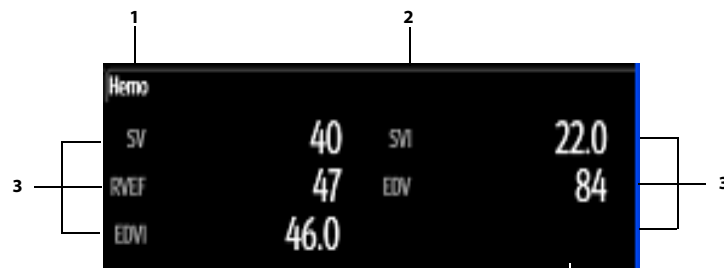

FIGURE 1-8 Example Hemo Digital Tile (Two column format)

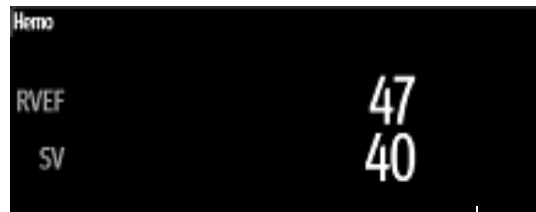

FIGURE 1-9 Example Hemo Digital Tile (One column format)

1.4.10 About the Hemo Tile

- The Hemo tile does not display units of measure.
- The Hemo tile can display up to six (6) parameters in a two column format.
- The Hemo tile can display up to three (3) parameters in the one column format.

1.4.11 Hemo Tile Setup

To configure the parameters that display in the Hemo tile:

1. Select the Hemo tile.
2. Select the **Setup** tab.
3. Select the **Hemo Tile Setup** button.
The Hemo Tile Setup dialog displays (as shown in FIGURE 1-10).





FIGURE 1-10

4. Navigate in this dialog by using the buttons described in TABLE 1-4.

TABLE 1-4

BUTTON	DESCRIPTION
Add	Adds the highlighted parameter(s) to the Selected list (located on the right side of the dialog).
	NOTE: A maximum of six (6) parameters may be highlighted in the list before selecting the button.
Remove	Removes the highlighted parameter(s) from the Selected list and moves them to the Choices list.
Remove All	Removes all the selected parameters from the Selected list and moves them to the Choices list.
Move to Top	Moves the selected parameter to the top position in the Selected list.
Move Up	Moves the selected parameter up one position in the Selected list.
Move Down	Moves a parameter from the Selected list down one position.

TABLE 1-4

BUTTON	DESCRIPTION
Move to Bottom	Moves the selected parameter to the bottom position in the Selected list.
	Scrolls up the Choices or Selected lists.
	Scrolls down the Choices or Selected lists.

5. Select the **Cancel** or **Accept** button to close the Hemo Tile Setup dialog.
 - The **Cancel** button closes the dialog without saving the settings.
 - The **Accept** button saves the settings and closes the dialog.
6. Select the **Cancel** or **Accept** button to close the Hemo dialog.
 - The **Cancel** button closes the dialog without saving the settings.
 - The **Accept** button saves the settings and closes the dialog.

1.4.12 Saving Hemo Calculations

To save the hemodynamic parameter calculations to the Hemodynamics Log:

To configure the parameters that display in the Hemo tile:

1. Select the Hemo tile.
2. Verify that there are calculations in the Hemodynamics Parameters table (as shown in FIGURE 1-11).

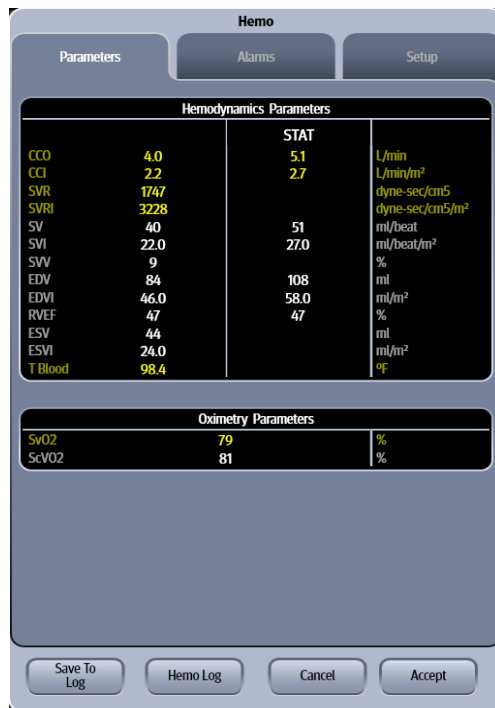

FIGURE 1-11

3. Select the **Save to Log** button.
4. Optional - select the **Hemo Log** button to access the Hemodynamics Calculator.
5. Select **Accept** or **Cancel**.

NOTE: Refer to "**Hemodynamics Calculations**" on page 21-2 in the **V Series Operation Instructions** for additional information.

1.4.13 Hemo Alarms

Refer to the "Configuring CCO/Hemo Alarms" on page 1-4 for additional information.

1.4.14 Message Area

The message area provides information about the current state of the Hemo parameter. If there is more than one message to display, the messages scroll.

MESSAGE	DETAILS
RVEF High Alarm Violation	Indicates that the current value is either equal to or higher than the set alarm limits.
RVEF Low Alarm Violation	Indicates that the current value is either equal to or lower than the set alarm limits.
RVEF STAT High Alarm Violation	Indicates that the current value is either equal to or higher than the set alarm limits.
RVEF STAT Low Alarm Violation	Indicates that the current value is either equal to or lower than the set alarm limits.
EDV High Alarm Violation	Indicates that the current value is either equal to or higher than the set alarm limits.
EDV Low Alarm Violation	Indicates that the current value is either equal to or lower than the set alarm limits.
EDV STAT High Alarm Violation	Indicates that the current value is either equal to or higher than the set alarm limits.
EDV STAT Low Alarm Violation	Indicates that the current value is either equal to or lower than the set alarm limits.
EDVI High Alarm Violation	Indicates that the current value is either equal to or higher than the set alarm limits.
EDVI Low Alarm Violation	Indicates that the current value is either equal to or lower than the set alarm limits.
EDVI High Alarm Violation	Indicates that the current value is either equal to or higher than the set alarm limits.
EDVI Low Alarm Violation	Indicates that the current value is either equal to or lower than the set alarm limits.
SV High Alarm Violation	Indicates that the current value is either equal to or higher than the set alarm limits.
SV Low Alarm Violation	Indicates that the current value is either equal to or lower than the set alarm limits.
SV STAT High Alarm Violation	Indicates that the current value is either equal to or higher than the set alarm limits.
SV STAT Low Alarm Violation	Indicates that the current value is either equal to or lower than the set alarm limits.
SVI High Alarm Violation	Indicates that the current value is either equal to or higher than the set alarm limits.
SVI Low Alarm Violation	Indicates that the current value is either equal to or lower than the set alarm limits.

MESSAGE	DETAILS
SVI STAT High Alarm Violation	Indicates that the current value is either equal to or higher than the set alarm limits.
SVI STAT Low Alarm Violation	Indicates that the current value is either equal to or lower than the set alarm limits.

1.5 CCO Troubleshooting

The CCO tile message area displays messages indicating the current state of the CCO parameter. If there is more than one message to display, the messages scroll.

MESSAGE/PROBLEM	REASON	SOLUTION
Dashes "--" display in place of numerics.	Measurement is invalid.	Check catheter placement.
	VDI mode may be incorrect.	Change VDI mode to Vigilance.
Check Vigilance	Indicates there is an error on the Edwards device that is not a physiological alarm.	Look at the Edwards device for more detailed information.

This page intentionally left blank.

Gases (Optional)

Introduction	2-2
Gas Dialog	2-3
Gas Monitoring with Gas Module 3	2-8
Gases Tile Layouts.....	2-10
Gases Troubleshooting	2-12

2.1 Introduction

The **V 12/V 21** works with Mindray DS **Gas Module 3** to measure and monitor inspired and expired O₂, CO₂, N₂O and five (5) anesthetic agents--Isoflurane (ISO), Sevoflurane (Sev), Desflurane (Des), Halothane (Hal), and Enflurane (Enf).

Mindray DS Gas Module 3 is a leading-edge breath-by-breath gas analyzer, which delivers state-of-the-art gas monitoring and analysis capabilities. Refer to **Gas Module 3 Operating Instructions (P/N 0070-10-0696-02)** for additional information regarding the use and maintenance of the device.

This chapter describes the Gas module in detail, including how to configure Gas alarm limits, configure the Gas parameter, calibrate and monitor gases.

The **V 12/V 21** gases monitoring provides:

- awRR: Airway Respiratory Rate
- MAC: Minimal Alveolar Concentration
- inspired and expired values for CO₂, O₂, N₂O and AA.
- CO₂ waveform

NOTE: **AA represents one of five (5) anesthetic agents--Hal, ISO, Enf, Sev, and Des.**

NOTE: **This module does not display O₂ monitoring for AION 2.5G AG module.**

Patient Sizes

Intended patient types: Adult, Pediatric, Neonate.

VDI Module Connector

The VPS module does not include the Gases parameter. The Gases parameter is available through the serial port of a separate module called the V Device Integrator (VDI) (as shown in FIGURE 2-1).

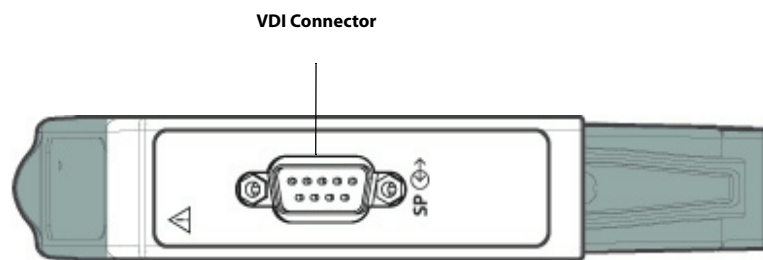

FIGURE 2-1 Example VDI Module Connector

Display Setup

To see the Gas values, Gases must be configured to display on the Main Screen. Refer to "Display Options Dialog" on page 3-2 in the V Series Operating Instructions for additional information.

2.2 Gas Dialog

The **Gas** dialog (as shown in FIGURE 2-2) contains an **Alarm** tab, **Setup** tab, and a **Calibrate** tab. A description of each tab follows.

2.2.1 Navigating to the Gas Dialog

- Select the Gases digital tile.

OR

1. Select the **Setup** tab from the Navigation Area.
2. Select the **Parameters** button.
3. Select the **Gases** button.
The **Gases** dialog displays (as shown in FIGURE 2-2).

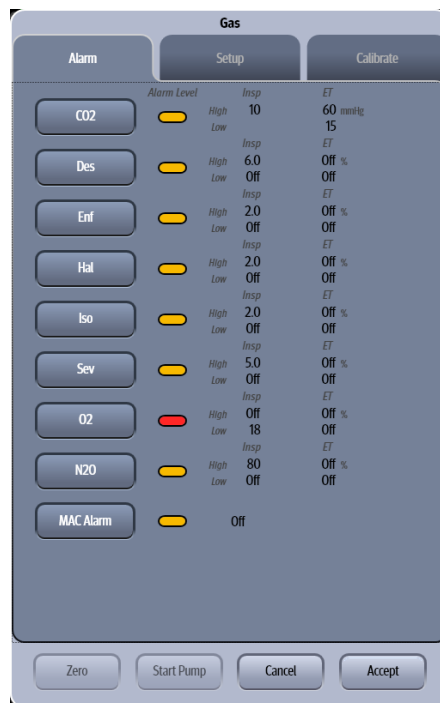

FIGURE 2-2 Example Gas Dialog (Alarm tab)

2.2.2 Configuring Gases Alarm Limits

1. Select the Gases digital tile.
2. Select the **Alarm** tab.

NOTE: The current parameter setting displays in bold to the right of each button.

When the CO₂, Des, Enf, Hal, Isp, Sev, O₂, or N₂O button is selected, the corresponding alarm dialog is displayed. FIGURE 2-3 displays the CO₂ Alarm dialog.

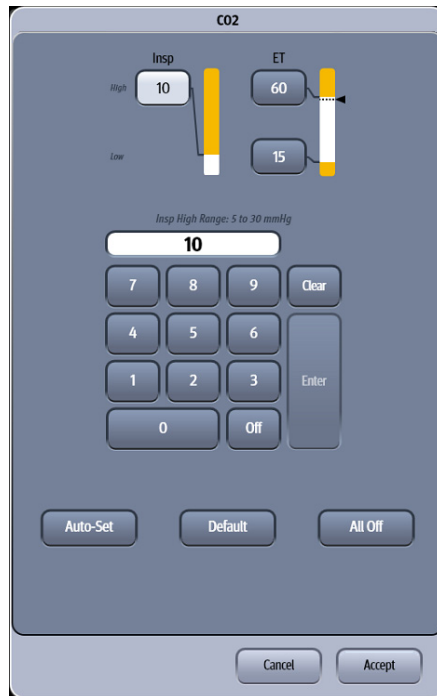

FIGURE 2-3 Example CO₂ Alarm Dialog

NOTE: For the limit ranges of N₂O, O₂, and five known anesthetic agents, refer to "Configuring Alarm Limits" on page 8-2 in the V Series Operating Instructions.

2.2.3 Configuring the Gases Parameter Setup

1. Select the Gases digital tile.
2. Select the **Setup** tab (as shown in FIGURE 2-4).

NOTE: The current parameter setting displays in bold to the right of each button.

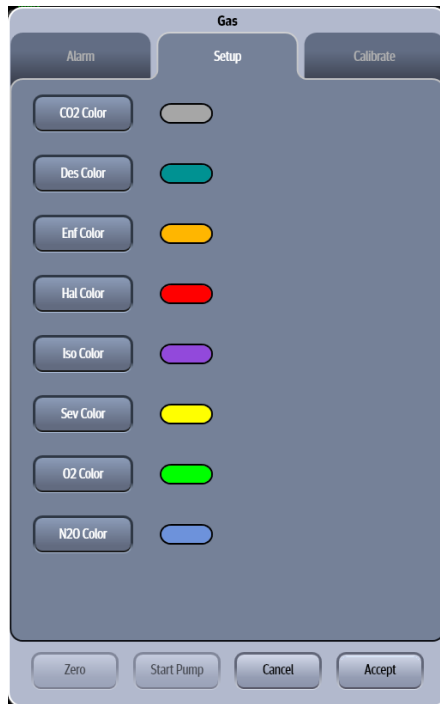

FIGURE 2-4 Example Gas Dialog (Setup Tab)

3. Select the buttons described in TABLE 2-1 to configure the tab.

TABLE 2-1

FUNCTION	DESCRIPTION	CHOICES*
CO2 Color	Configures the CO ₂ parameter color.	There are 16 distinct colors available. Default color is gray .
Des Color	Configures the Des parameter color.	There are 15 distinct colors available. Default color is blue .
Enf Color	Configures the Enf parameter color.	There are 15 distinct colors available. Default color is orange .
Hal Color	Configures the Hal parameter color.	There are 15 distinct colors available. Default color is red .
Iso Color	Configures the Iso parameter color.	There are 15 distinct colors available. Default color is violet .
Sev Color	Configures the Sev parameter color.	There are 15 distinct colors available. Default color is yellow .
O2 Color	Configures the O ₂ parameter color.	There are 15 distinct colors available. Default color is green .
N2O Color	Configures the N ₂ O parameter color.	There are 15 distinct colors available. Default color is blue violet .

* *The factory default configuration settings are in bold.*

4. Select the **Cancel** or **Accept** button.
 - The **Cancel** button closes the dialog without saving the settings.
 - The **Accept** button saves the settings and closes the dialog.

2.2.4 Calibrating Gases

Calibration is required when it has been more than one (1) year from the time of the last successful calibration or whenever the readings appear to be in error. The date of the last successful calibration displays in the Gases Calibration dialog.

NOTE: For maximum accuracy during calibration, a 10 minute warm-up time is recommended.

1. Select the Gases digital tile.
2. Select the **Calibrate** tab (as shown in FIGURE 2-5).



FIGURE 2-5 Example Gas Dialog (Calibrate Tab)

TABLE 2-2

FUNCTION	DESCRIPTION	SETTINGS*
Gas Selection	Selects calibration gas type.	Mixture , 5% CO ₂ , 55% O ₂ , 33% N ₂ O, 2%Des
Start	Starts the gases calibration	/

* *The factory default configuration settings are in bold.*

3. Select the **Gas Selection** button, and then select the calibration gas type.
4. Select the **Start** button to begin calibrating. At the start of the calibration, the message **"Zeroing..."** initially displays for each of the gas labels when the Gas Module zeros the gas channels. After successful zeroing, the Gas Module requests the calibration gas. The message **"Feed Calibration Gas"** displays.

NOTE: If the Gas Module cannot zero, sample, or calibrate, a message “Zeroing Error”, “Sampling Error” or “Calibrating Error” displays and the previous calibration data is restored. Repeat the calibration procedure from step 3. If problems persist, contact Mindray for technical support.

5. Attach the calibration gas canister to the regulator and turn it on. Increasing gas values appear in the window when the Gas Module samples the calibration gas. When calibration is complete, the message “Choose Accept” displays and the message “Complete” displays beside each measured value.
6. Select the **Abort** or **Accept** button.
 - The **Accept** button accepts the calibration values.
After a successful calibration, the message “Disconnect Calibration Gas” displays, followed by the message “Calibration Successful”.
Following an unsuccessful calibration, the message “Disconnect Calibration Gas” displays, and the message “Calibration Error” displays beside each measured value.
 - The **Abort** button cancels the calibration and restores the previous calibration values.

NOTE: To avoid premature emptying of the gas canister, always remove the regulator at the end of the procedure.

2.2.5 Zeroing Manually

Select the **Zero** button at the bottom of Gases dialog to manually zero the gases.

2.2.6 Restarting the monitoring

When the Gas Module 3 detects a prolonged issue, such as occlusion, then it may turn off the pump to protect the device and stop monitoring. Select the **Start Pump** button to restart the monitoring.

2.3 Gas Monitoring with Gas Module 3

WARNING: When using the Gas Module 3, the maximum sampling rate at the nasal cannula is 200 ml/min with an Adult/Pediatric water trap and 120 ml/min with a Neonatal water trap. This device should not be used on patients whose breathing could be impaired by this vacuum flow rate.

NOTE: The Gas Module 3 is equipped with automatic barometric pressure compensation.

NOTE: The Gas Module 3 uses a fixed correction of 11 hPa to compensate for the influence of water vapor in the gas sample, when converting the gas readings to ATPD. An increase in the ambient H₂O partial pressure to 30 hPa (i.e. 28 °C, 80% RH or 33 °C, and 60% RH) will cause a general error for all gases of only -2% REL.

NOTE: To prevent moisture from entering the pneumatic system, ensure that the Gas Module 3 is always installed and operated in the horizontal orientation shown in all graphical depictions.

1. Ensure that the VDI module connected with the Gas Module 3 is connected to the **V 12/V 21**.
2. Turn on the Gas Module 3 and the **V 12/V 21**.
3. Select **Gas** as the VDI mode in the **Integrated V Hub** or **V Hub x** (x represents the V Hub number) from the menu in the **Module Status** dialog. Refer to "Changing VDI Modes" on page 5-4 in the V Series Operating Instructions for additional information.
4. Configure Gases and CO₂ to display on the Main Screen. Refer to "Display Options Dialog" on page 3-2 in the V Series Operating Instructions for additional information.
5. Set alarms as desired. Refer to "Configuring Gases Alarm Limits" on page 2-3 for additional information.
6. For non-intubated patients, apply the nasal cannula to the patient. For intubated patients connect the sample line to the breathing circuit. Refer to instructions provided in the sample line packets.
7. Connect the other end of the nasal cannula or sample line to the Gas Module 3 at the input port. Ensure all tubing connections are tight.

WARNING: Connection of the Gas Module 3 exhaust port to the hospital's waste gas scavenging system is strongly recommended to prevent exposure of hospital personnel to the patient's respiratory sample. Vacuum (negative pressure) should not exceed 1 mmHg at the Gas Module Pump Exhaust fitting. Excessive scavenge vacuum may result in damage to the Gas Module's internal pump.

CAUTION: Contamination with CO₂, N₂O or Anesthetic Agent in the air surrounding the Gas Module 3 may cause significant measurement errors.

8. Check for a clean water trap.

NOTE: The Gas Module 3 must be warmed up a minimum of 45 seconds for ISO accurate CO₂, O₂, N₂O, and agent readings.

NOTE: Refer to Gas Module 3 Operating Instructions (P/N 0070-10-0696-02) for more details about Gas Module 3 operating instructions.

On the Main Screen of the **V 12/V 21**, the measurement values for anesthetic gases, N₂O, O₂, and CO₂ display in their digital tile, as shown in FIGURE 2-6.

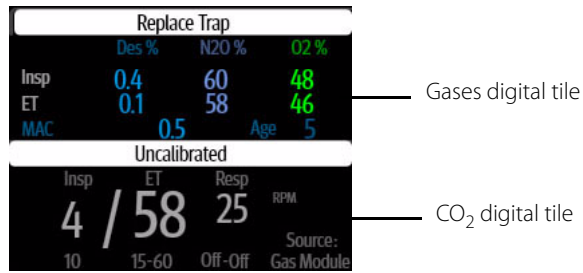

FIGURE 2-6 Example of measurement values for gases, N₂O, O₂, and CO₂

2.4 Gases Tile Layouts

The Gases parameter is shown in a digital tile.

2.4.1 Gases Digital Tile Layout

The Gases digital tile displays:

1. Message area
2. Unit of measure
3. Insp Gases value
4. ET Gases value
5. Patient Age
6. MAC Value

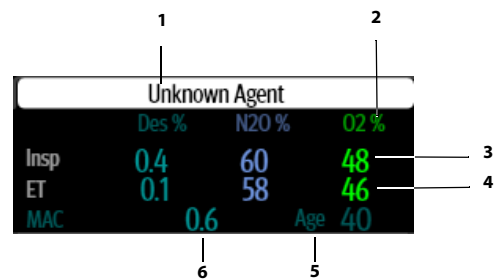

FIGURE 2-7 Example Gases Digital Tile

2.4.2 About the Gases Digital Tile

- If a gas measurement is invalid, "--" displays in place of digits.
- The Gases tile displays all values in units of percent (%).
The agent displays values with a resolution of 0.1%,
The N₂O and O₂ display values with a resolution of 1%.
- When the system detects a gas that is not one of the five known anesthetic agents, the gas label displays as "AA".
- The color of MAC label and value, and the color of Age are same as the color of the primary agent.

2.4.3 Gases Alarms

Refer to the "Gases Tab" on page 8-8 in the V Series Operating Instructions for additional information.

2.4.4 Message Area

The message area provides information about the current state of the gases parameter. If there is more than one message to display, the messages scroll.

MESSAGE	DETAILS
ET XX High Alarm Violation *	Indicates that the current value is either equal to or higher than the set alarm limits.
ET XX Low Alarm Violation*	Indicates that the current value is either equal to or lower than the set alarm limits.
Insp XX High Alarm Violation *	Indicates that the current value is either equal to or higher than the set alarm limits.
Insp XX Low Alarm Violation*	Indicates that the current value is either equal to or lower than the set alarm limits.
MAC < 3	During episodes of mixed agent when MAC value is less than 3.
MAC > 3	<ul style="list-style-type: none"> • During episodes of mixed agent when MAC value is equal or greater than 3. • When MAC Alarm in Gas alarm limit has been configured to be On and a single agent is present.
Mixed Agent	During episodes of mixed agent if the MAC value is invalid.
Unknown Agent	Indicates that the detected gas is not one of five known anesthetic agents—Iso, Hal, Enf, Sev or Des.
Gas Calibrating	Indicates that the Gas Module calibration is active.
Zeroing	Indicates that the Gas Module is currently zeroing.
Pump Off	Indicates that the pump is off.
Occlusion	Indicates that the filterline is blocked.
Calibration Failed	Indicates that the most recent Gas Module calibration failed.
Warming Up	Indicates that the Gas Module has not yet reached its operating temperature.
Unable to Zero	Indicates a failure on zeroing any of the gas parameters.
Exhaust Blocked	Indicates that the exhaust is blocked.
Replace Trap	Indicates that the trap needs to be replaced.
Gas Module Failure	Indicates a general Gas Module failure.
Gas Module Disconnected	Indicates that the Gas Module 3 is disconnected.

* *XX indicates O₂, N₂O or AA gases.*

2.4.5 CO₂ Waveform Tile Layout

Refer to "CO₂ Waveform Tile Layout" on page 17-11 in the V Series Operating Instructions for additional information about CO₂ waveform tile layout.

2.5 Gases Troubleshooting

The Gases tile message area displays messages indicating the current state of the Gases parameter. If there is more than one message to display, the messages scroll.

ISSUE	REASON	SOLUTION
Do not see Gases parameter tiles in display.	Parameter not configured to display.	Refer to "Display Options Dialog" on page 3-2 in the V Series Operating Instructions for additional information.

3.0

Regional Oxygen Saturation (rSO2) (Optional)

Introduction	3-2
rSO2 Configuration	3-2
rSO2 Setup	3-5
rSO2 Tiles.....	3-7
rSO2 Troubleshooting.....	3-9

3.1 Introduction

This chapter describes how to obtain Regional Oxygen Saturation (rSO₂) values from a INVOS 5100C System Monitor, and how to configure the alarm responses for this device at the **V 12/V 21** monitor.

The INVOS system provides non-invasive and continuous information of changes in regional oxygen saturation of blood. The measurement takes place in real time, providing an immediate indication of a change in the critical balance of regional oxygen delivery and oxygen consumption. Refer to the INVOS[®] 5100C Cerebral/Somatics Oximeter Operating Manual for parameter specifications.

Patient Sizes

Intended patient types: Adult, Pediatric, and Neonate.

VDI Module Connector

The VPS module does not include the rSO₂ parameter. The rSO₂ parameter is available through the serial port of a separate module called the V Device Integrator (VDI) (as shown in FIGURE 3-1).

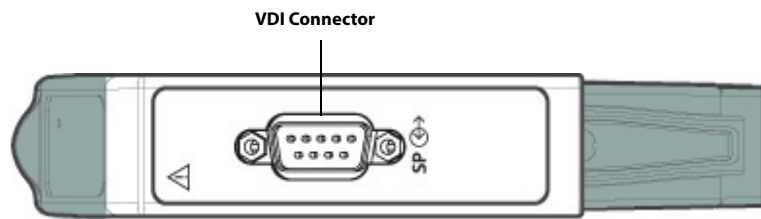

FIGURE 3-1 Example VDI Module Connector

Display Setup

To see the rSO₂, the rSO₂ tile must be configured to display on the Main Screen. Refer to "Display Options Dialog" on page 3-2 in the V Series Operating Instructions for additional information.

3.2 rSO₂ Configuration

The rSO₂ dialog (as shown in FIGURE 3-2) contains an **Alarms** tab and a **Setup** tab.

A description of each tab follows.

3.2.1 Navigating to the rSO₂ Dialog

- Select the rSO₂ digital tile.

OR

1. Select the **Setup** tab from the Navigation Area.
2. Select the **Parameters** button.
3. Select the **rSO₂** button.
The **rSO₂** dialog is displayed (as shown in FIGURE 3-2).

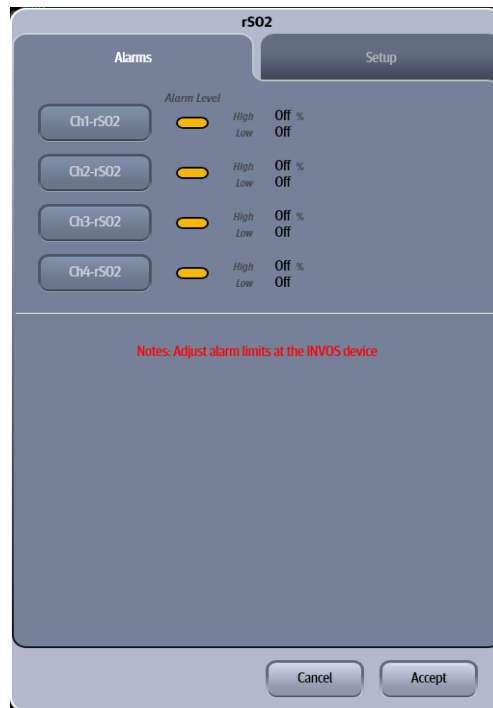

FIGURE 3-2 Example rSO2 Dialog (Alarms Tab)

3.2.2 Configuring rSO2 Alarms

The rSO2 alarm limits cannot be configured at the **V 12/V 21**. The alarm limits are configured at the INVOS device and displayed at the **V 12/V 21**. Refer to the INVOS 5100C System Operations Manual for additional information regarding alarm limits.

3.2.3 Alarm Responses: rSO2 Tab

To display the alarm responses for the **rSO2** tab:

- From the Navigation Area, select the **Alarm** tab > **Responses** button > **Oximetry** tab.

TABLE 3-1 contains the alarm responses for the rSO2 parameter.

TABLE 3-1

ALARM LEVELS BUTTON	ALARM LEVELS*			FACTORY DEFAULT ALARM RESPONSES		
	HIGH	MEDIUM	LOW	PRINT ON ALARM	SAVE TO EVENT	NURSE CALL
rSO2	X	X**	–	Off	On	Off

* X indicates available alarm level.

** The factory default configuration settings are in bold.

3.2.4 Configuring the rSO2 Parameter

- Select the rSO2 digital tile.

OR

1. Select the **Setup** tab from the Navigation Area.
2. Select the **Parameters** button.
3. Select the **rSO2** button.
The **rSO2** dialog displays.

NOTE: The current parameter setting displays in bold to the right of each button.

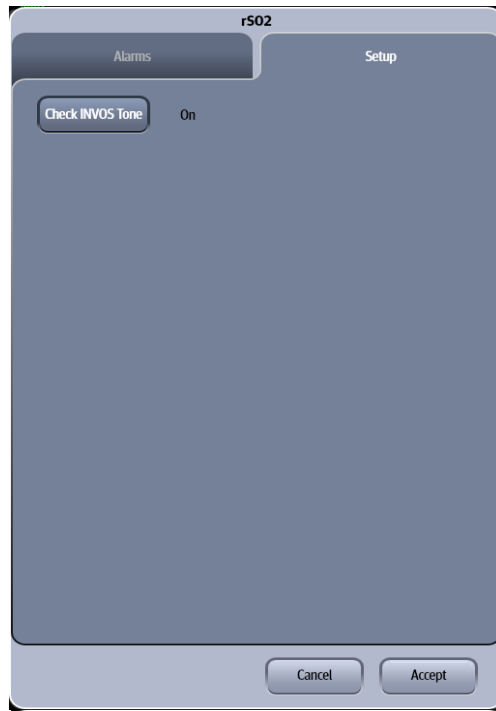

FIGURE 3-3 Example rSO2 Dialog (Setup Tab)

4. Select the buttons described in TABLE 3-2 to configure the tab.

TABLE 3-2

BUTTON	DESCRIPTION / COMMENTS	CHOICES*
Check INVOS Tone	Configures the monitor to sound a distinct audio tone when it obtains a Check INVOS technical message.	On , Off

* The factory default configuration settings are in bold.

5. Select the **Cancel** or **Accept** button.
 - The **Cancel** button closes the dialog without saving the settings.
 - The **Accept** button saves the settings and closes the dialog.

3.3 rSO2 Setup

3.3.1 INVOS Monitor

For questions regarding the use and maintenance of the INVOS[®] Monitors, refer to its operator's manual or contact Covidien for assistance. Within the USA: 800-635-5267, outside the USA: +353 1 438 1700.

The INVOS[®] Monitor uses harmless, near-infrared wavelengths which easily pass through the scalp and bone tissue beneath the sensor. Once connected to the patient, they are either absorbed or scattered back up to the sensor's shallow and deep detectors.

The type and quantity of absorption data returned to the detectors reflects relative amounts of deoxyhemoglobin and total hemoglobin, from which a regional oxygen saturation (rSO2) value unique to the specific area under the sensor is calculated. Values are measured continuously, with display screen updates provided to clinicians every five seconds.

The **V 12/V 21** interfaces with the INVOS[®] Monitor. This enables rSO2 data to be displayed and trended at the **V 12/V 21**, while providing alarm display and alarm responses configuration for the rSO2 parameter.

3.3.2 Connecting to an INVOS Monitor

The following are needed to connect the **V 12/V 21** to an INVOS Monitor:

- INVOS[®] Monitor
- One serial cable

NOTE: Use the serial cable supplied with the INVOS monitor to interface with the VDI module.

- One VDI module
- One 1x slot in the V Hub or Integrated V Hub

NOTE: Refer to "Module Status Dialog" on page 5-2 in the V Series Operating Instructions for additional information about 1x modules.

1. Connect the serial cable to an available COM port (as shown in FIGURE 3-4) on the back side of an INVOS Monitor.

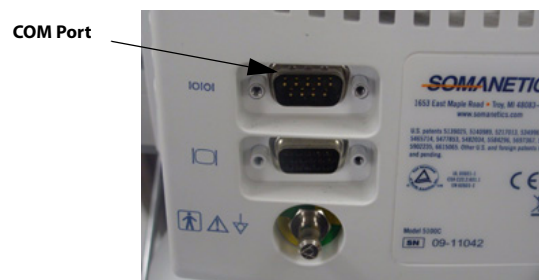

FIGURE 3-4 Example COM Port

2. Insert the VDI module into the V Hub or Integrated V Hub.
3. Connect the other end of the serial cable to the serial port on the VDI module.
4. Verify the current VDI mode is configured to Somanetics.

NOTE: Refer to "Changing VDI Modes" on page 5-4 of the V Series Operating Instructions for additional information.

5. Turn on the INVOS Monitor.

3.3.3 Configuring the INVOS Monitor Serial Port

Before configuring the **V 12/V 21** monitor to display rSO2, the INVOS Monitor serial port must be properly configured to communicate bidirectionally with the **V 12/V 21**. Using the operating instructions from the INVOS Monitor, verify the following serial port settings:

Baud Rate	9600
Parity	None
Stop Bits	1
Data Bits	8
Flow Control	Hardware

3.4 rSO2 Tiles

3.4.1 rSO2 Digital Tile Layout

The rSO2 digital tile displays:

1. Data channel label
2. Channel indicator
3. Upper and lower alarm limits
4. rSO2 values
5. Message area
6. rSO2 Baseline and values
7. Area Under Curve (AUC) values

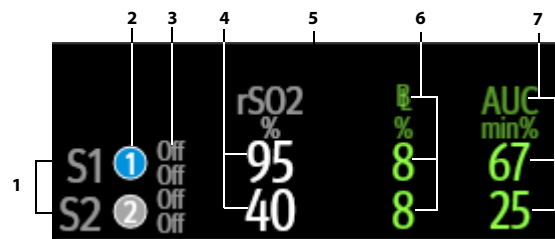

FIGURE 3-5 Example rSO2 Tile (Two-Channel Monitoring)

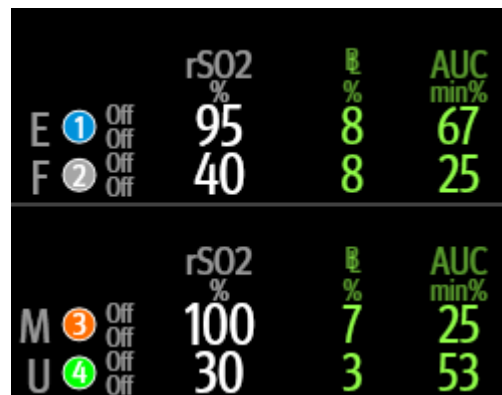

FIGURE 3-6 Example rSO2 Tile (Four-Channel Monitoring)

NOTE: Four-channel monitoring must be configured in the Display Setup in two separate tiles.

3.4.2 About the rSO2 Tile

- The rSO2 tile displays all (rSO2, BL, AUC) values in units of % with a resolution of 1%.
- If the rSO2 measurement is invalid, "--" displays in place of digits.
- rSO2 channel colors are represented as follows:
 - Channel 1 = blue
 - Channel 2 = grey
 - Channel 3 = orange
 - Channel 4 = green

3.4.3 rSO2 Alarms

The rSO2 alarm limits cannot be configured at the **V 12/V 21**. The alarm limits are configured at the INVOS device and displayed at the **V 12/V 21**. Refer to the INVOS 5100C System Operations Manual for additional information regarding alarm limits.

3.4.4 Message Area

The message area provides information about the current state of the rSO2 parameter. If there is more than one message to display, the messages scroll.

MESSAGE	DETAILS
<Channel Label>-rSO2 High Alarm Violation	Indicates that the current value for channel 1/2/3/4 is either equal to or higher than the set alarm limits.
<Channel Label>-rSO2 Low Alarm Violation	Indicates that the current value for channel 1/2/3/4 is either equal to or lower than the set alarm limits.
Check INVOS	Indicates the INVOS Monitor should be checked for a technical error.

3.5 rSO2 Troubleshooting

The rSO2 tile message area displays messages indicating the current state of the rSO2 parameter. If there is more than one message to display, the messages scroll.

ISSUE	REASON	SOLUTION
Dashes "--" display in place of numerics.	Measurement is invalid.	Check the sensor placement.
	VDI mode may be incorrect.	Change VDI mode to Somanetics.
Check INVOS	There has been at least 15 seconds of inactivity at the INVOS Monitor making the data at the V 12/V 21 monitor invalid.	The data at the V 12/V 21 automatically refreshes within seconds of the inactivity at the INVOS Monitor.
	Indicates there is an error on the INVOS Monitor that is not a physiological alarm.	Look at the INVOS Monitor for more detailed information.

This page intentionally left blank.

4.0

Mixed Venous Oxygen Saturation (SvO2) (Optional)

Introduction	4-2
SvO2 Configuration	4-3
SvO2 Setup	4-6
SvO2 Digital Tile Layout	4-8
SvO2 Troubleshooting	4-9

4.1 Introduction

This chapter describes the Mixed Venous Oxygen Saturation (SvO2) function in detail, including how to configure SvO2 alarm limits, monitor SvO2, and configure the SvO2 parameter.

Patient Sizes

Intended patient types: Adult and Pediatric.

VDI Module Connector

The VPS module does not include the SvO2 parameter. The SvO2 parameter is available through the serial port of a separate module called the V Device Integrator (VDI) (as shown in FIGURE 4-1).

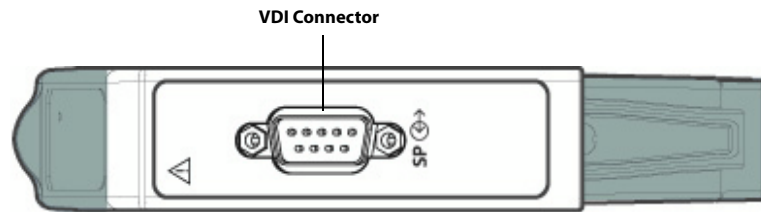

FIGURE 4-1 Example VDI Module Connector

Display Setup

To see the SvO2 values, SvO2 must be configured to display on the Main Screen. Refer to "Display Options Dialog" on page 3-2 in the V Series Operating Instructions for additional information.

4.2 SvO2 Configuration

The SvO2 dialog (as shown in FIGURE 4-2) contains an **Alarms** tab and a **Setup** tab. A description of each tab follows.

4.2.1 Navigating to the SvO2 Dialog

- Select the SvO2 digital tile.

OR

1. Select the **Setup** tab from the Navigation Area.
2. Select the **Parameters** button.
3. Select the **SvO2** button.
The **SvO2** dialog displays (as shown in FIGURE 4-2).

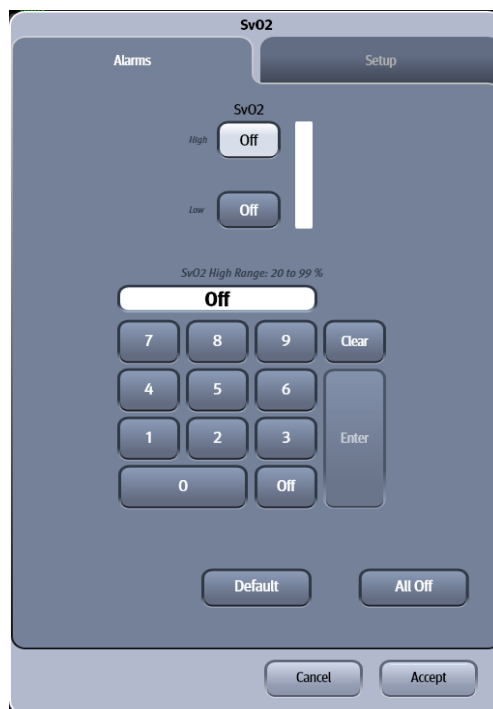

FIGURE 4-2 Example SvO2 Dialog (Alarms Tab)

4.2.2 Configuring SvO2 Alarms

For a full explanation about alarm responses and instructions for accessing and using these alarm dialogs, refer to the Alarms chapter in the V Series Operating Instructions.

4.2.2.1 Alarm Limits: CCO/Hemo Tab

TABLE 4-1 lists the alarm limit ranges for the SvO2 parameter, which are contained in the **CCO/Hemo** tab.

TABLE 4-1

PARAMETER	ALARM LIMIT	ADULT	PEDIATRIC	NEONATE
SvO2 Unit of Measure: % Resolution: 1% Invalid data: "--"	High Limit	Off , 20 to 99	Off , 20 to 99	N/A
	Low Limit	Off , 0 to 60	Off , 0 to 60	N/A

4.2.3 Alarm Responses: CCO/Hemo Tab

To display the alarm responses for the **CCO/Hemo** tab:

1. Select the **Alarm** tab from the Navigation Area.
2. Select the **Responses** button.
3. Select the **CCO/Hemo** tab.

TABLE 4-2 contains the alarm responses for the CCO/Hemo parameter.

TABLE 4-2

ALARM LEVELS BUTTON	ALARM LEVELS*			FACTORY DEFAULT ALARM RESPONSES		
	HIGH	MEDIUM	LOW	PRINTON ALARM	SAVE TO EVENT	NURSE CALL
SvO2	X	X	X	Off	On	Off

* X indicates available alarm level

** The factory default configuration settings are in bold.

4.2.4 Configuring the SvO2 Parameter

1. Select the SvO2 digital tile.
2. Select the **Setup** tab (as shown in FIGURE 4-3).

NOTE: The current parameter setting displays in bold to the right of each button.

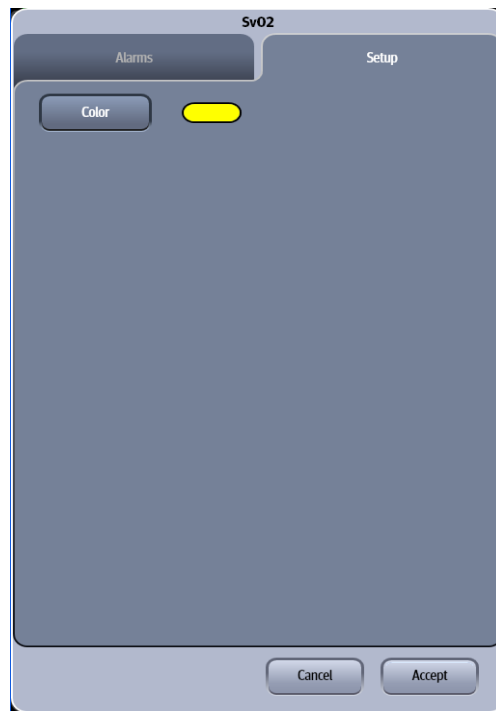

FIGURE 4-3 Example SvO2 Dialog (Setup Tab)

3. Select the buttons described in TABLE 4-3 to configure the tab.

TABLE 4-3

BUTTON	DESCRIPTION / COMMENTS	CHOICES*
Color	Configures the SvO2 parameter color.	There are 16 different colors available. The factory default is yellow .

* *The factory default configuration settings are in bold.*

4. Select the **Cancel** or **Accept** button.
- The **Cancel** button closes the dialog without saving the settings.
 - The **Accept** button saves the settings and closes the dialog.

4.3 SvO2 Setup

4.3.1 Edwards Lifesciences Monitors

For questions regarding the use and maintenance of the Edwards Vigilance[®], Vigilance II, the Vigileo[™], and the EV1000[™] monitors, refer to its operator's manual or contact Edwards Lifesciences Corporation for assistance. Within the USA: (800)-424-3278, outside the USA: (949)-250-2500.

The standard Edwards monitor measures both intermittent and continuous cardiac output (CCO) and T Blood. It can also be optionally configured to measure continuous mixed venous oxygen saturation (SvO₂). Intermittent CO uses the bolus thermodilution method, while continuous CO uses a pulmonary artery catheter to introduce small pulses of energy into the blood and then record the blood temperature. SvO₂ is measured by a spectrophotometric technique that uses light emitting diodes to transmit light in the red and infrared spectra through an optical fiber in a pulmonary artery catheter to the blood.

The **V 12/V 21** can interface with the Edwards Vigilance[®], Vigilance II, the Vigileo[™] and the EV1000[™]. This enables CO, T Blood and SvO₂ data to be displayed and trended at the **V 12/V 21**, while providing alarm control for these parameters. The **V 12/V 21** uses T Blood data from Edwards monitor to derive ΔT which can also be displayed and trended, as well as providing alarm control.

At the **V 12/V 21**, the CO value is divided by the patient's BSA (Body Surface Area) to calculate and display a corresponding cardiac index (CI). The BSA is determined from the patient's height and weight as entered in the **V 12/V 21**.

4.3.2 Connecting to the Edwards Monitor

The following are needed to connect the **V 12/V 21** to an Edwards monitor:

- Vigilance[®], Vigilance II, Vigileo[™], or EV1000[™]
- One serial cable

NOTE: Use the serial cable supplied with the Edwards monitor to interface with the VDI module.

- One VDI module
- One 1x slot in the V Hub or internal module bay

NOTE: Refer to "Module Status Dialog" on page 5-2 in the V Series Operating Instructions for additional information about 1x modules.

1. Connect the serial cable to an available COM port (as shown in FIGURE 4-4) on the back side of an Edwards monitor.

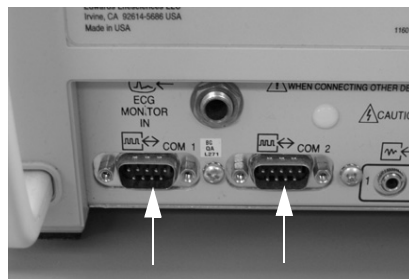

FIGURE 4-4 Example COM Port (Vigilance monitor shown in this example)

2. Insert the VDI module into the V Hub or module bay.

3. Connect the other end of the serial cable to serial port on the VDI module.
4. Turn on the Edwards monitor.

4.3.3 Configuring the Edwards Monitor Serial Port

Before configuring the **V 12/V 21** monitor to display SvO2, the Edwards monitor serial port must be properly configured to communicate bidirectionally with the **V 12/V 21**. Using the operating instructions from the Edwards monitor, verify the following:

Baud Rate	19200
Parity	None
Stop Bits	1
Data Bits	8
Flow Control	2 Seconds

4.4 SvO2 Digital Tile Layout

The SvO2 digital tile displays:

1. Tile name
2. Message area
3. SvO2 value
4. Units of measure
5. Alarm limits

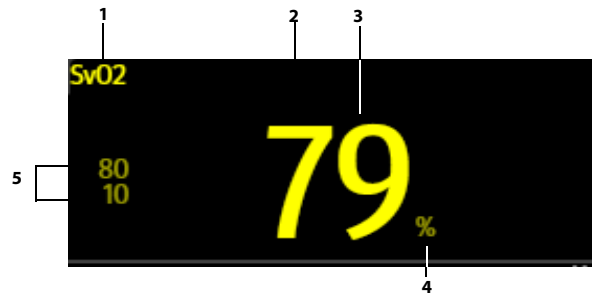

FIGURE 4-5 Example SvO2 Digital Tile

4.4.1 About the SvO2 Tile

- The SvO2 tile displays all SvO2 in units of % with a resolution of 1%.
- If the SvO2 measurement is invalid, "--" displays in place of digits.

4.4.2 SvO2 Alarms

Refer to the "Alarm Responses: CCO/Hemo Tab" on page 4-4 for additional information.

4.4.3 Message Area

The message area provides information about the current state of the SvO2 parameter. If there is more than one message to display, the messages scroll.

MESSAGE	DETAILS
SvO2 High Alarm Violation	Indicates that the current value is either equal to or higher than the set alarm limits.
SvO2 Low Alarm Violation	Indicates that the current value is either equal to or lower than the set alarm limits.
Check Vigilance	Indicates there is an error on the Edwards device that is not a physiological alarm. It is a prompt for the clinician to look at the Edwards device for more detailed information.

4.5 SvO2 Troubleshooting

The SvO2 tile message area displays messages indicating the current state of the SvO2 parameter. If there is more than one message to display, the messages scroll.

ISSUE	REASON	SOLUTION
Dashes "--" display in place of numerics.	Measurement is invalid.	Check catheter placement.

SHENZHEN MINDRAY BIO-MEDICAL ELECTRONICS CO., LTD. • Mindray Building, Keji 12th Road South, Hightech Industrial Park, Nanshan, Shenzhen 518057, P. R. • China. Tel: +86 (755) 26582888, 26582492 • Fax: +86 (755) 26582500, 26582501, 26582680

Mindray DS USA, Inc. • 800 MacArthur Boulevard • Mahwah, NJ 07430 • USA •
Dom. Customer Service: 1.800.288.2121 • Intl. Customer Service: +1.201.995.8000 •
Dom. Fax: 1.800.926.4275 • Intl. Fax: +1.201.995.8680 • www.mindray.com

Mindray Medical Canada Ltd. • 4250 Kingsway • Suite 206, Burnaby • BC, Canada V5H 4T7 •
Tel: (1-604) 451-1199 • Fax: (1-604) 451-1189 • Email: service@mindray.com

Mindray Medical Netherlands B.V. • Saturnusstraat 17, 2132HB Hoofddorp • The Netherlands •
Tel: (31-23) 574-9656 • Fax: (31-23) 574-9442 • Email: info.nl@mindray.com

Mindray (UK) Limited • 3 Percy Road • St. John's Park • Huntingdon • Cambs PE29 6SZ • United Kingdom •
Tel: (44-1480) 416-840 • Fax: (44-1480) 436-588 • Email: service@mindray.com

Mindray Medical France SARL • Europarc Créteil Cedex 123, Chemin des Bassins • 94000 Créteil • France •
Tel: (33-1) 4513-9145 • Fax: (33-1) 4513-9151 • Email: service@mindray.com

Mindray Medical German GmbH • Zwischen den Bächen 4 • 64625 Bensheim • Germany •
Tel: (49-6251) 17524-0 • Fax: (49-6251) 17524-20 • Email: service@mindray.com

Mindray Medikal Teknoloji Istanbul Ltd. • General Ali Riza Gürçan Cad. Metropol Center No:31 • A Blok K.13 D.52 Merter/Istanbul • Turkey • Tel: (90-212) 482-0877 • Fax: (90-212) 482-0878 •
Email: trservice@mindray.com

Mindray Medical Rus Co.Ltd. • 2 Zvenigorodskaya, 13, bld 41, 123022 • Moscow, Russia •
Tel: (7-499) 553-6036 • Fax: (7-499) 553-6039 • Email: service.ru@mindray.com

Mindray Medical Italy Srl. • Via Girardo Patecchio • 4 - 20141 Milano, Italy • Tel: (39-02) 57402 4444 • Fax: (39-02) 5523-2018 • Email: service@mindray.com

PT. Mindray Medical Indonesia • Menara Dea 1, Suite 301, Kav E4 No.3/1, Mega Kuningan, Jakarta Selatan 12950 • Indonesia • Tel: (62-21) 576-2650 • Fax: (62-21) 576-2655 • Email: service@mindray.com

Mindray Medical India Private Limited • No. 105, Sagar Pallazio, Saki Naka Junction • Mumbai • India • Tel: (91-22) 4245-0000 • Email: inservice@mindray.com

Mindray do Brasil • Comércio e Distribuição de Equipamentos Médicos Ltda., Rua Tavares Bastos, 329, Perdizes, São Paulo - SP, CEP 05012-020 • Brazil • Tel: (55-11) 3124-8026 • Fax: (55-11) 3078-8035 • Email: service.br@mindray.com

Mindray Medical Mexico S. de R. L. de C.V. • Insurgentes Sur # 1787 Piso 2, Col. Guadalupe Inn • México D.F. 01020 • Tel: (52-55) 5661-9450 / (52-55) 5662-6620 • Fax: (52-55) 5662-6567 • Email: forland.yang@mindray.com

SHENZHEN MINDRAY BIO-MEDICAL ELECTRONICS CO., LTD. • Mindray Building, Keji 12th Road South, Hightech Industrial Park, Nanshan, Shenzhen 518057, P. R. • China. Tel: +86 (755) 26582888, 26582492 • Fax: +86 (755) 26582500, 26582501, 26582680

Mindray DS USA, Inc. • 800 MacArthur Boulevard • Mahwah, NJ 07430 • USA •
Dom. Customer Service: 1.800.288.2121 • Intl. Customer Service: +1.201.995.8000 •
Dom. Fax: 1.800.926.4275 • Intl. Fax: +1.201.995.8680 • www.mindray.com

Mindray Medical Canada Ltd. • 4250 Kingsway • Suite 206, Burnaby • BC, Canada V5H 4T7 •
Tel: (1-604) 451-1199 • Fax: (1-604) 451-1189 • Email: service@mindray.com

Mindray Medical Netherlands B.V. • Saturnusstraat 17, 2132HB Hoofddorp • The Netherlands •
Tel: (31-23) 574-9656 • Fax: (31-23) 574-9442 • Email: info.nl@mindray.com

Mindray (UK) Limited • 3 Percy Road • St. John's Park • Huntingdon • Cambs PE29 6SZ • United Kingdom •
Tel: (44-1480) 416-840 • Fax: (44-1480) 436-588 • Email: service@mindray.com

Mindray Medical France SARL • Europarc Créteil Cedex 123, Chemin des Bassins • 94000 Créteil • France •
Tel: (33-1) 4513-9145 • Fax: (33-1) 4513-9151 • Email: service@mindray.com

Mindray Medical German GmbH • Zwischen den Bächen 4 • 64625 Bensheim • Germany •
Tel: (49-6251) 17524-0 • Fax: (49-6251) 17524-20 • Email: service@mindray.com

Mindray Medikal Teknoloji Istanbul Ltd. • General Ali Riza Gürçan Cad. Metropol Center No:31 • A Blok K. 13 D.52 Merter/Istanbul • Turkey • Tel: (90-212) 482-0877 • Fax: (90-212) 482-0878 •
Email: trservice@mindray.com

Mindray Medical Rus Co.Ltd. • 2 Zvenigorodskaya, 13, bld 41, 123022 • Moscow, Russia •
Tel: (7-499) 553-6036 • Fax: (7-499) 553-6039 • Email: service.ru@mindray.com

Mindray Medical Italy Srl. • Via Girardo Patecchio • 4 - 20141 Milano, Italy • Tel: (39-02) 57402 4444 • Fax: (39-02) 5523-2018 • Email: service@mindray.com

PT. Mindray Medical Indonesia • Menara Dea 1, Suite 301, Kav E4 No.3/1, Mega Kuningan, Jakarta Selatan 12950 • Indonesia • Tel: (62-21) 576-2650 • Fax: (62-21) 576-2655 • Email: service@mindray.com

Mindray Medical India Private Limited • No. 105, Sagar Pallazio, Saki Naka Junction • Mumbai • India • Tel: (91-22) 4245-0000 • Email: inservice@mindray.com

Mindray do Brasil • Comércio e Distribuição de Equipamentos Médicos Ltda., Rua Tavares Bastos, 329, Perdizes, São Paulo - SP, CEP 05012-020 • Brazil • Tel: (55-11) 3124-8026 • Fax: (55-11) 3078-8035 • Email: service.br@mindray.com

Mindray Medical Mexico S. de R. L. de C.V. • Insurgentes Sur # 1787 Piso 2, Col. Guadalupe Inn • México D.F. 01020 • Tel: (52-55) 5661-9450 / (52-55) 5662-6620 • Fax: (52-55) 5662-6567 • Email: forland.yang@mindray.com
